

LIBRARY  
ANNEX

2

THE MICROSCOPY OF  
DRINKING WATER

---

GEORGE C. WHIPPLE

**Cornell University Library**

BOUGHT WITH THE INCOME  
FROM THE  
SAGE ENDOWMENT FUND  
THE GIFT OF  
**Henry W. Sage**  
1891

A.287421

1917/14

Cornell University Library

TD 384.W58

The microscopy of drinking water,



3 1924 003 633 801

main



# Cornell University Library

The original of this book is in  
the Cornell University Library.

There are no known copyright restrictions in  
the United States on the use of the text.

# THE MICROSCOPY OF DRINKING WATER

BY

GEORGE CHANDLER WHIPPLE

GORDON MCKAY PROFESSOR OF SANITARY ENGINEERING, HARVARD UNIVERSITY

AND THE

MASSACHUSETTS INSTITUTE OF TECHNOLOGY

WITH A CHAPTER ON

THE USE OF THE MICROSCOPE

By JOHN W. M. BUNKER, Ph.D.

*THIRD EDITION, REWRITTEN AND ENLARGED*

*WITH COLORED PLATES*

FIRST THOUSAND

NEW YORK

JOHN WILEY & SONS, INC.

LONDON: CHAPMAN & HALL, LIMITED

1914

A

Copyright, 1899, 1905, 1914

BY

GEORGE CHANDLER WHIPPLE

8170

D66(2)

A.2 874 21

**WORKS OF G. C. WHIPPLE**

PUBLISHED BY

**JOHN WILEY & SONS, Inc.**

**The Microscopy of Drinking-water.**

Third edition, rewritten. 8vo, xxi+409 pages, 73 figures and 6 plates in the text and 19 full-page plates in colors. Cloth, \$4.00 net.

**The Value of Pure Water.**

Large 12mo, viii+84 pages. Cloth, \$1.00.

**Typhoid Fever—Its Causation, Transmission and Prevention.**

Introduction by WILLIAM T. SEDGWICK, Ph.D.  
Large 12mo, xxxvi+407 pages, 50 figures. Cloth, \$3.00 net.

THE SCIENTIFIC PRESS  
ROBERT DRUMMOND AND COMPANY  
BROOKLYN, N. Y.



View Showing the Aerator of the Little River Water-supply at Springfield, Mass., the Administration Building, and the Regulator House of the Filter. Hazen and Whipple, Consulting Engineers.

(Courtesy of Mr. Filbert E. Lochridge, Chief Engineer.)

*Frontispiece.*







DEDICATED  
TO  
MY FATHER AND MOTHER



## PREFACE

---

THIS book has a twofold purpose. It is intended primarily to serve as a guide to the water analyst and the water-works engineer, describing the methods of microscopical examination, assisting in the identification of the common microscopic organisms found in drinking water and interpreting the results in the light of environmental studies. Its second purpose is to stimulate a greater interest in the study of microscopic aquatic life and general limnology from the practical and economic standpoint.

The work is elementary in character. Principles are stated and briefly illustrated, but no attempt is made to present even a summary of the great mass of data that has accumulated upon the subject during the last decade. The illustrations have been drawn largely from biological researches made at the laboratory of the Boston Water Works and from the reports of the Massachusetts State Board of Health. In considering them one should remember that the environmental conditions of the Massachusetts water-supplies are not universal, and that every water-supply must be studied from the standpoint of its own surroundings. As far as the microscopic organisms are concerned, however, the troubles that they have caused in Massachusetts may be considered as typical of those experienced elsewhere.

The descriptions of the organisms in Part II are necessarily brief and limited in number. The organisms chosen for description are those that are most common in the water-supplies of New England, and those that best illustrate the most important groups of microscopic animals and plants. In many cases whole

families and even orders have been omitted, and some readers will doubtless look in vain for organisms that to them seem important. The omissions have been made advisedly and with the purpose of bringing the field of microscopic aquatic life within the scope of a practical and elementary survey. For the same reason the descriptions stop at the genus and no attempt has been made to describe species and varieties. Notwithstanding this it is believed that the illustrations and descriptions are complete enough to enable the general reader to obtain a true conception of the nature of the microscopic life in drinking water and to appreciate its practical importance. To the student they must serve as a skeleton outline upon which to base more detailed study.

The illustrations, for the greater part, have been drawn from living specimens or from photo-micrographs of living specimens, but some of them have been reproduced from published works of standard authority. Among these may be mentioned: Pelletan and Wollé on the Diatomaceæ; Wollé, Rabenhorst, and Cooke on the Chlorophyceæ and Cyanophyceæ; Zopf on the Fungi; Leidy, Bütschli, and Kent on the Protozoa; Hudson and Goss on the Rotifera; Baird and Herrick on the Crustacea; Lankester on the Bryozoa; Potts on the Spongidæ; and Griffith and Henry on miscellaneous organisms.

This book has been prepared during the leisure moments of a busy year. Its completion has been made possible by the kind assistance of my present and former associates in the laboratories of the Boston and Brooklyn water-supply departments and of other esteemed friends, to all of whom I tender my sincere thanks. I desire also to acknowledge the valuable assistance of my wife, Mary R. Whipple, in revising the manuscript and correcting the proof. To many others I am indebted indirectly, and among them I cannot refrain from mentioning the names of Prof. W. T. Sedgwick of the Massachusetts Institute of Technology; Mr. Geo. W. Rafter, C.E., of Rochester, N. Y.; and Mr. Desmond FitzGerald, C.E., formerly Superintendent of the Boston Water Works and now Engineer of the Sudbury Department of the Metropolitan Water Works. To

Prof. Sedgwick and Mr. Rafter water analysts are indebted for the most satisfactory practical method of microscopical examination of drinking water yet devised, and Mr. FitzGerald will be remembered not only as an eminent engineer but as the founder and patron of the first municipal laboratory for biological water-analysis in this country.

GEORGE CHANDLER WHIPPLE.

NEW YORK, January, 1899.



## PREFACE TO THE THIRD EDITION

---

IN reviewing the scientific literature incident to the preparation of this third edition of the *Microscopy of Drinking Water*, the author has been amazed at the enormous amount of work that has been devoted to the study of the microscopic organisms, both in this country and abroad, since he first became interested in the subject more than twenty years ago. But with all the work that has been done, the mystery of the comings and goings of the algæ and the protozoa in our lakes and reservoirs still remains unsolved. Yet it cannot be said that no progress has been made, for our studies have at least made clearer some of the laws which control the circulation of water in lakes, the effect which this circulation, or the absence of it, has upon the dissolved gases, and the relation which exists between such gases as oxygen and carbonic acid and the presence of microscopic chlorophyllaceous plants. We have, too, a better idea of the effect which the seasonal changes in the viscosity of water have upon the distribution and even upon the shape of some of the plankton.

If, leaving the natural history of the subject, we turn our attention to its practical aspect and consider the artificial means of controlling plankton growths and the purification of water containing them, we find that gratifying progress has been made. The copper sulphate treatment has proved to be conspicuously successful as a means of eradicating algæ. The free use of aeration has been demonstrated to be beneficial in the removal of tastes and odors from algæ-laden water and necessary to its successful filtration. The stripping of soil from reservoir sites has been found to reduce growths of algæ,

but not to prevent them entirely. The important part played by the plankton in the self-purification of polluted waters has been established. All of these matters are of great practical importance to the human race.

The Sedgwick-Rafter method has become almost universally used by American water analysts. The principal modifications here suggested relate to its more convenient use in the field. The sling filter affords a rapid and satisfactory means of concentrating the organisms, while the round cell is much cheaper than the original rectangular form. The cotton filter is another useful innovation.

The first part of the book has been rewritten. New material has been inserted in almost every chapter and several new chapters have been added, the most important being on the copper treatment, the stripping of reservoir sites, the purification of algæ-laden water, and the use of the microscope and photomicrography. The last named chapter was written by Dr. John W. M. Bunker, Instructor in Sanitary Analysis in Harvard University. In this chapter free use has been made of Edward Bausch's excellent little hand-book on the "Use of the Microscope," with the kind permission of the Bausch & Lomb Optical Company. The data on soil stripping have been taken largely from the report made by Messrs. Allen Hazen and George W. Fuller to the chief engineer of the Board of Water Supply of New York City.

The plates showing the common organisms found in water-supplies have been printed in colors, thus making the identification of the organisms somewhat easier. For this color work the author is again indebted to Dr. Bunker. It is a matter of regret that a larger number of organisms could not have been depicted and described, but this could not have been done without unduly increasing the cost of the book.

The bibliography which occupied more than twenty pages in the preceding editions has been abridged. To have brought it up to date would have required at least a hundred pages. A few references chosen with regard to their value to students, are given at the end of some of the chapters.

In bringing this preface to a close the author wishes to express his conviction that the micrology of water is going to play an increasingly important part in the science of sanitation. The demand for clean water is growing. Popular standards of purity are rising. Our cities need water of such quality that the people not only can drink it with safety, but will drink it with pleasure. "Safety first" is as good a motto for the water-supply service as it is for railroad service, but safe water that is not also clean loses, psychologically, much of its value.

In the interest of clean water it is hoped that the study of the microscopic organisms will not be confined to specialists, but will be undertaken by all superintendents of water-works, who are in charge of storage reservoirs. It is for such men and for students of water analysis that this book has been especially prepared.

G. C. W.

CAMBRIDGE, MASS., January 1, 1914.



# CONTENTS

---

## PART I

### CHAPTER I

	PAGE
HISTORICAL.....	I

### CHAPTER II

THE OBJECT OF THE MICROSCOPICAL EXAMINATION.....	8
--	---

### CHAPTER III

COLLECTION OF SAMPLES.....	14
----------------------------	----

### CHAPTER IV

METHODS OF MICROSCOPICAL EXAMINATION.....	28
---	----

### CHAPTER V

THE MICROSCOPE AND ITS USE. PHOTOMICROGRAPHY.....	49
---	----

### CHAPTER VI

MICROSCOPIC ORGANISMS IN WATER FROM DIFFERENT SOURCES.....	73
--	----

### CHAPTER VII

LIMNOLOGY.....	83
----------------	----

### CHAPTER VIII

DISSOLVED GASES AND THEIR RELATIONS TO THE MICROSCOPIC ORGANISMS.....	117
---	-----

	PAGE
CHAPTER IX	
OCCURRENCE OF MICROSCOPIC ORGANISMS IN LAKES AND RESERVOIRS.....	133
CHAPTER X	
SEASONAL DISTRIBUTION OF MICROSCOPIC ORGANISMS.....	164
CHAPTER XI	
HORIZONTAL AND VERTICAL DISTRIBUTION OF MICROSCOPIC ORGANISMS....	175
CHAPTER XII	
ODORS IN WATER-SUPPLIES.....	186
CHAPTER XIII	
STORAGE OF SURFACE WATERS.....	206
CHAPTER XIV	
SOIL STRIPPING.....	218
CHAPTER XV	
STORAGE OF GROUND WATER.....	246
CHAPTER XVI	
COPPER TREATMENT FOR ALGAE.....	251
CHAPTER XVII	
PURIFICATION OF WATER CONTAINING ALGAE.....	261
CHAPTER XVIII	
GROWTH OF ORGANISMS IN WATER PIPES.....	277

## PART II

## CHAPTER XIX

	PAGE
CLASSIFICATION OF THE MICROSCOPIC ORGANISMS.....	286

## CHAPTER XX

DIATOMACEAE.....	291
------------------	-----

## CHAPTER XXI

SCHIZOMYCETES. THE IRON BACTERIA.....	312
---------------------------------------	-----

## CHAPTER XXII

CYANOPHYCEAE.....	316
-------------------	-----

## CHAPTER XXIII

CHLOROPHYCEAE.....	325
--------------------	-----

## CHAPTER XXIV

FUNGI.....	341
------------	-----

## CHAPTER XXV

PROTOZOA.....	344
---------------	-----

## CHAPTER XXVI

ROTIFERA.....	365
---------------	-----

## CHAPTER XXVII

CRUSTACEA.....	373
----------------	-----

## CHAPTER XXVIII

BRYOZOA, OR POLYZOA.....	378
--------------------------	-----

## CHAPTER XXIX

	PAGE
SPONGIDAE.....	381

## CHAPTER XXX

MISCELLANEOUS ORGANISMS.....	384
GLOSSARY.....	387
TABLES AND FORMULÆ.....	391
SCIENTIFIC LITERATURE.....	393
INDEX.....	401

## LIST OF ILLUSTRATIONS

---

Aerator at the Springfield Filter.....	Frontispiece
No.	PAGE
1. Whipple's Apparatus for Collecting Samples.....	15
2. Steuer's Sample Collecting Rig.....	16
3. Steuer's Stopper Attachment.....	17
4. Eurich's Stopper.....	18
5. Eurich's Stopper with cap on.....	19
6. Eurich's Stopper with cap off.....	19
7. Strainer Jar.....	20
8. Plankton Net.....	21
9. Plankton Pump.....	24
10. Bottle for Collecting Dissolved Oxygen Samples.....	26
11. Sedgwick-Rafter Funnel.....	29
12. Battery of Filters.....	30
13. Revolving Stand for Filters.....	31
14. Sling Filter.....	33
15. Concentrating Attachment.....	34
16. Counting Cell.....	35
17. New Form of Counting Cell.....	35
18. Ocular Micrometer.....	36
19. Wizard Sediment Tester.....	47
20. Air Compressor for Sediment Tester.....	48
21. Compound Microscope Stand.....	50
22. Optics of Simple Magnification.....	57
23. Optics of Compound Microscope.....	58
24. Use of Plane and Concave Mirrors.....	59
25. Use of the Condenser.....	60
26. Use of Plane and Concave Mirrors with Condensers.....	60
27. Leitz Step Micrometer.....	64
28. Abbé Camera Lucida.....	65
29. Photomicrographic Camera.....	66
30. Edinger Drawing and Projecting Apparatus.....	67
31. Demonstration Eye-piece.....	68

No.	PAGE
32. Microscope for Water Examination.....	69
33. Portable Microscope.....	70
34. Field Work at Squam Lake.....	71
35. Weighted Thermometer Case.....	86
36. Thermophone.....	88
37. Temperatures at Lake Cochituate.....	90
38. Temperatures in Frozen Lakes.....	93
39. Temperature of Lake Cochituate in Summer.....	95
40. Temperatures at Squam Lake.....	96
41. Temperatures at Squam Lake.....	97
42. Cross-section of Lake, showing Transition Zone.....	98
43. Classification of Lakes according to Temperature.....	99
44. Classification of Lakes according to Temperature.....	100
45. Horizontal Currents in a Lake.....	105
46. U. S. Geological Survey Color Apparatus.....	108
47. U. S. Geological Survey Turbidity Rod.....	112
48. Disk for Comparing Transparencies of Waters.....	115
49. Dissolved Oxygen and Carbonic Acid in Fresh Pond.....	129
50. Dissolved Oxygen in Lake Mendota.....	130
51. Organisms in Genesee River.....	161
52. Seasonal Distribution of Organisms in Lake Cochituate.....	164
53. Succession of Diatoms in Chestnut Hill Reservoir.....	166
54. Growth of Diatoms and Intensity of Light.....	167
55. Seasonal Distribution of Diatoms and Blue Green Algæ.....	174
56. Hyalodaphnia, changes in shape.....	182
57. Anuræa, changes in shape.....	182
58. Vertical Distribution of Organisms.....	183
59. Aesthetic Deficiency of Water.....	202
60. Stagnation Effects, Lake Cochituate.....	212
61. Organisms in Baiseleys Pond.....	216
62. Aeration at Sodom Dam.....	264
63. Spillway at Croton Dam.....	266
64. Aeration at Albany, N. Y.....	266
65. Sprinkling Fitters at Baltimore.....	267
66. Aeration at Ludlow Filters, Springfield.....	267
67. Aerator at Rye Pond.....	268
68. Aerator at Rye Pond.....	268
69. Newcomb Filter.....	275
70. Temperature of Water in Pipes.....	277
71. Organisms in Boston Water Pipes.....	279
72. Construction of Diatom Cell.....	295
73. Iron Bacteria.....	314

## PLATES IN TEXT

No.	PAGE
A. Sediment in Cambridge Water.....	opposite 48
B. Photo-micrographs of Organisms.....	298
C. Photo-micrographs of Organisms.....	317
D. Photo-micrographs of Organisms.....	326
E. Photo-micrographs of Organisms.....	335
F. Photo-micrographs of Organisms.....	346

## PLATES AT END OF VOLUME

- I. Diatomaceæ.
- II. Diatomaceæ.
- III. Diatomaceæ.
- IV. Schizomycetes. Cyanophyceæ.
- V. Cyanophyceæ. Chlorophyceæ.
- VI. Chlorophyceæ.
- VII. Chlorophyceæ.
- VIII. Chlorophyceæ.
- IX. Chlorophyceæ.
- X. Chlorophyceæ. Fungi.
- XI. Fungi. Protozoa.
- XII. Protozoa.
- XIII. Protozoa.
- XIV. Protozoa. Rotifera.
- XV. Protozoa. Rotifera.
- XVI. Rotifera.
- XVII. Rotifera. Crustacea.
- XVIII. Crustacea. Bryozoa. Spongidaæ.
- XIX. Miscellaneous.



# THE MICROSCOPY OF DRINKING WATER

---

## PART I

---

### CHAPTER I

#### HISTORICAL

THE study of the microscopic organisms in water dates back to the seventeenth century. With the invention of the compound microscope enthusiastic observers began to search ponds and streams and ditches for new and varied kinds of microscopic life. Among the pioneers in this field of Natural History were Hooke, 1665; Leeuwenhoek, 1675; Ray, 1724; Hudson, 1762; Müller, 1773; Dillwyn, 1809; Kützing, 1834; Ehrenberg, 1836; Dujardin, 1841; and Stein, 1849.

It was not until 1850 that the study of the organisms in drinking water was recognized as having a practical sanitary value. Dr. Hassall of London was the first to call attention to it. His method of procedure is unknown, but in all probability it consisted of the examination of a few drops of the sediment collected in a deep vessel after allowing the water to stand for a longer or shorter interval. Radlkofer, 1865, of Munich, and Cohn, 1870, Hirt, 1879 and Hulwa of Breslau, pursued the study and emphasized its importance, but they made no radical improvement in the method.

In 1875 Dr. J. D. Macdonald, of London, suggested improvements in the sedimentation method, and made a rude attempt to obtain quantitative results by allowing the water to settle for a definite length of time, collecting the sediment on a removable glass disk or watch-glass at the bottom of a tall jar, and afterward transferring this glass disk with its accumulated sediment to the stage of the microscope for direct examination.

In 1884 Dr. H. C. Sorby, of England, attempted to obtain a more exact enumeration by passing a gallon of the sample through a fine sieve (200 meshes to an inch) and then washing the collected organisms into a dish and in some way counting them.

In America important researches were made by Torrey, Vorce, Mills, Leeds, Potts, Nichols, Farlow, and others, but previous to 1888 the work was chiefly of a qualitative character.

**American Investigations.** In 1887 the Massachusetts State Board of Health began a systematic examination of all the water-supplies of the State, which has been maintained for twenty-five years. Two years later the State Board of Health of Connecticut began a similar but less extensive series of examinations. In 1889 the Water Board of the City of Boston established a biological laboratory at the Chestnut Hill reservoir for the purpose of studying systematically the biological character of the various sources of supply. For the first eight years of its existence it was conducted by the author under the general direction of Mr. Desmond FitzGerald, Superintendent of the Western Division of the Boston Water Works. Subsequent biologists in charge of this laboratory have been Dr. F. S. Hollis, Horatio N. Parker, Edward P. Walters, A. W. Walker and Charles E. Livermore. After the water-supply of Boston came under the control of the Metropolitan Water Board this laboratory was removed to No. 1 Ashburton Place where it is still in operation.

In 1893 a small laboratory was established by the Public Water Board of the City of Lynn, Mass. In 1897 Mt. Prospect Laboratory, connected with the Department of Water Supply of Brooklyn, N. Y., was equipped and put in operation. It was

devoted to general water-analysis, and the microscopical examination of water from the different sources of supply formed an important part of the routine work. After Brooklyn became a part of Greater New York, in 1898, the work of this laboratory was extended to cover all the water-supplies of the city, and branch laboratories were established on the Croton and Ridge-wood watersheds. From 1897 to 1904 these laboratories were under the direction of the author; from 1904 to 1913 under the direction of D. D. Jackson, and now are in charge of Dr. Frank E. Hale.

Similar biological work has since been undertaken by boards of health and water departments and by sanitary experts in all parts of the world.

The method of microscopical examination first used by the Massachusetts State Board of Health was that suggested by Prof. G. H. Parker, now of Harvard University. A piece of cotton cloth was tied firmly over the end of a glass funnel and 200 c.c. of the sample were made to pass through it. The organisms were left as a deposit on the cloth. After this straining the cloth was removed and inverted over an ordinary microscopical slip. The organisms, together with a small quantity of water, were dislodged upon the slip by blowing downward upon the cloth through a piece of glass tube. This method was useful, but it did not give accurate quantitative results. Mr. F. F. Forbes, of Brookline, Mass., used a modification of the cloth method. The water was filtered as in Parker's method, but the neck of the funnel passed into a tank from which the air was exhausted by an aspirator. This hastened the filtration and allowed a larger amount of water to be filtered.

The present method of examination was foreshadowed in the work of Mr. A. L. Kean. He filtered 100 c.c. of his samples through a small quantity of coarse sand placed at the bottom of a glass funnel and supported by a plug of wire gauze. After filtration the plug was removed and the sand with its contained organisms was washed into a watch-glass with 1 c.c. of water. This was stirred up to separate the organisms from the sand and a portion was transferred to a cell holding one cubic milli-

meter. From the number of organisms found in this cell the approximate number originally present in the water could be obtained. This method became known as the "sand method."

In 1889 Prof. W. T. Sedgwick, of the Massachusetts Institute of Technology, and Mr. Geo. W. Rafter, of Rochester, made valuable improvements upon Kean's original idea. Prof. Sedgwick suggested the use of a cell much larger than that used by Kean, bounded by a brass rim and having an area of 1000 square millimeters ruled by a dividing engine into 1000 squares. The filtration was made as before, and the sand was washed into the cell with one or two cubic centimeters of water and distributed over the bottom. The cell was then placed under the microscope and the organisms counted in a certain number of the small squares. From this count the number of organisms present in the sample was estimated. A modification of this method was the one first used by the Connecticut State Board of Health. In the Connecticut method precipitated silica was used instead of sand for the filtering medium, and this was supported upon a plug of absorbent cotton.

Mr. Rafter's improvements consisted in the substitution of a ruled square in the ocular of the microscope for the ruling upon the plate, in the separation of the sand from the organisms by decantation, in the use of a cell covered by a cover-glass and containing just one cubic centimeter, and in the use of a specially constructed mechanical stage. The Sedgwick-Rafter method has been modified somewhat by recent experimenters, but its essential character has not been changed.

Dr. Gary N. Calkins substituted a perforated rubber stopper capped by a circle of bolting-cloth in place of the plug of wire gauze. Mr. D. D. Jackson suggested a cylindrical funnel in place of the ordinary flaring chemical funnel, and added an attachment at the lower end to control the concentration and prevent the sand from becoming dry. The author has graduated the funnels, designed a simple automatic concentrating device, applied an aspirator to hasten the filtration and devised the portable sling filter for field work. He also designed the ocular micrometer and the record blank now used, and suggested the

idea of a standard unit of size for estimating the organisms and amorphous matter. Dr. J. W. M. Bunker has devised a convenient stand for the filters and a cheap circular cell.

**European Plankton Studies.**—While sanitarians were pursuing the study of the microscopic organisms because of their effect on the quality of water-supplies, other scientists have approached the subject from an entirely different standpoint. In 1887, the same year in which the Massachusetts State Board of Health began its examination of the water-supplies of the State, Victor Hensen of the University of Kiel, Germany, published a description of a new method of studying the minute floating organisms found in lakes. To these organisms he gave the name "plankton," from the Greek word *planktos*, which means "wandering." This collective word was applied to all of the minute animals and plants that float free in the water and that are drifted about by waves and currents. Plants attached to the shore, and animals that possess strong powers of locomotion, were not included in the plankton, but fragments of shore plants, fish-eggs, young fish-fry, and the like, were included. The term may be said to be practically synonymous with the term "microscopic organisms" of the sanitary biologist.

Hensen's method was radically different from the Sedgwick-Rafter method. It consisted of a net by which the organisms could be concentrated in the field, so that only the collected material need be taken to the laboratory. The plankton net has been much improved in recent years.

Even before the publication of Hensen's paper, scientists on the Continent had become interested in the study of lakes. The work of Prof. F. A. Forel, of Morges, Switzerland, on Lake Geneva described in "Le Lemman" was epoch making. It was followed by the establishment of a Limnological Commission in Switzerland, under the direction of which many valuable lines of physical and biological research were undertaken. This was followed in 1890 by an International Commission. From this time increased attention has been given to the biology of ponds and lakes. A biological station was established by Zacharias at Lake Plön in 1891, and a group of scientists

have contributed a long series of important articles to its reports which have been published annually since 1893. Apstein at Kiel, Schroeter at Zurich, Wesenburg-Lund in Denmark and many others have made extensive and valuable observations. Biological stations have multiplied during recent years, and the work has extended to France, Italy, Austria, Denmark, Norway, Scotland and other countries.

Special attention should be called to the work of Sir John Murray and his associates in Scotland. The results of their studies are embodied in a recently published work, entitled "Bathymetrical Studies of the Scottish Lakes." The European writings on the subject are now very voluminous. Abstracts of most of the important articles may be found in the "International Revue der Gesammten Hydrobiologie und Hydrographie," a monthly journal edited by R. Woltereck and published by Dr. Werner Klinkhardt at Leipzig.\*

Another very valuable source of information is the laboratory of the Königlichen Landesanstalt für Wasserhygiene in Berlin-Dahlem. The "Mitteilungen" published under the direction of Dr. Rudolf Abel and Dr. Carl Günther contain many articles relating to limnology and the micrology of water.

**Plankton Studies in the United States.**—Similar investigations have been carried on in the United States. In 1893 Prof. J. E. Reighard, acting under the direction of the Michigan Fish Commission, made a biological study of Lake St. Clair. This was followed by an examination of Lake Michigan by Prof. Henry B. Ward, and by studies of the crustacea in Lake Mendota by Prof. E. A. Birge, and in Green Lake by Prof. C. Dwight Marsh.

Biological stations were soon established by a number of western universities on or in the vicinity of the Great Lakes, and on the shores of smaller bodies of water.

Summer-school courses in planktology and general microscopic ecology are given at these stations. In 1900 an American Limnological Commission composed of Dr. E. A. Birge, Dr. H.

\* This can be obtained from G. E. Stechert & Co. 129 West 20th St., New York City.

B. Ward, Dr. Charles A. Kofoid, Dr. C. H. Eigenmen, and George C. Whipple, was organized for the purpose of stimulating scientific work along the various lines of natural science involved, and of co-ordinating the work of various individuals and institutions.

This commission, not receiving proper support, was discontinued, but its work resulted in increased individual activity. Dr. Kofoid carried on an extensive investigation of the plankton of the Illinois River, and Dr. Birge and Dr. Juday have made most valuable studies of the temperature of lakes and the gases dissolved in lake waters at different depths.

For several years the late Prof. James I. Peck, acting under the direction of the U. S. Fish Commission, made important studies of the food of certain fishes, notably the menhaden. He used the Sedgwick-Rafter method instead of the plankton net for concentrating the microscopic organisms. This method has also been used in the study of the food supply of oysters.

In 1896 Dr. C. S. Dolley, of Philadelphia, suggested the use of the centrifugal machine for the purpose of concentrating the microscopic organisms. This "planktonokrit," as it is called, has not been developed to completeness, but was studied by Field, Kofoid, and others.

Prof. H. B. Ward and Mr. Chas. Fordyce devised a plankton pump for collecting crustacea and other plankton organisms at particular depths below the surface of a lake. In many ways this was a decided improvement over the plankton net.

These special methods have more value for strictly scientific studies of the organisms than for the practical uses of the water analyst or the sanitary expert.

The extensive investigations of the Massachusetts State Board of Health and the Metropolitan Water Board of Boston begun nearly a quarter of a century ago are still being continued, as well as those of the water department of New York City.

Important advances have also been made in the direction of controlling the growths of algæ in reservoirs and the purification of water containing microscopic organisms.

## CHAPTER II

### THE OBJECT OF THE MICROSCOPICAL EXAMINATION

A COMPLETE sanitary examination of water, as conducted in modern laboratories, consists of four parts—the physical, the microscopical, the bacteriological, and the chemical analysis. For a description of the methods of analysis the reader is referred to the Report of the Committee on Standard Methods of Water Analysis of the American Public Health Association, Revised in 1912.\* The data commonly obtained by these analyses are as follows:

#### PHYSICAL EXAMINATION.

Temperature—Turbidity—Color—Odor (both cold and hot).

#### MICROSCOPICAL EXAMINATION.

Quantity of microscopic organisms per c.c.—Amount of inorganic matter, amorphous matter, etc.

#### BACTERIOLOGICAL EXAMINATION.

Number of bacteria per c.c.—Presence of *B. coli* and other intestinal bacteria associated with pollution.

#### CHEMICAL EXAMINATION.

Total Residue on Evaporation—Loss on Ignition—Fixed Solids—Alkalinity—Hardness—Incrustants—Chlorine—Iron—Nitrogen as Albuminoid Ammonia—Nitrogen as Free Ammonia—Nitrogen as Nitrites—Nitrogen as Nitrates—Total Organic Nitrogen (Kjeldahl Method)—Oxygen Consumed—Dissolved Oxygen—Free Carbonic Acid. (Some of these are of use only in special cases.)

\* Copies of this report may be obtained from the Secretary of the Association, 289 Fourth Ave., New York City.

Such an analysis is intended to show whether the water is of such a character that it would be liable to cause sickness if used for drinking; whether it contains anything that would render it distasteful or unpalatable; and whether it contains ingredients that would make it unfit for laundry use or for general domestic or industrial purposes. Analyses are necessary also, and perhaps have their chief use, in studying the effect of processes of purification of water and sewage.

Opinions regarding the function and value of sanitary water-analyses have undergone a change in recent years. The numerical results of a single analysis of a sample of water, when considered by themselves, are now believed to have little intrinsic value. It has been found that the value of the analysis lies in its interpretation, and that each part of the analysis must be interpreted by comparison with all the other parts and in the light of exact knowledge of the environment of the water. The interpretation of an analysis is as much a matter of expert skill as is the making of the analysis itself. The physical, biological, and chemical examinations should be interlocking in their testimony, yet these different parts are to be given different weight in the study of different problems. For example, in the detection of pollution the chemical and bacterial examinations furnish the most information, in the study of the æsthetic qualities of a water the physical and microscopical examinations are most important, while in investigations concerning the value of a water for industrial purposes the chemical and physical examinations may alone suffice.

The biological examination is concerned with the micro-organisms found in water. The term "micro-organisms," when used in its broadest and most literal significance, includes all organisms which are invisible or barely visible to the naked eye. It is frequently used in a narrower sense, however, as a synonym for bacteria. Using the word in its broad sense we may divide the micro-organisms found in water into two classes, as suggested by Professor Sedgwick.

<p style="text-align: center;">MICRO-ORGANISMS.</p> <p>Organisms, either plants or animals, invisible or barely visible to the naked eye.</p>	}	<p style="text-align: center;"><i>Microscopic Organisms. (Plankton.)</i></p> <p>Not requiring special culture. Easily studied with the microscope. Microscopic in size, or slightly larger. Plants or animals.</p> <p style="text-align: center;"><i>Bacterial Organisms.*</i></p> <p>Requiring special cultures. Difficultly studied with the microscope. Microscopic or sub-microscopic in size. Plants.</p>
---	---	--

This subdivision is convenient for the sanitarian as well as for the biologist, because the two classes of organisms affect water in different ways. With certain reservations it may be said that bacteria make a water unsafe, microscopic organisms make it unsavory.

**Microscopical Examination.**—The microscopical examination of water may be considered in five aspects: 1. As indicating sewage contamination. 2. As indicating the progress of the self-purification of streams. 3. As explaining the chemical analysis. 4. As explaining the cause of turbidity, odors, etc., in water. 5. As a means of identifying the source of a water (in special cases). 6. As a method of studying the food of fishes, oysters and other aquatic organisms.

**Sewage Pollution.**—The microscopical examination cannot be depended upon to determine the pathogenic qualities of a drinking water. To be sure, the germs of disease are microscopic bodies, and when artificially cultivated or when found in the tissues of the body can be studied with microscopes of high power; but when scattered through a mass of water they cannot be detected by ordinary microscopical methods, on account of their small size and because they are greatly outnumbered by the ordinary water bacteria. It is not easy to discover them even by methods of culture. Not only may water contain pathogenic bacteria without discovery, but it may contain the ova or larvæ of some of the endoparasites of man. It is probable

\* The bacteria are not considered in this volume. The reader is referred to the numerous works on Bacteriology, and especially to Prescott and Winslow's "Elements of Water Bacteriology."

that endoparasitic diseases are more common than has been generally supposed; and while diseased pork, beef, etc., are the chief agencies of infection, it is known that water polluted by animal excrement may contain the ova or larvæ of such endoparasites as *Tænia solium*, *Tænia saginata*, *Botrioccephalus platus*, *Ascaris lumbricoides*, *Trichocephalus dispar*, and *Anchylostomum duodenale*. Infection of animals by the drinking of water contaminated by barnyard wastes has been several times recorded, while a microscopical examination of the water has seldom revealed the presence of the suspected ova or larvæ. This is not because they are too minute to be detected, but because the quantity of water examined is necessarily too small.

The microscopical examination cannot show definitely whether a water is polluted by sewage unless the pollution is excessive. It can, however, give evidence which, taken with the chemical and bacterial examinations, may establish the proof. A microscopical examination of sewage reveals few of the living organisms that are found ordinarily in water. Ciliated infusoria, such as *Paramæcium* and *Trachelocerca*; fungus forms, such as mold hyphæ, *Saprolegnia*, *Leptomitus*, *Leptothrix*, and *Beggiatoa*; and miscellaneous objects, such as yeast-cells, starch-grains, fibres of wood and paper, fibres of muscle, epithelial cells, threads of silk, woolen, cotton and linen, insect scales, feather barbs, etc., may be observed. Most of these objects are foreign to unpolluted water, and their presence in a sample of water leads one to suspect its purity.

Furthermore, there are other organisms, such as *Euglena viridis*, which live on decaying vegetable matter and which, though not found in sewage, are often associated with it in polluted water. Their presence in a sample is a cause of suspicion. These evidences, however, should be weighed only in connection with an environmental study and with the entire sanitary analysis. The common microscopic organisms found in water are not themselves the cause of disease, nor does their presence indicate sewage pollution.

**Self-purification of Streams.**—The progress of the self-purification of streams may also be studied by noting the changes

in the character of the microscopic organisms. That a proper balance must be maintained between different groups of organisms in order that condition of foulness may not follow seems to be one of the results of recent investigations.

**Interpretation of Chemical Analysis.**—The chemical examination determines the amount of organic matter that a sample of water contains, but it does not determine the nature of it. As the character and condition of the organic matter are very important from the sanitary point of view, the microscopical examination gives valuable information by showing not only whether the organic matter in suspension is vegetable or animal, but by determining whether it is made up of living organisms or of decomposing fragments. For example, the amount of albuminoid ammonia in suspension is sometimes so great that one might suspect that the water was polluted did the microscope not show that the high figure was due to a growth of some organism; or in a series of samples from a reservoir it might be difficult to account for a sudden decrease in the nitrates or free ammonia were it not for the appearance of some microscopic organism that had appropriated the nitrogen as a part of its food.

**Cause of Odors.**—Perhaps the most important service that the microscopical examination renders is that of explaining the cause of the taste and odor of a water and of its color, turbidity, and sediment. Several of the common microscopic organisms give rise to objectionable odors in water and, when sufficiently abundant, have a marked influence on its color. They also make the water turbid and cause unsightly scums and sediments to form. Upon all such matters related to the æsthetic qualities of a water the microscopical examination is almost the only means of obtaining reliable information.

**Origin of Waters.**—The presence of certain microscopic organisms in water sometimes gives a clue to its origin. In this way the presence of surface-water in a well may be detected. In the Chicago Drainage Canal case the presence of Lake Michigan water in the St. Louis water-supply was indicated by finding in it a certain diatom characteristic of the Lake Michigan water.

**Food Supply of Fish Life.**—The microscopic organisms form the basis of the food-supply of fish and other aquatic animals. Sometimes the relation is a direct one; that is, the microscopic organisms are themselves eaten by fish. This was well illustrated by Peck in his study of the menhaden. This fish when feeding swims with its mouth open. The water enters the mouth and passes out through the gills which act as a filtering apparatus by which the minute organisms are caught. It was found that the presence or absence of these fish from certain sections of the Massachusetts coast depended upon the abundance of microscopic life in the water, and also that the weight of fish of any particular length depended upon the quantity of this food material at hand. Forbes has summed up the relation by saying, "No plankton, no fish."

The relationship between the plankton and fish life is not always so direct. In many cases the fish feed upon crustacea and insect larvæ; the crustacea feed upon the rotifera and protozoa; the rotifera and protozoa feed upon algæ and bacteria; while the algæ nourish themselves by the absorption of soluble inorganic substances and gases provided in part by the decomposition of animal and vegetable matter brought about by bacteria.

Oysters feed largely upon diatoms, and the Sedgwick-Rafter method has proved very useful in the study of this problem in the Great South Bay, Long Island, and elsewhere.

**Ecology.**—The interrelations between different organisms of the lower world, and between the organisms and their environment are matters of intense scientific interest, and limnology and microscopical ecology are fast assuming important places in scientific literature. The physical condition of lakes, the currents, waves, temperature, and transparency of water, the chemistry of water, the life-history of organisms, and various bio-chemical and bio-physical problems are more and more attracting the attention of scientists and of water-works engineers.

## CHAPTER III

### COLLECTION OF SAMPLES

It cannot be too strongly emphasized that samples of water for analysis must be collected with great care. Whenever possible the analyst himself should supervise the collection. If he attempts to draw inferences from analyses of samples of water about the collection of which he knows nothing he does so at the risk of his reputation.

The quantity of water required for a microscopical examination depends upon the nature of the water. Usually one quart is sufficient, but a gallon is to be preferred and this amount is necessary when a chemical analysis also is to be made. Glass-stoppered bottles should be used, and they should be scrupulously clean. When sent by express they should be packed in covered boxes that have compartments lined with suitable packing-paper to prevent breaking. In winter it may be necessary to use a felt lining to prevent freezing.

**Sample Collecting.**—In collecting a sample of water from a service-tap the water should be allowed to run for several minutes before the bottle is filled and the bottle should be rinsed several times before the final filling. The bottle should not be filled completely, but a small air-space should be left for expansion. If the sample be from a stream care must be taken not to stir up the deposit on the bottom, or to allow floating masses of vegetable matter to enter the bottle. This may be sometimes prevented by pointing the mouth of the bottle down stream. In collecting a sample from a pond good judgment must be used in securing a representative sample. The bottle should be filled in such a way that the surface-scum may not enter. When collecting samples from streams or lakes the nature of the littoral

growths in the vicinity should be noted. These notes are sometimes of value in the interpretation of an analysis.

**Deep Sample Collector.**—Numerous methods have been suggested for collecting samples from depths below the surface. The simplest method consists of lowering a weighted stoppered bottle to the desired depth and pulling out the stopper by means of a separate cord. When the bottle is full it may be drawn to the surface with little probability that the water will be displaced. An extra precaution to avoid admixture with the upper layers of water may be taken by using a rubber stopper fitted with a glass tube bent at right angles above the stopper and sealed at the end. With this arrangement the water is allowed to enter the bottle by breaking the glass tube by a pull from an auxiliary cord, or an inflated rubber ball may be put into the bottle. When the water enters, the ball will be forced up into the neck of the bottle on the inside and make an effective seal.

**Steuer's Rig.**—Steuer, in his *Planktonkunde* has described a convenient method of lashing a bottle and weight to the end of a rope. This rig is shown in Figs. 2 and 3.

**Whipple's Collecting Device.**—When collecting samples from depths greater than 50 ft. it is desirable to avoid the use of the auxiliary cord. The following apparatus has proved very satisfactory down to depths of 400 ft. (See Fig. 1.)

The frame for holding the bottle consists of a brass wire, *A*, attached to a weight, *B*, which is made by rolling a sheet of brass so as to form the sides of a shallow pan and filling this with melted lead to the height indicated by the dotted line. At each side where the wire rod is attached a strip of brass

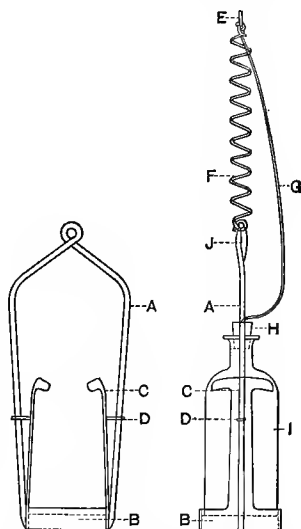

FIG. 1.—Apparatus for Collecting Samples of Water.  
After Whipple.

extends upward, terminating in a clip, *C*. These brass strips have considerable spring and are designed to hold the bottle in place, as shown in the cut. Guides, *D*, prevent the strips from being bent too far inward, and the uprights, *A*, prevent

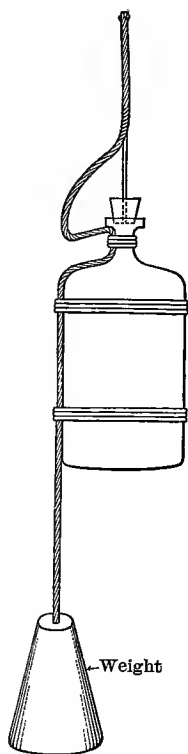

FIG. 2.—Rig for Binding Bottle to Rope and for Drawing the Stopper.

After Steuer.

them from being bent too far outward. The bottle may be inserted easily by holding back the springs, *C*, and pushing it between the clips. The frame is supported by the spring, *F*, joined to the sinking-rope, *E*. A flexible cord, *G*, extends from the top of the spring, *E*, to the stopper, *H*, of the bottle, *I*. The length of this cord and the length and stiffness of the spring are so adjusted that when the apparatus is suspended in the water by the sinking-rope the cord will be just a little slack. In this condition it is lowered to the depth at which one wishes to fill the bottle. A sudden jerk given to the rope stretches the spring and produces sufficient tension on the cord, *G*, to pull out the stopper. As a precaution against a possible loss of the apparatus through breaking of the spring, a safety-cord, not shown in the figure, extends through the helix connecting the sinking-rope, *E*, directly to the frame, *J*. This safety-cord, which is always somewhat slack, is also adjusted to prevent too great a stretching of the spring.

With great depths it is necessary to reduce the size of the aperture through which the water enters the bottle and to close this with a suitable valve. This may be done by passing a piece of brass tube through a rubber stopper and closing this tube at the top with a brass plug ground to fit; or the spring may be used to break the end of a sealed glass tube inserted in the stopper. A still better

method is that devised by Mr. Richard H. Eurich, while a student of sanitary engineering in Harvard University.

**Eurich's Stopper for Water Sampling Bottle.** In order to obviate the trouble experienced in drawing the stopper of a bottle against heavy pressure, when collecting a sample of water from a considerable depth, a balanced valve is used for admitting the water to the bottle.

The valve, or stopper, shown in Fig. 4 is constructed of brass or other suitable non-corroding metal. It is in two pieces, an inner one, *A*, and an outer one, *B*. The lower part of *A* is ground to fit into the neck of the bottle, and the upper part contains the ports through which the water enters. The outer piece is a cylindrical shell which slips down easily over the inner piece, just closing the ports. The releasing line is attached to the outer piece, so that when the line is jerked the piece is pulled off, allowing the water to enter the bottle through the ports. The apparatus is hauled to the surface without any attempt at closing the ports, experience having shown that the entrance of water on the way up is negligible.

**Strainer Jars.**—For collecting material for qualitative examination strainer jars are useful. They may be made in several ways. A convenient arrangement is that shown in Fig. 7. Bolting-cloth makes the best strainer, but muslin or a linen handkerchief will serve.

**Plankton Net Method.**—The plankton net originally designed by Hensen, consists of a conical net of silk bolting-cloth suspended from an iron ring and terminating at the lower end in a flat metal ring to which is attached the filtering-bucket. The latter consists of a metal frame covered on the sides with bolting-cloth, and having a slightly conical bottom. In the middle of the bottom there is an outlet-tube closed with a removable plug. The bucket is about  $2\frac{1}{2}$  inches in diameter. It is sup-

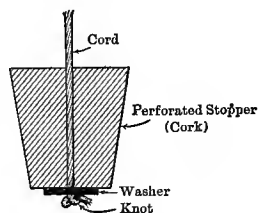

FIG. 3.—Method of Attaching Stopper to Cord. After Steuer.

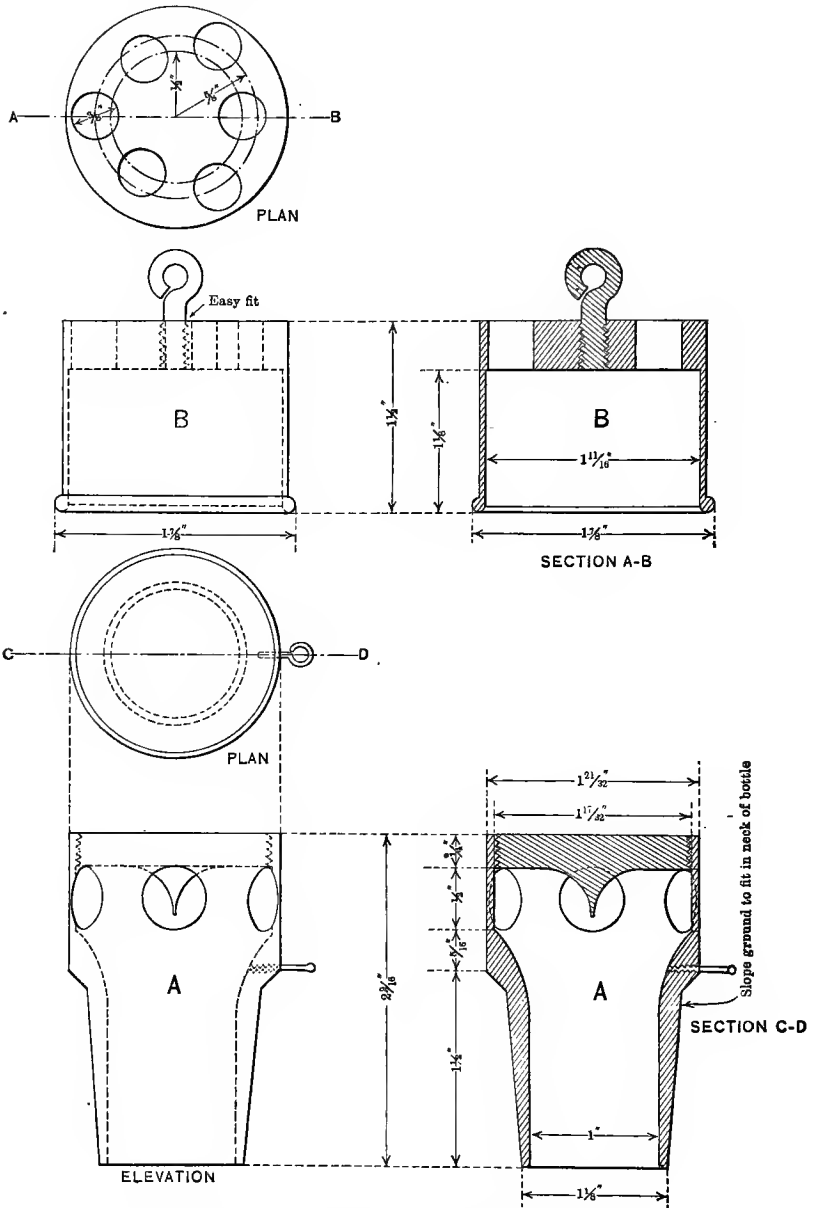

FIG. 4.—Eurich's Stopper for Water Sampling Bottle.

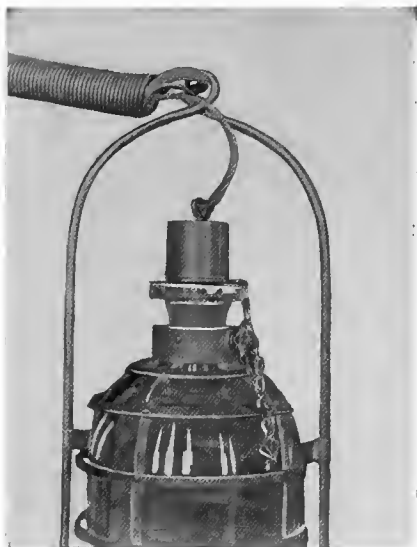

FIG. 5.—Collecting Bottle Showing Stopper with Upper Part in Place. After Eurich.



FIG. 6.—Collecting Bottle Showing Stopper with Upper Part Off. After Eurich.

ported on three legs when detached from the net. The filtering-net of bolting-cloth is protected by a twine net which helps to bear the strain when the net is drawn through the water. Cords extend from the iron ring to the bucket in order to further relieve the filtering-net from strain. Above the filtering-net there is a truncated canvas cone that serves as a guard, preventing the entrance of mud when near the bottom and preventing the contents of the net from spilling over the edge. It is this diameter that determines the volume of water filtered

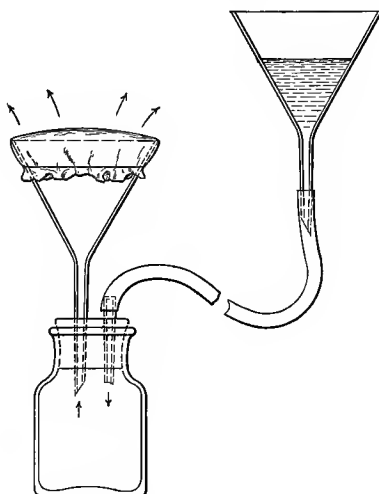

FIG. 7.—Apparatus for Concentrating Microscopic Organisms.

when the net is drawn through the water. The whole net is suspended by three cords attached to radiating iron arms fastened to the rope by which the apparatus is raised and lowered.

The nets are made of various dimensions. Reighard's net, used in Lake St. Clair was 3 ft. in length, 2 ft. in maximum diameter, with an opening 16 inches in diameter. Birge has used a smaller net and for water-supply investigations the author prefers this to the larger form.

**Operation of Plankton Net.**—The plankton net is operated as follows: It is lowered to the bottom or to the desired depth

and then drawn to the surface, the velocity of its ascent being noted. On the way down it takes in no water except what is filtered through the gauze. On the way up it filters a column of water the cross-section of which is that of the opening of the guard net and the height of which is equal to the distance through

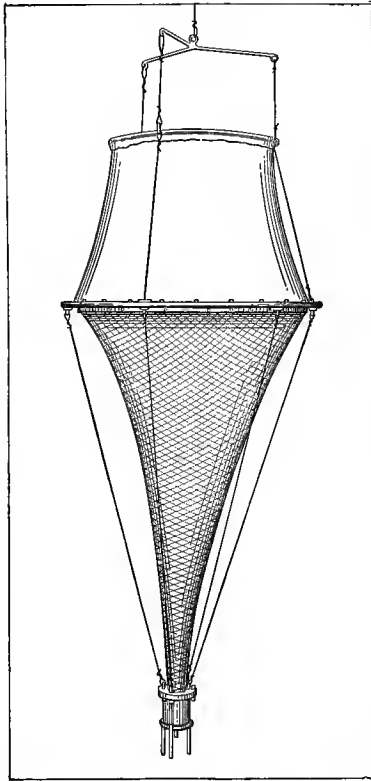

FIG. 8.—Plankton Net. After Reighard.

which the net was drawn. This is the theoretical amount filtered. Actually the net does not strain the whole column of water through which it passes, as a portion of the water is forced aside. Therefore in order to obtain the volume of plankton in the column traversed it is necessary to multiply the observed result by a factor or coefficient. This net-coefficient

varies for each net and for different velocities of ascent through the water. It also varies with the amount of clogging. With velocities of 2 to 3 ft. per second the coefficient is about 2.5. It is necessary to know the coefficient for each net at different velocities and to correct the results of each haul for the particular velocity used. Evidently the results obtained are not of great accuracy.

When the net reaches the surface it is allowed to drain. A stream of water played on the outside of the net detaches the organisms from the bolting-cloth and washes them down into the bucket. The bucket is then detached from the net and its collected material is transferred to a small bottle for transportation to the laboratory.

A plankton net once used by Birge differs from the one just described in that it has a cover instead of a guard-net. The cover slides in a rectangular frame. It is moved by delicately adjusted weights set in action by a releasing device which is operated by messengers sent down the rope. The cover may be opened or closed at any depth at the will of the operator. This enables one to collect material from the lower strata without having it contaminated with that above it.

**Quantitative Estimation of the Plankton.**—The amount of plankton collected may be determined by four methods: (1) by estimation of the volume; (2) by determination of the weight; (3) by chemical analysis; (4) by enumeration of the organisms.

The volume is obtained by allowing the material to stand in alcohol in a graduated cylinder for 24 hours. At the end of that time the plankton will have settled and the volume in cubic centimeters may be read from the scale. This gives the total volume in one catch. It is customary to express results in "number of cubic centimeters of plankton under one square meter of surface" or in "number of cubic centimeters of plankton in one cubic meter of water."

The approximate weight may be determined by drying on filter-paper and weighing. The results are usually expressed in grams of plankton under one square meter of surface or in one cubic meter of water.

The chemical analysis of the plankton usually consists of the determination of the percentage of organic material, ash, silica, etc.

The enumeration of the organisms is the most important part of the laboratory investigation. The material is evenly distributed in a definite amount of alcohol by shaking, and a portion is removed to a small trough or cell and placed under the microscope. The various organisms are then counted. Lines drawn on the bottom of the cell aid the observer in covering the entire area of the cell. As in the case of volume and weight, the results are generally expressed either in "number of organisms under one square meter of surface" or in "number of organisms per cubic meter of water." Both these methods are objectionable because so many figures are involved. They often extend to the millions and sometimes to the billions. It is preferable to express the smaller organisms, such as the algæ and protozoa, in "number per cubic centimeter," and the larger organisms, such as the crustacea, rotifera, etc., in "number per liter."

It is evident that the "plankton net method" involves many sources of error. Neither the amount of water strained nor the completeness of the filtration can be definitely ascertained. The loss of the smaller organisms by leakage through the meshes of the silk is very great, and many of the delicate organisms are crushed upon the net. The methods of estimating the volume and weight of the plankton, moreover, are exceedingly inaccurate. The method of enumerating the organisms is much to be preferred. Except in the case of comparatively large organisms, such as the Rotifera, Crustacea, etc., the results of the net method cannot be depended upon within 50 per cent.

In spite of these inaccuracies, however, the plankton net is deserving of greater use by those interested in the biology of water-supplies. It is a valuable adjunct to the Sedgwick-Rafter method, which because it is applied to small samples is liable to miss the presence of important organisms at depths different from those at which the samples were collected.

**Plankton Pump.**—The plankton pump is designed to collect the plankton from any particular depth in a lake. It consists of a sort of force-pump so arranged that a definite and measurable quantity of water is delivered at each stroke; an adjustable hose through which the water is drawn from the desired depth; and a filtering-bucket into which the water is pumped. The straining is effected by allowing the water to pass through a cylinder of fine wire gauze at the lower end of the filtering-

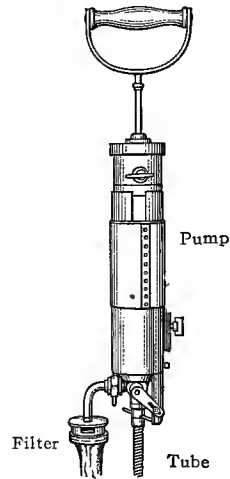

FIG. 9.—Plankton Pump. After Wilhelmi.

bucket. The efficiency of the strainer is increased by covering the wire gauze with fine bolting-cloth.

This method has the advantage of measuring the quantity of water strained with greater accuracy than is possible in the net method, but the error from imperfect filtration is large.

The method is easily applied and is susceptible of a greater accuracy than has usually been obtained. A bicycle pump, with valves changed so as to produce suction, may be used instead of a force-pump. Fig. 9 shows the arrangement of a plankton pump.

This improved form of plankton pump is described by

Dr. Julius Wilhelmi in Mitteilungen aus der Königlichen Landesanstalt für Wasserhygiene, Vol. 17, p. 126.

**Preservation of Microscopic Organisms.** For the technique of killing and preserving microscopic organisms the reader is referred to works on histology, and microscopical technique. The following are a few of the solutions that will be found useful.

The microscopic organisms may be preserved in permanent mounts upon glass slips but for practical study it is more convenient to preserve them in mass in 2-oz. bottles. For this purpose the following killing and preservative fluids may be found useful:

*King's Fluid* (for preserving algæ, etc.).—

Camphor-water *	.....	50	grams.
Distilled water	.....	50	“
Glacial acetic acid	.....	0.50	“
Copper nitrate, crystals	.....	0.20	“
Copper chloride, crystals	.....	0.20	“

*Corrosive Acetic Acid* (for killing).—Saturated solution of mercuric chloride plus 10 per cent of acetic acid. After using, wash with water. Preserve in alcohol.

*Formaldehyde*.—For killing, use a 40 per cent solution, sold under the name of “Formalin.” For preserving, use solutions varying from 5 to 10 per cent, according to the organisms.

*Picro-sulphuric Acid* (for killing).—

Distilled water saturated with picric acid	. . .	100	c.c.
Sulphuric acid, strong	.....	.2	c.c.

After using, wash with 60 per cent alcohol.

*Corrosive Sublimate* (for killing Protozoa).—To water containing the organisms add an equal volume of saturated corrosive sublimate. Decant, and add 50 per cent alcohol, changing this in an hour to 70 per cent.

\* Made by letting a lump of camphor stand in distilled water for a few days.

**Collection of Samples for the Determination of Dissolved Oxygen.**—Many devices have been used for collecting samples of water for the determination of dissolved oxygen. The one shown in Fig. 10, has proved very satisfactory.

The small "dissolved oxygen" bottle *b* is clamped to the side of the cage which holds the large bottle and is connected

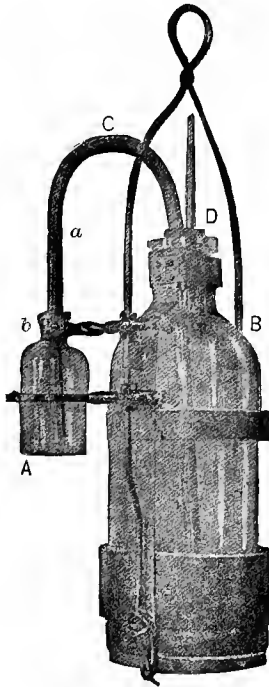

FIG. 10.—Bottle for Collection of Dissolved Oxygen Samples.

with the large bottle *B* by the metal tube *C* which leads from near the top of *b* to near the bottom of *B*. The upper end of a small tube *A*, inside of *C*, communicates freely with the outside water at *a*, and its lower end terminates near the bottom of *b*. A straight tube *D* leads from the upper part of *B* up to the outside water.

With both bottles *B* and *b* empty and the rubber stoppers through which the tubes are inserted firmly in place, the apparatus is lowered rapidly to the desired depth. The action then taking place is as follows: The air in *B* escapes through *D* and draws the water in at *a*, filling *b* and then drawing water over through *C* into *B*. Thus a flow is set up through the small bottle with the result that finally a sample is left in it which has not come in contact with any air, and which, consequently is a proper sample from which to determine the dissolved oxygen in the water. The relative sizes of the two bottles determine the volume of water flowing through the small bottle. In the apparatus here described the small bottle held about 300 c.c.

## CHAPTER IV

### METHODS OF MICROSCOPICAL EXAMINATION

THE best method of determining quantitatively the abundance of microscopic life in water is the Sedgwick-Rafter method, to be described in the present chapter. The plankton net is used largely by those who are most interested in the rotifers, crustacea and the larger forms of organisms. The plankton pump and the planktonokrit, described later, are but little used, although they are capable of development.

**The Sedgwick-Rafter Method.**—The Sedgwick-Rafter method consists of the following processes: the filtration of a measured quantity of the sample through a layer of sand upon which the organisms are detained; the separation of the organisms from the sand by washing with a small measured quantity of filtered, or distilled, water and decanting; the microscopical examination of a portion of the decanted fluid; the enumeration of the organisms found therein; and the calculation from this of the number of organisms in the sample of water examined. The essential parts of the apparatus are the filter, the decantation-tubes, the cell, and the microscope with an ocular micrometer.

**Filtration.**—The sand may be supported upon a plug of rolled wire gauze at the bottom of an ordinary glass funnel 7 or 8 inches in diameter, but the cylindrical funnel shown in Fig. 11 is preferable. The inside diameter of this funnel at the top is 2 inches; the distance from the top to the beginning of the slope is 9 inches; the length of the slope is about 3 inches; the length of the tube of small bore is  $2\frac{1}{2}$  inches, and its inside diameter is  $\frac{1}{2}$  inch. The capacity of the funnel is 500 c.c. The support for the sand consists of a perforated rubber stopper pressed tightly into the stem of the funnel and capped with a

circle of fine silk bolting-cloth. The circles of bolting-cloth may be cut out with a wad-cutter. Their diameter should be a little less than that of the small end of the rubber stopper. When moist the cloth readily adheres to the stopper. The sand resting upon the platform thus prepared should have a depth of at least three-fourths of an inch. The quality of the sand is important but no very definite degree of fineness need be sought. Ordinary sand is unsatisfactory unless very thoroughly washed. Pure ground quartz is preferable. Its whiteness is a decided advantage. The necessary degree of fineness of the sand depends somewhat upon the character of the water to be filtered. A sand which will pass through a sieve having 60 meshes to an inch, but which will be retained by a sieve having 120 meshes, will be found satisfactory for most samples. Such a sand is described as a 60-120 sand. When very minute organisms are present a finer sand must be used—say a 60-140 sand. The sand used for many years by the author had an effective size of 0.15 mm.

The filter may be supported on a ring stand. If many are required they may be arranged conveniently in a row against the laboratory wall as shown in Fig. 12, or on a revolving circular frame as in Fig. 13. The filtered water may be collected in a sloping trough and carried to a sink, or jars may be placed under the separate funnels. A hinged covering-shelf above the filters is useful to prevent the access of dust.

The sample to be filtered may be measured in a graduated cylinder or flask, or the filter-funnel itself may be graduated. The graduated filter-funnel is especially useful for field work,

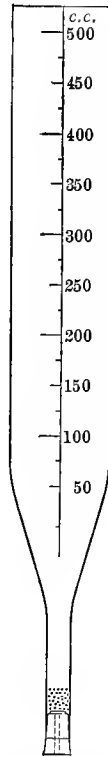

FIG. 11.—Graduated Cylindrical Funnel Used in the Sedgwick-Rafter Method.

as it saves the necessity of carrying an additional graduate. The quantity of water that should be filtered depends upon the number of organisms and the amount of amorphous matter present. An inspection of the sample will enable one to judge the proper amount. Ordinarily 1000 c.c. for a ground-water and 500 c.c. for a surface-water will be found satisfactory. In some cases 250 c.c. or even 100 c.c. of a surface-water will be

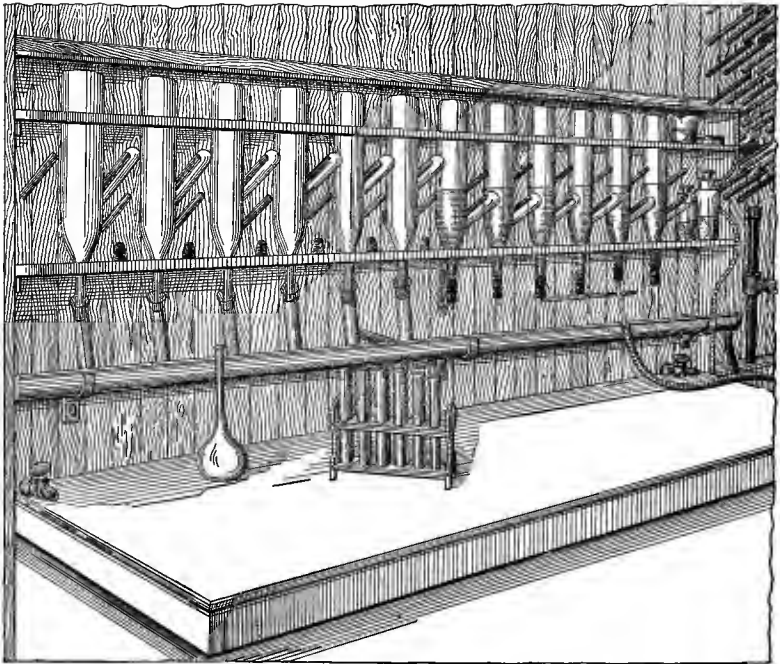

FIG. 12.—Battery of Filters. Sedgwick-Rafter Method.

found more convenient. When the water is poured into the funnel care should be taken not to disturb the sand more than is necessary, otherwise organisms are liable to be forced through the filter. The best way is to make the sand compact by pouring in enough distilled water to just about fill the neck of the funnel, pouring in the measured sample before the sand has become uncovered. The collection of air in the sand may be prevented by first putting in a small portion of

the sand, and adding a small amount of distilled water into which the rest of the sand is allowed to fall. The filtration ordinarily takes place in about half an hour, but occasionally a sample is so rich in organisms and amorphous matter that the filter becomes clogged. It then becomes necessary to agitate the sand with a glass rod or to apply a suction to hasten the

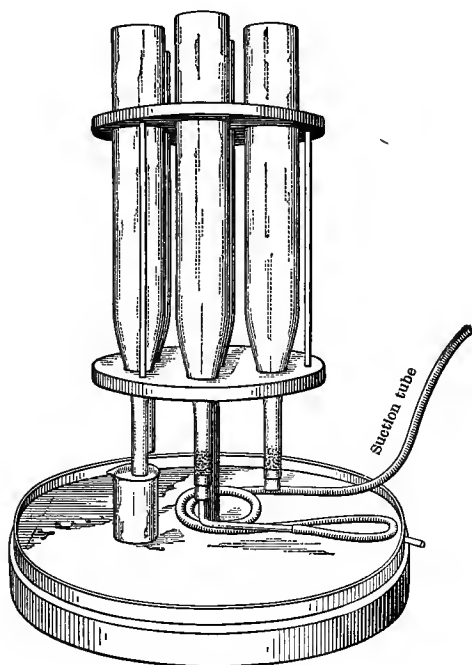

FIG. 13.—Revolving Stand for Supporting Filter Funnels. After Bunker.

filtration. If the filters are located near running water an aspirator may be attached to the faucet and connected with the filter by a rubber tube having a glass connection that fits the bore of the rubber stopper. The use of the aspirator enables the filtration to be made in a few minutes, and not only effects a saving in time, but reduces the error caused by the organisms settling on the sloping surface of the funnel.

**The Sling Filter.**—For using the Sedgwick-Rafter method in the field the sling filter has been found serviceable. This is made of metal instead of glass. Filtration is hastened by swinging the funnel around an axis, thus making it virtually a centrifugal machine. The construction of the sling filter is shown in Fig. 14.

**Concentration.**—As a result of the filtration the organisms and whatever other suspended matter the sample contained will have been collected on the sand. When all the water has passed through and before the sand has become dry the rubber stopper is removed and the sand with its accumulated organisms is washed down into a wide test-tube by a measured quantity of filtered or distilled water delivered from a pipette. The amount of water used for washing depends upon the number of organisms collected on the sand. If 500 c.c. of the sample is filtered it is usually best to wash the sand with 5 c.c. thus concentrating the organisms one hundred times. The amount of water filtered divided by the amount of water used in washing the sand gives the "degree of concentration." The degree of concentration may vary from 10 to 500 according to the contents of the sample. Ordinarily it should be 50 or 100.

By shaking the test-tube the organisms will become detached from the sand-grains. If this is followed by a rapid decantation into a second test-tube most of the organisms, being lighter than the sand, will pass over with the decanted fluid, while the sand is left upon the walls of the first tube. To insure accuracy the sand should be washed a second time and the two decanted portions mixed together. If, for example, it is desired to concentrate a sample from 500 c.c. to 10 c.c. the sand should be washed twice with 5 c.c. and the two portions poured together. This will give a more accurate result than a single washing with 10 c.c.

To prevent fragile organisms from disintegrating on the sand surface after filtration, when the sand tends to become dry, an attachment may be used as shown in Fig. 15. The glass tube, bent twice at right angles and inserted in the rubber stopper, checks filtration when the level of the water in the funnel

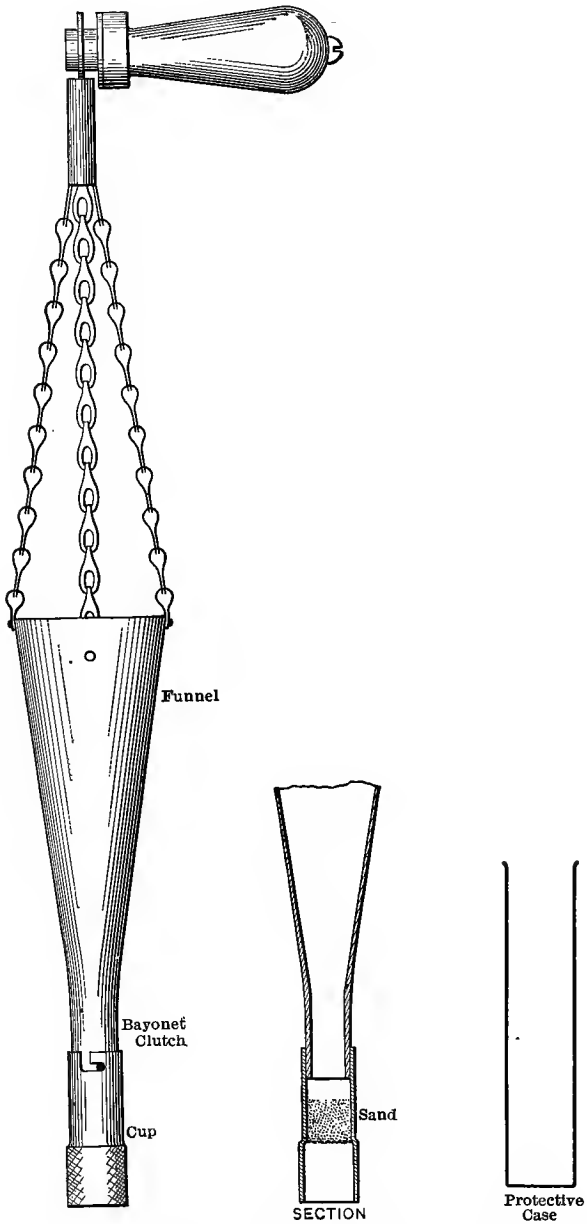

FIG. 14.—The Sling Filter for Use with the Sedgwick-Rafter Method in the Field.

has fallen to that of the open arm of the tube. If the operator is watching the filtration even this form of attachment is unnecessary, as the filtration may be stopped by inserting a plug in the rubber stopper as soon as the level of the water has fallen to the desired point. If fragile organisms are present this method of concentrating is to be preferred to the usual one described above in which the surface of the sand is allowed to become uncovered before the sand is washed into the test-tube. As the use of either form of attachment described above retards the rate of filtration it is better not to put on the attachment until the water has fallen almost to the desired level.

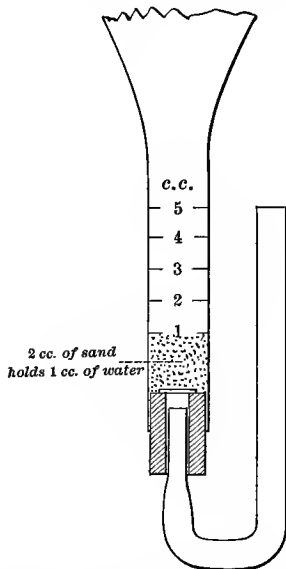

FIG. 15.—Concentrating Attachment.

If the concentrated water is allowed to stand in the funnel for any length of time some of the organisms are liable to become attached to the glass sides. To prevent error from this cause the neck of the funnel may be washed with a small measured quantity of filtered water, and this may be caught in the large test-tube and used for washing the sand a second time as described above. This procedure is seldom necessary.

**The Cell.**—The cell into which a measured portion of the concentrated fluid is placed for examination is made by cementing a brass rim to an ordinary glass slip. The cell originally used was rectangular. Its internal dimensions were length 50 mm., width 20 mm., and depth 1 mm. It therefore has an area of 1000 sq. mm. and a capacity of 1 c.c. A thick cover-glass (No. 3) having dimensions equal to those of the outside of the brass rim (55 mm. by 25 mm.) forms a roof to the cell. The concentrated organisms in the decantation-tube are distributed uniformly through the fluid by blowing into it through a

pipette, and the cell is then filled with the fluid in such a manner as to distribute the organisms evenly over the entire area. This may be done by laying the cover-glass diagonally over the cell so that an opening is left at either end, and flowing the

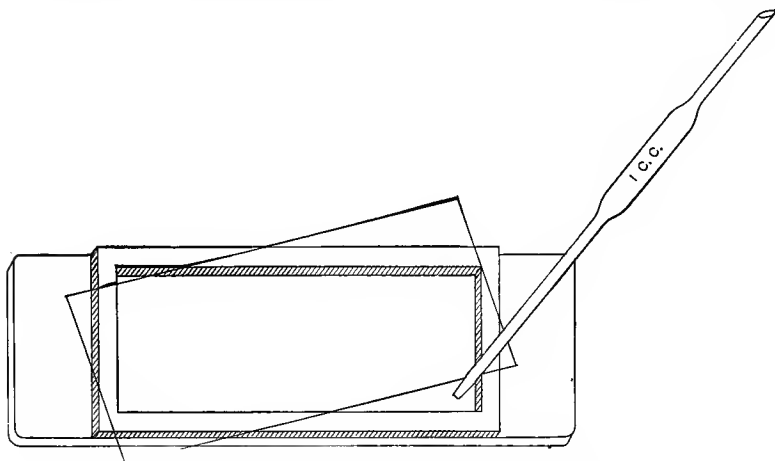

FIG. 16.—Counting Cell, Showing Method of Filling.

water in at one end while the air escapes at the other (see Fig. 16).

It is not necessary to use a rectangular cell. A circular cell is equally satisfactory, is much cheaper and is easier cleaned. The capacity of the cell is immaterial, but a volume of about one cubic centimeter is most convenient. It is necessary, however, that the depth be exactly one millimeter. The circular cell is shown in Fig. 17.

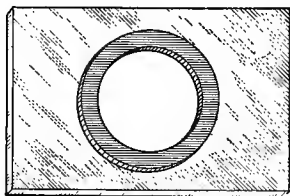

FIG. 17.—New Form of Counting Cell. After Bunker.

**The Microscope.**—An expensive microscope is not needed for the numerical estimation of the common microscopic organisms found in water. A simple, compact stand with a  $\frac{1}{2}$ -inch objective and a  $10\times$  ocular is sufficient. For studying the

organisms in detail and for general laboratory use in the study of water a large stand, with substage condenser, iris diaphragm, mechanical stage, etc., should be provided. The list of objectives should include a 2-inch, a  $\frac{2}{3}$ -inch, a  $\frac{1}{4}$ - or  $\frac{1}{6}$ -inch, and a  $\frac{1}{8}$ -inch homogeneous immersion, or their equivalents, and there should be several oculars magnifying from 4 to 12 times.

The use of the microscope is described at greater length in Chapter V.

**Ocular Micrometer.**—The ocular micrometer is an essential feature of the Sedgwick-Rafter method. It consists of a square

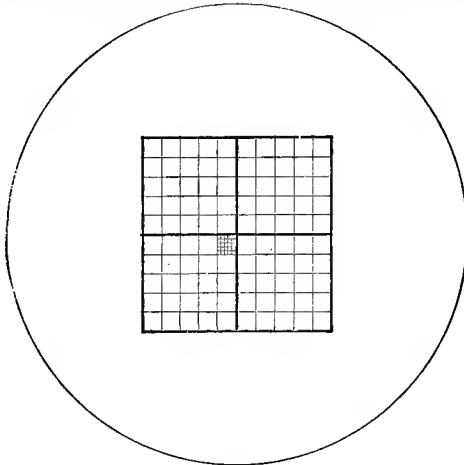

FIG. 18.

ruled upon a thin glass disk which is placed upon the diaphragm of the ocular. The square is of such a size that with a certain combination of objective and ocular and with a certain tube-length of the microscope, the area covered by it on the stage is just one square millimeter. Hence with a cell one millimeter thick, the volume within the outlines of the ruled square will be one cubic millimeter. For convenience it should be subdivided as shown in Fig. 18. The size of the largest square is one square millimeter. The size of the smallest square is one standard unit. The best micrometers are made by engraving, but a serviceable micrometer for occasional use may be made

by photography.\* With a  $\frac{1}{2}$ -inch objective and a No. 3 ocular the square ruled for the ocular micrometer should be 7 mm. on a side. Before using the micrometer the proper tube-length must be determined by trial using a stage micrometer for comparison.

**Enumeration.**—The cell, filled with the concentrated fluid, is placed upon the stage of the microscope and the organisms included within the area of the ruled square are counted. This, of course will give the number in one cubic millimeter of the concentrate. The cell is then moved so that another portion of the cell comes into the field of view and another square is counted. This is continued until a sufficient number of representative millimeter cubes has been examined. It is obviously impracticable to count all of the squares which compose the area of the cell. It is usually sufficient to count ten or twenty squares, but a larger number ought to be scrutinized. In counting it should be remembered that the cell is one millimeter deep and that some of the organisms are heavy and sink to the bottom, while others are light and rise to the top. The observer should make a practice of changing the focus of the microscope so that both the upper and lower portions of each cube may be examined.

From the number of organisms found in the ten or twenty squares or, more exactly cubes, it is an easy matter to calculate the number originally present in one cubic centimeter of the sample.

Let  $n$  = the number of squares counted, i.e., the number of cubic millimeters of the concentrate actually examined.

$t$  = the total number of organisms found in all of the squares counted.

$v$  = number of cubic centimeters of the sample filtered.

$c$  = number of cubic centimeters of water used in washing the sample.

\* This idea was suggested by Mr. Wallace Gould Levison, Brooklyn N. Y.

Then the number of organisms per c.c. ( $N$ ) will be represented by the formula

$$N = \frac{t}{n} \times \frac{1000 c}{v},$$

If, for example, 500 c.c. of water was filtered and 5 c.c. of water was used for washing the sample, and if 20 squares, i.e. 20 cubic millimeters, were counted

then 
$$N = \frac{t}{20} \times \frac{1000 \times 5}{500} = \frac{1}{2} t.$$

The number by which the total number of organisms counted must be multiplied in order to reduce the result to "number per c.c." is commonly called the multiplier.

It should be noted that this is independent of the area of the cell.

**Sources of Error.**—The operations of the Sedgwick-Rafter method involve several sources of error. They may be classified as follows:

1. Errors in sampling.
2. Funnel error, or the error caused by the organisms adhering to the sides of the funnel.
3. Sand error, or the error caused by imperfect filtration.
4. Error of disintegration, due to the breaking up of organisms on the surface of the sand.
5. Decantation error, or the error caused by the organisms adhering to the particles of sand, and by the water used in washing the sand being held back by capillarity during the process of decantation.
6. Errors caused by the organisms not being uniformly distributed in the cell.

**Errors in Sampling.**—These errors arise chiefly from the fact that organisms vary in specific gravity and in their behavior toward light. If the bottle containing the sample is allowed to stand even for a short time, some of the organisms will sink to the bottom, some will rise to the surface; some will

collect on the side of the bottle toward the light, others will shun the light as much as possible; while some will attach themselves quite firmly to the sides of the glass. Evidently the bottle must be shaken before the portion for examination is withdrawn. Errors in sampling are common, but, to a great extent, are avoidable.

**Funnel Error.**—The funnel error, due to the organisms settling upon and adhering to the sloping sides of the funnel, varies greatly according to the character of the water filtered. It is highest in the case of samples rich in the Cyanophyceæ and amorphous matter. These, being of a somewhat gelatinous nature, adhere readily to the glass, making a rough surface on which other organisms lodge. If the funnel is wet when the sand is put in, some of the sand-grains are liable to adhere to the sloping walls. This tends to increase the deposition of organisms. The funnel error is less in the cylindrical funnels than in the flaring funnels. Slow filtration, whether due to the character of the funnel or to the sample filtered, increases the error—indeed it may be said that the funnel error is almost proportional to the time of filtration. Numerically the funnel error may vary from 0 to 15 per cent. A long series of experiments with waters that varied greatly in character gave an average funnel error of 1 per cent for the organisms and 3 per cent for the amorphous matter.

**Sand Error.**—The sand error, due to imperfect filtration, depends upon the character of the organisms, upon the size of the sand-grains, and upon the depth of the sand. In selecting a sand two opposing conditions must be adjusted. The sand must be fine enough to form an efficient filter, and yet the grains must be large enough to settle readily in the decantation-tubes. A  $\frac{1}{2}$ -inch layer of the sand described on page 29 ought not to give a sand error greater than 5 per cent unless the water contains minute organisms. When very minute organisms are present in large numbers the error from incomplete filtration may be as great as 25 per cent or even 50 per cent. The effect of the size of the sand-grains on the sand error is well illustrated by the following table compiled from exper-

iments by Calkins on the filtration of water containing yeast-cells and starch-grains:

Size of Sand.	Percentage Sand Error.	
	Yeast-cells.	Starch-grains.
40-60	21.6	4.4
60-80	8.7	7.3
80-100	5.3	7.4
100-120	3.3	1.2

Most of the organisms that pass through the sand do so during the early part of the filtration, before the sand has become compacted. If, before the sample is poured into the funnel, the sand is compacted by passing through it some distilled water, using the aspirator to increase the pressure, the sand error will be reduced considerably.

**Errors of Disintegration.**—Many of the microscopic organisms are extremely delicate. They are very susceptible to changed conditions of temperature, pressure, and light. As soon as a sample of water has been collected in a bottle some of the organisms begin to disintegrate; and if the sample stands long before examination and if it is submitted to the joltings of a long trip by express, some of the organisms will break up and become unrecognizable. The process of filtration helps to disintegrate them by bringing them in violent contact with the surface of the sand, but the method of concentrating the sample by arresting the filtration as described above reduces this error to some extent by keeping the sand from becoming dry and by preventing many of the organisms from even reaching the surface of the sand. The errors due to disintegration during transit and before examination can be avoided only by making the examination at the time of collection. This is often necessary, particularly when one is searching for such delicate organisms as *Uroglena*. The errors of disintegration during filtration cannot be entirely avoided, but if the examination of the concentrated fluid is supplemented by a direct examination of the water gross mistakes may be prevented. *Uroglena*, *Dinobryon*,

and other forms may be detected in the sample with the naked eye after a little practice. They may be taken up with a pipette and transferred to the stage of the microscope for more definite identification. This direct examination is important and always ought to be made, but its value is qualitative and not quantitative.

**Decantation Error.**—The decantation error depends to a great extent upon care in manipulation. When the attempt is made to separate the organisms from the sand by agitating with distilled water in one test-tube and decanting into a second tube, some of the organisms remain behind attached to the sand-grains, and, what is quite as important, some of the water used in washing remains behind.

The two errors act in opposition. If the sand retains a larger percentage of organisms than of water, the figures in the result will be too low; if it retains a larger percentage of water than of organisms, the concentration will be too great and the figures in the result will be too high. With the fractional method of washing the sand and with due care in decanting the decantation error ought not to exceed 5 per cent.

**Errors in the Cell.**—The errors due to the unequal distribution of the organisms over the area of the cell are extremely variable and cannot be well stated in figures. If the concentrated fluid is evenly mixed and well distributed over the cell, if the count is made just as soon as the material in the cell has settled, and if a large number of squares are counted, the error will be reduced to a minimum. If a sample happens to contain such motile organisms as *Trachelomonas* or *Euglena* they may collect at the edges of the cell in search of air, or if the cell stands in front of a window for any length of time organisms sensitive to light may migrate from one side of the cell to the other.

**Precision of the Sedgwick-Rafter Method.**—Examination of hundreds of samples has shown that the results are usually *precise* within 10 per cent, i.e., two examinations of the same sample seldom differ by more than this amount. The accuracy, however, depends greatly upon the character of the organisms in the water examined. On account of the unavoidable errors

in this method care should be taken to avoid fictitious accuracy in tabulating the final results. No decimals or fractions should be used.

**Results of Examination.**—The microscopical examination of most samples of surface-water will show that the concentrated fluid contains minute organisms of various kinds, fragments of larger animals and plants, masses of a grayish or brownish flocculent material, and fine particles of inorganic matter. The inorganic or mineral matter is usually not considered in the Sedgwick-Rafter method; more information about it can be obtained by a direct examination of the sediment and by chemical analysis. The brownish flocculent material has been called “amorphous matter” because of its formless nature, and “zoöglœa” because of its supposed bacterial origin. The term zoöglœa has a definite meaning in bacteriology and is applied to a mass of bacteria held together by a more or less transparent glutinous substance. It is not strictly appropriate as applied to the brownish flocculent matter, which is not so much a collection of bacteria as the product of bacterial action. The word *phytoglœa* might be used in its place, but the term “amorphous matter” is a broader term and quite as appropriate. The amorphous matter, then, includes all the irregular masses of unidentifiable organic matter. It does not include vegetable fibers, vegetable tissue, etc., nor does it include mineral matter except as this is intimately mixed with the flocculent material.

**Standard Unit.** The amorphous matter occurs in a finely divided state or in lumps of varying size. In order to estimate correctly its amount it is necessary to have some unit of size. A unit of volume is impracticable because of the great labor involved in determining the dimensions of the masses observed, but a unit of area approaches closely to what is desired. Such a unit was suggested by the author in 1889, and has come into use under the name of “standard unit.” The standard unit is represented by the area of a square 20 microns\* on a side i.e. by 400 square microns.

\* One micron = .001 millimeter.

The ocular micrometer shown in Fig. 18 was subdivided to correspond to this unit. The large square, which covers one square millimeter on the stage of the microscope, is divided into four equal squares. Each of these quarters is subdivided into 25 smaller squares, and each of these squares contains 25 standard units. The eye will readily divide the side of a small square into fifths, and this division is the side of the standard unit square. If desired, one of the small squares may be further subdivided into squares the actual size of the standard unit as shown in the figure.

The microscopic organisms vary in size and in their mode of occurrence. Some are found as separate individuals, some are joined together into filaments, or into masses or colonies; some are one-celled, some are many-celled; some are extremely simple, some are complex; some are scarcely larger than the bacteria, some are easily visible to the naked eye. It is difficult to establish a satisfactory system for counting these varied forms. If an individual count is adopted one has to decide what shall be the unit, whether a cell, or a filament, or a colony, or a mass. Practice has varied in this matter. The best system of counting by individuals is that used by the Massachusetts State Board of Health. All diatoms, desmids, rhizopods, crustacea, the unicellular algæ, and nearly all rotifera and infusoria are counted as individuals; the filamentous algæ are counted as filaments; the social forms of infusoria and rotifera are counted as colonies; and many of the algæ that occur as irregular thalli are counted as masses.

This system, which, for convenience, we may call the "individual counting system," does not always give satisfactory results. In the Boston water-supply it was found often that a sample which a simple inspection showed to be heavily laden with algæ and which was offensive both in appearance and in odor gave a low figure in the count, while a sample that was clear and agreeable to the taste gave a very high figure. This was due largely to the great difference in the size of the organisms. A great mass of *Clathrocystis* was given no more weight in the result than a tiny *Cyclotella*. Each counted one, though

## MICROSCOPICAL EXAMINATION.

Sample of Croton Water, New York City.

Date of Collection, Aug. 25, 1897; Date of Examination, Aug, 25, 1897.

Concentration, 500 cc. to 10 cc. Multiplier, 2.

Number of Square.....	1	2	3	4	5	6	7	8	9	10	Total.	Number per c.c.	Average Size in Standard Units.	Standard Units per c.c.
<b>DIATOMACEÆ:</b>														
Asterionella.....				8			4				12	24	0.35	9
Cyclotella.....	1		3	1				4			16	32	0.1	3
Melostræ.....	10	12	12	11	9	7	22	19	37	11	150	300	0.5	150
Navicula.....	2	5	8	4	2	7	6	4	7	6	51	102	1.0	102
Synedra.....	3	1	1	2	2		2	4	2	2	19	38	1.0	38
Tabellaria.....	6		7		10	8		5	6		42	84	1.0	84
Cymbella.....		1		2	1	2	1	4	3		13	26	1.0	26
Cocconeis.....	1		2		2					4	10	20	0.5	10
<b>CHLOROPHYCEÆ:</b>														
Closterium.....	1			1	1				1		4	8	5.0	40
Pediastrum.....		1	1			1	1				5	10	10.0	100
Protococcus.....	2		4	3		5	2	1	6	5	28	56	1.0	56
Scenedesmus.....	1	3	1	2		2		1	2	3	15	30	0.5	15
Staurastrum.....		1	1				1				3	6	3.0	18
Spirogyra.....					30						30	60	—	60
Pandorina.....	1	1				1	1				4	8	10.0	80
<b>CYANOPHYCEÆ:</b>														
Anabæna.....	80	90	160	130	240	70	110	150	100	110	1240	—	—	2480
Chroococcus.....			5		25		5				10	20	1.0	20
Clathrocystis.....					25						25	—	—	50
Cælosphærium.....	40	30	75	40	25			90	75	35	470	—	—	940
Microcystis.....			10		10	10					30	—	—	60
<b>FUNGI AND SCHIZOMYCETES:</b>														
Crenothrix.....		2		1		1		2	2		8	16	1.0	16
Mold Hyphæ.....			2		2						4	8	1.0	8
Cladothrix.....							2				2	4	1.0	4
<b>PROTOZOA:</b>														
Dinobryon.....			10				8				18	36	0.5	18
Mallomonas.....					1				1		2	4	2.0	8
Peridinium.....	1	2			1			1			5	10	6.0	60
Synura.....			10		10						20	—	—	40
Trachelomonas.....	1		1				1		2		6	12	1.0	12
Cryptomonas.....		1			1						2	4	1.0	4
Codonella.....									1		1	2	8.0	16
Ceratium.....							1				1	2	10.0	20
<b>ROTIFERA:</b>														
Anuræa.....			1								1	2	20.0	40
Polyarthra.....					1						1	2	25.0	50
<b>CRUSTACEA:</b>														
Cyclops.....												Present		
<b>OTHER ORGANISMS:</b>														
Anguillula.....		1									1	2	5.0	10
<b>TOTAL ORGANISMS.....</b>														
AMORPHOUS MATTER.....	20	25	40	25	15	40	20	30	35	20	270	—	—	4647
MISCELLANEOUS BODIES.....												—	—	540
Sponge Spicules.....											3	6		6

the former sometimes contained a thousand times as much organic matter as the latter. In order to make the figures representing the total number of organisms bear some close relation to the actual character of the water as shown by the physical and chemical analyses, it was suggested that the standard unit already in use for the amorphous matter might be applied to the organisms as well. This "standard unit method" was adopted at the Boston Water Works, and was soon used extensively elsewhere. Its use is now almost universal.

The unit system does not involve much extra labor in the counting. Many organisms are so constant in size that they may be counted individually and then reduced to standard units by multiplying by a constant factor. Filamentous forms of constant width may be measured in length and then reduced to units. Irregular masses and variable colonies may be estimated directly in units. In practice it has been found desirable to modify the unit somewhat in cases where organisms are especially thick or thin in order that the results may approximate a volumetric determination as nearly as possible.

It is not always that the unit system gives better results than the counting system. Sometimes it is advisable to state the results both in number of individuals and in standard units.

**Records.**—The results of analysis may be recorded on a blank similar to the one shown on page 44. The ten numbered vertical columns correspond to ten squares counted. The three right-hand columns give the number of organisms per c.c., the average size of the organisms and the final result in Number of Standard Units per c.c.

The names of the common organisms are printed in the left-hand column, and are grouped according to the system of classification described in Part II. The table on page 46, shows the schedules of classification used by different observers. It may be found useful in the comparison of different reports.

**The Planktonokrit.** The planktonokrit is a modification of the centrifugal machine. The water to be examined is placed in two funnel-shaped receptacles attached to an upright shaft, with the necks of the funnels pointed outward. The receptacles

have a capacity of one liter each. The funnel portion is made of tinned copper; the stem is a glass tube that has a bore of  $2\frac{1}{2}$  to 5 mm. The glasses are held in place by a cover, such as is employed in mounting a water-gauge. The shaft is driven by hand or belt through a series of geared wheels, so arranged that 50 revolutions of the crank, or pulley-wheel, produce 8000 revolutions of the upright shaft. By this rapid revolution of the sample the organisms are thrown outward by centrifugal force and collect in the neck of the funnel, from which they may be removed for examination.

SCHEDULES OF CLASSIFICATIONS USED AT DIFFERENT TIMES  
AND IN DIFFERENT LABORATORIES.

INDIVIDUAL COUNTING SYSTEM.				STANDARD UNIT SYSTEM.	
<i>Mass. St. Bd. of Health. Parker, 1887.</i>	<i>Boston Water Works. Whipple, 1889*</i>	<i>Mass. St. Bd. of Health. Calkins, 1890.</i>	<i>Conn. St. Bd. of Health. 1891.</i>	<i>Brooklyn Water Dept. Whipple, 1897.</i>	<i>Boston Water Works. Hollis, 1897.</i>
Diatomaceæ	Diatomaceæ	Diatomaceæ	Diatomaceæ	Diatomaceæ	Diatomaceæ
Desmidiæ Palmellaceæ Zooporeæ Zygnemaceæ Volvociniæ	Desmidiæ Chlorophyceæ	Algæ	Desmidiæ Protococoidæ Confervaceæ	Chlorophyceæ	Chlorophyceæ
Cyanophyceæ	Cyanophyceæ	Cyanophyceæ	Cyanophyceæ	Cyanophyceæ	Cyanophyceæ
Schizomycetes	Fungi	Fungi	Fungi	Fungi and Schizomycetes	Fungi
Protozoa	Rhizopoda Infusoria	Rhizopoda Infusoria	Rhizopoda Infusoria	Protozoa	Rhizopoda Infusoria
Rotifera	Rotifera	Vermes	Rotifera	Rotifera	Rotifera
Entomostraca	Crustacea	Crustacea	Crustacea	Crustacea	—
Spongiaria Nematoda Annelida	Miscellaneous	Miscellaneous (including Zooglœa)	Ova Spores	Other Organisms	Miscellaneous
—	Total Organisms	Total Organisms	—	Total Organisms	Total Organisms
	Amorphous Matter			Amorphous Matter	Amorphous Matter
				Miscellaneous Bodies	—

\* The Standard Unit System has been used since Jan. 1, 1893.

There are certain practical objections to the forms of apparatus now constructed. It is not only difficult but dangerous to use high speeds when large quantities of water are operated on. Field has been unable to use a speed greater than 3000

revolutions per minute. This speed maintained for four minutes, however, was sufficient to throw out all the organisms except the Cyanophyceæ. By reducing the volume of the samples and by perfecting the mechanical parts of the apparatus it seems probable that excellent results may be obtained by this method.

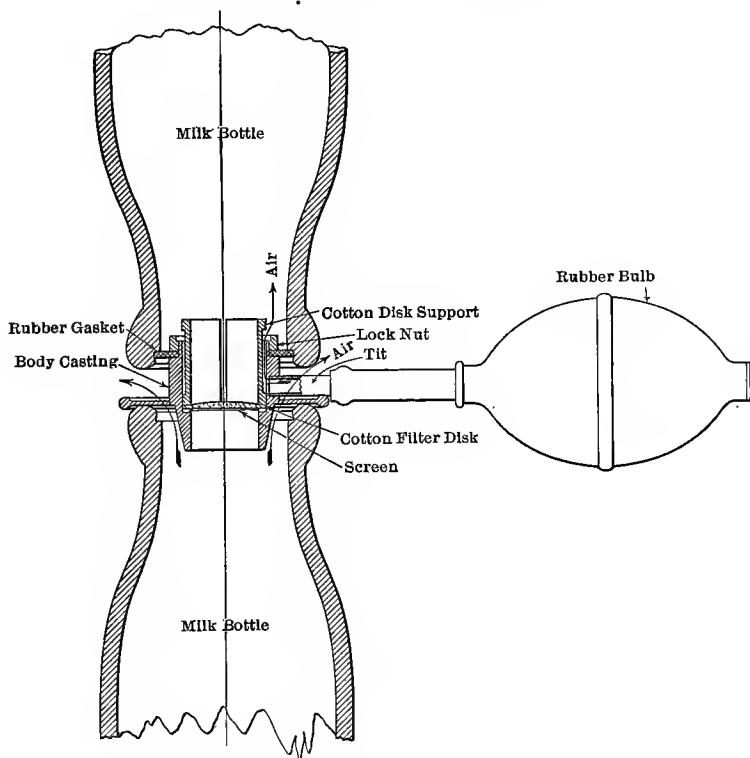

FIG. 19.—The Wizard Sediment Tester.

**Filtration Through Cotton.**—An interesting and valuable method of keeping a permanent record of the amount of suspended organic matter in water is that of filtering a large volume of water through a thin sheet, or plug, of cotton. While this method is not one of great accuracy from the standpoint of the analyst it is an excellent one for showing to the eye the changes which take place in the algæ growths in public water-supplies.

The best method is that which was originally devised for the determination of dirt in milk known as the Wizard Sediment Tester, made by the Creamery Package Manufacturing Company of Albany, N. Y. The filtering medium is a thin plug of cotton about an inch in diameter which is held between two supports of wire cloth in a cap attached to a glass milk bottle. The water to be filtered is placed in the bottle and allowed to flow out through the cotton. Filtration is hastened by increasing the pressure of the air within the bottle by the use of a simple air compressor operated by a hand bulb. In order to

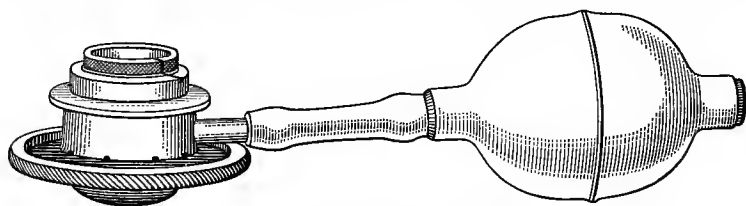

FIG. 20.—Air Compressor for Use with the Cotton Filter.

filter a sufficient volume of water the bottle has to be filled several times. The relative abundance of algæ or other suspended matter in the water is shown by the discoloration of the cotton. Figs. 19 and 20 show the apparatus and Plate A illustrates the variations in the appearance of the cotton after filtering samples of Cambridge water on different days. The amount of water filtered in each case was five quarts.

The author has been strongly impressed with the practical value of this method and believes that it should be very generally used by water-works superintendents. It would form a useful addition to the field equipment for testing water. It is inexpensive.

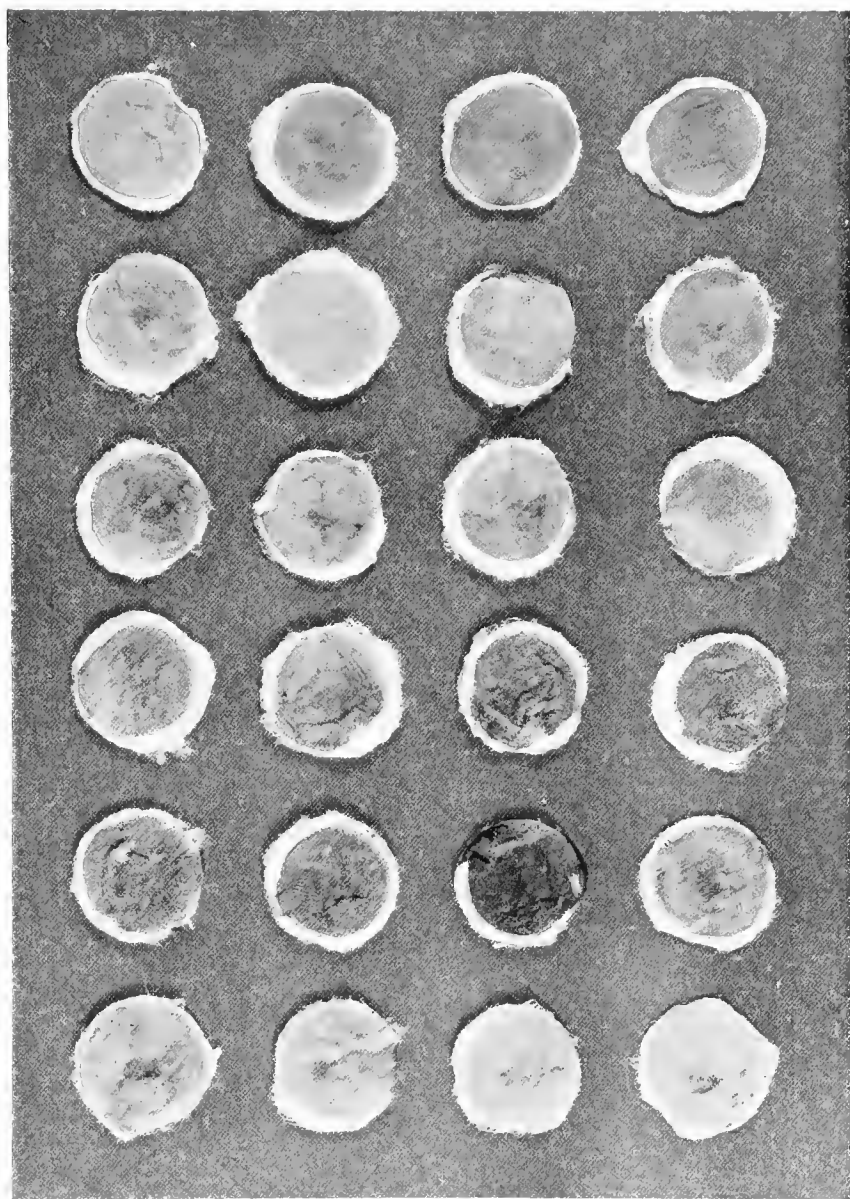

PLATE A

Sediment (chiefly algæ) from Cambridge Tap Water Collected on Cotton Discs at Different Times during the Autumn of 1913.



## CHAPTER V

### THE MICROSCOPE AND ITS USE

By JOHN W. M. BUNKER, Ph.D.

To obtain satisfactory results from the use of the microscope one must be familiar with the construction, use, and care of the instrument, and have an intelligent understanding of the optical principles of magnification. The microscope, like any other finely adjusted optical instrument requires intelligent care, and is easily injured by a person not familiar with it. The object of its use is to have presented to the eye a clear image which is larger than the object viewed. The size and clearness of the image obtained with any instrument are dependent largely upon its manipulation.

**Construction of the Microscope.**—The compound microscope is a system of lenses set in a mounting suitably adjustable for their manipulation. The first microscope known was essentially this, being a glass bead mounted on a wire loop. The supporting parts of the modern microscope are the results of years of experience and study, and since the needs are the same, are similar in all the best microscopes.

There is always a *base* (*B* Fig. 21) of heavy metal, into which is cast a *pillar* (*P*), which in turn is joined to a flat *stage* (*S*) for supporting the object to be examined. An *inclination joint* (*I*) allows the stage and attached portions to be tipped as a unit to any convenient angle. Moving with the stage and supporting the optical parts is the *handle arm* (*HA*) which carries the *body tube* (*T*). This tube receives at its lower end by means of a society thread fitting known as the *nose-piece* (*RN*) a brass mounting containing the first set of lenses, known as the

*objective (O)*. At its other end the body tube receives an extension known as a *draw tube (D)* by means of which the optical

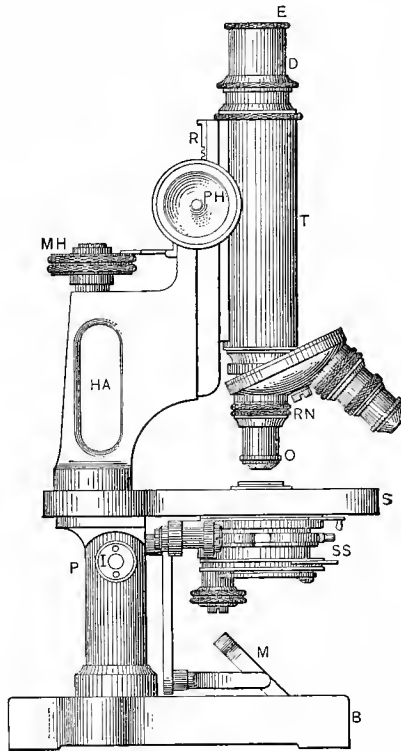

FIG. 21.—Compound Microscope Suitable for the Examination of Water.

E	Eyepiece.	S	Stage.
D	Draw tube.	SS	Substage.
T	Body Tube.	M	Mirror.
RN	Revolving Nose-piece.	B	Base.
O	Objective.	R	Rack.
PH	Pinion Head.	P	Pillar.
MH	Micrometer Head.	I	Inclination.
HA	Handle Arm.		

path is lengthened or shortened. The upper end of the draw tube carries the second set of lenses in a slip fitting known as the *eyepiece (E)*.

By varying the distance of these two sets of lenses from the object viewed the clarity of the image is affected. By changing the distance of these two sets of lenses from each other, the size of the image is affected. When in the position where the greatest clearness is present, the lenses are said to be in focus, and the adjustment of the system to attain this position is called focusing.

To make focusing easy and certain, the body tube is attached to the handle arm by means of a tongue and groove joint which allows motion in a vertical line through the agency of rack and pinion adjustment screws. There are two of these, the *coarse adjustment pinion head (PH)* operating directly to bring about a considerable movement, and the *fine adjustment micrometer head (MH)* working by means of a lever to move the body tube very slowly.

Every microscope is fitted also with a *mirror (M)* for reflecting the light used for illumination up through the aperture in the stage to the object under examination. In the best microscopes there is an optical arrangement of lenses in a convenient mounting swung below the stage in the path of light known as the *condenser (SS)* which reduces the volume of light admitted to the object, at the same time intensifying it.

**Use of the Microscope.**—The bench upon which the microscope is to be set should be at such a height that observations can be made without straining the back of the neck or, on the other hand, compressing the chest. To this end an adjustable stool is desirable.

The microscope should always be used in an upright position owing to the liquid nature of the cell contents to be examined, and the observer should adjust the height of his stool so that he shall sit as upright as is compatible with comfort. Rest the arms on the table as much as its height will permit.

Bring the heel of the microscope to the edge of the table. Grasp the milled head of the draw tube with one hand while holding the body tube with the other, and with a spiral pull bring the tube to the standard length for which the objectives

are corrected.\* Lower eyepiece into draw tube, attach objective, place object on stage, adjust illumination, and focus on the object.

**Placing the Eyepiece.**—The exterior surface of the eye-lens and field-lens, being exposed, are apt to become dusty, and should always be carefully cleaned before using. Lens surfaces should be cleaned only with lens paper or a camel's hair brush. Eyepieces should be so loosely fitted that they will drop into the tube as far as the collar by their own weight. Care must be used in placing the eyepiece, or sliding the draw tube, as the objective may be forced against the object and thus destroy it, or injure the lens.

An eyepiece magnifying ten times is most convenient for water work.

**Attaching the Objective.**—Taking the objective (16 mm.) from its box, see that its front lens is clean; elevate the body tube by means of the coarse adjustment (*PH*) so that the nose-piece (*RN*) shall be at least two inches from the stage (*S*).

To properly attach an objective is not always simple, and cannot be done too carefully. There is danger of dropping the objective onto the object, thereby damaging either or both, also of starting the threads wrongly by holding the objective sideways, and thus injuring the threads.

Grasp the upper knurled edge of the objective between thumb and forefinger of the left hand; bring the screw in contact with the screw of the nose-piece, and, keeping the objective in line with the tube and gently pressing upward, revolve the objective with the thumb and forefinger of the right hand by the lower milled edge until shoulder sets against shoulder.

**Finding an Object.**—In general practice, a low power objective is used to find and center an object, after which the power under which it is to be studied is swung into place. In water work, however, the low power of magnification involved makes the use of any other objective superfluous. By grasping the slide containing the object with the thumb and the first or second finger of the right hand and racking the objective to about

\* Bausch and Lomb, 160 mm.; Carl Zeiss, 160 mm.; Ernst Leitz, 170 mm.

three-eighths of an inch from it and then passing the slide to and fro, the shadow of the image can usually be seen as the object flits by.

**Illuminating the Object.**—Illumination is an extremely important detail, and should always be carefully regulated, as one may easily fail to obtain the best results, may be led to wrong conclusions, or may injure the eyes. The mirrors (*M*) of the microscope are usually plane and concave, and are adjustable so as to be able to reflect the light from any source in front or at the side of the microscope.

The plane mirror reflects the light in its initial intensity; the concave mirror concentrates the rays on the object, thereby giving intensified illumination.

*When a substage condenser is used, the plane mirror is employed.*

The sources of light are either daylight or artificial light. If the former the light of a northern sky is preferred, and if the latter a Welsbach gas burner. An ordinary gas flame should not be used on account of the difficulty of obtaining even illumination and the constant flickering which is injurious to the eyes. If using a flat-wick lamp the narrow edge of the flame should be used, as this is more intense than the broad side.

In general, artificial light will give better color values if the blue glass screen is inserted in the clip below the substage condenser. It is, even under the best conditions, not to be compared with daylight from the point of view of desirability.

When using daylight, place the microscope as nearly as possible before a window. If artificial light must be employed, set it in front of the microscope or at one side with a screen between so adjusted on a stand that the upper part of the microscope and the eye of the observer are shaded from the light which is allowed to fall below the screen onto the mirror.

Light is transmitted to illuminate transparent objects, and passes through the object from below the stage into the objective. With opaque objects this is impossible and reflected light is required, which is directed onto the object from above and

illuminates its upper surface. In the following instructions it is assumed that transmitted light is used.

Before lighting an object make certain that the mirror bar is in exactly central position, and set the mirror at such an angle to the light that it will be reflected upon the object, which can be done more quickly at the outset by observing the object or the opening of the stage, keeping the head at one side of the tube. Now remove the eyepiece, and observe the light coming through the objective. It should be central and of equal intensity, which with daylight is sometimes difficult to obtain as the sash of the window may be reflected and show itself in the field as dark bands, or in the case of lamplight the blue portion of the flame may appear as a dark spot. These are only preliminary directions but will suffice for a beginning. There will be little difficulty in obtaining proper illumination at the outset if one will observe the following:

Remove the eyepiece and, looking through the back of the objective, have

Central illumination.

Even illumination over entire field.

Mellow illumination.

Defects in illumination which may not be apparent will show when the eyepiece is replaced, and are indicated,

When dark points or shadows appear in the field.

When the outlines of an object are bright on one side and dark on the other.

When the object appears to lie in a glare of light.

In the first two cases the correction can be made by suitably adjusting the position of the mirror, in the last by reducing the amount of light by the use of the iris diaphragm between mirror and object.

It is now generally conceded that observations with the microscope may be made to any extent without any detrimental results to the eyes, provided, however, that the conditions of light are just right. It is a good rule to follow, to use as small an amount of illumination as will comfortably show the structure which is being studied, and it may also be safely accepted

that, if the eye tires or feels uncomfortable, the light should be moderated.

**Focusing.**—The act of focusing is merely the bringing of the objective to that distance from the object where a clear image is obtained. Care must be exercised against allowing the face of the objective to come in contact with the cover-glass, which is almost sure to bring injury to one or both. To that end,

#### ALWAYS FOCUS UPWARD

Having attached the 16 mm. objective to the nose-piece, lower the eyes to the level of the stage so as to be in a position to observe the face of the objective; lower the tube by the coarse adjustment until the face of the objective is one quarter of an inch from the object; look through the eyepiece and slowly revolve the coarse adjustment pinion head in a counter-clockwise direction, elevating the optical system until the image comes into view. With the left hand continue the adjustment of focus until a sharp image is obtained. At the same time, with the right hand, manipulate the iris diaphragm below the substage condenser until the amount of illumination is present which is optimum for your vision.

The upward movement should be slow so that, if the object be faint, it is not missed and the adjustment not run beyond its focal distance. It is possible that, in the case of a very minute object, it may be out of the center, and thus out of the field of vision, in which case the surface of the cover-glass, or the minute particles of dust upon it should be distinguishable.

The object will first appear with faint outlines and indistinct; then gradually more distinct, and finally sharply defined, and if adjustment goes beyond this point, it will gradually become dimmer, in which case return to the point of greatest distinctness.

It is also an aid in focusing on isolated specimens in a clear field to move the cell slowly in different directions, as the flitting shadows and colors moving across the field of view give warning of the approach of the focal point.

**Use of Substage Diaphragm.**—The purpose of the diaphragm mounted below the substage condenser is to modify the amount of light and by this attain sharpness of definition which otherwise would be impossible. By its use, so much light as would produce a glare is avoided as well as so small an amount that eye strain would result. The opening best suited varies with lighting, the density of the object observed, and the sensitiveness of the eye of the observer.

**Which Eye to Use.**—The writer has found it more convenient to use the left eye for observations, leaving the right free for the drawing paper or note-book without turning the head.

*Cultivate the habit at the outset of keeping both eyes open.*—There is a point just above the eyepiece called the eye-point at which rays cross within the smallest compass, and this is the proper position for the eye. When not at this point shadows or colors appear in the field which becomes reduced in size.

**Practice Exercises.**—1. Place a piece of lens paper torn apart as much as possible on a clean slide (the back of your counting cell will do) and place a drop of water on it. Lay the cover slip over the whole letting one edge touch the wet area first so that in falling the slip will force out under the other edge any air bubbles. Place this mounted preparation on the stage and focus on it.

2. Mount and examine in the same way a cotton fiber, a wool fiber, one of silk, a small pinch of dust.

3. Scrape the inside of the cheek with a clean glass rod or sliver of wood and wash it off carefully in a drop of water, mount and examine with light cut way down.

4. With a pin or sharp knife tease off a minute scale of the skin of an onion or a bit of celery, mount and examine.

5. Dissolve a small portion of yeast in warm water, let stand a few hours, and examine a drop of the liquid.

6. Scrape a bit of green from the north side of a tree and examine in a drop of water.

7. Soak a handful of hay chopped fine in a pint of water in a warm place for a few days. The liquid will be swarming with various micro-organisms.

8. Gather a bit of scum from a stagnant puddle and examine.

Ponds, ditches, stagnant pools, all are prolific sources of objects, animals, and plants which are interesting to observe and which accustom one to the appearance of microscopic life.

**Optics of the Microscope.**—The magnification brought about by a microscope depends upon the fact that rays of light passing from one medium to another at an angle become bent according to the angle at which they pass from the first medium to the second. By controlling this angle of incidence the degree of bending can be greatly increased, and lines of light which passing through the air, would meet the lens of the eye at a sharp angle are made, by the interposition of glass in the form of a lens to meet the eye in a wider angle. As the eye cannot differentiate such bent lines from straight ones, the sensation recorded upon the retina is that of viewing a large object. This is graphically shown in the accompanying diagram, Fig. 22.

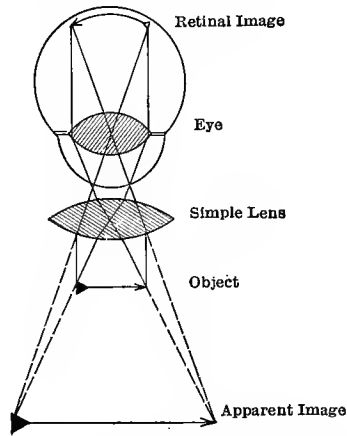

FIG. 22.—Optics of Simple Magnification.

If the rays of light from the object had not been intercepted by the lens of the eye they would have continued on to a point where they would have been again sorted out, as it were, and a sheet of paper held at this point would have shown a real image magnified and inverted. This principle is utilized in the compound microscope, in which a second simple lens (the eyepiece) picks up the magnified inverted real image formed in the tube of the microscope by the objective. This real image is again magnified and presented to the eye of the observer as a virtual image of the original object, greatly enlarged and turned end for end, cf. Fig. 23.

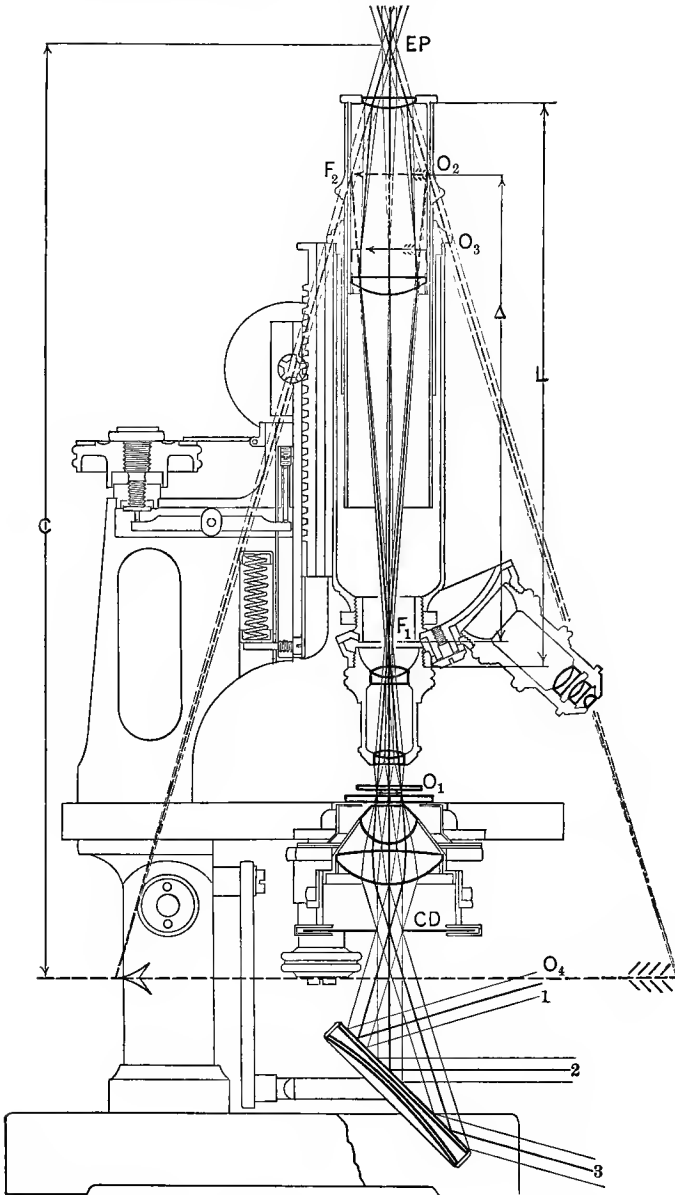

FIG. 23.—Optics of the Compound Microscope. After Bausch.

See opposite page for description of figure.

**Illumination.**—It is evident that too much care cannot be taken to secure the proper adjustment of illumination. Hence the manipulation of the condenser is all important. As previously mentioned only the plane mirror should be used with a condenser. The optical reason for this is shown in Figs. 24, 25 and 26.

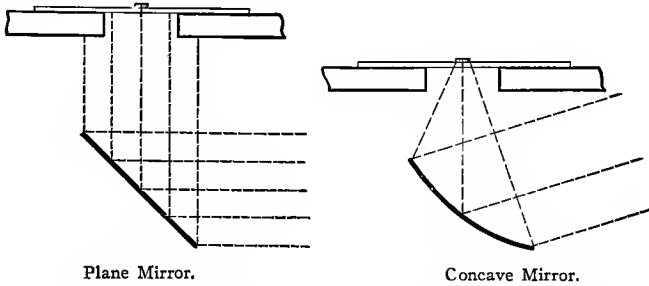

FIG. 24.—Methods of Illuminating Objects with Plane and Concave Mirrors.

**Care of the Microscope.**—Besides acquiring the ability to use an instrument with its accessories, it is important to know how to keep it in the best working condition. It may be said without reserve that an instrument properly made at the outset and judiciously used should hardly show any signs of wear either in appearance or in its working parts, even after the most protracted use.

### Index to Fig. 23.

- $F_1$  Upper focal plane of objective.
- $F_2$  Lower focal plane of eyepiece.
- $\Delta$  Optical tube length = distance between  $F_1$  and  $F_2$ .
- $O_1$  Object.
- $O_2$  Real image in  $F_2$ , transposed by the collective lens, to
- $O_3$  Real image in eyepiece diaphragm.
- $O_4$  Virtual image formed at the projection distance  $C$ , 250 mm. from
- EP Eye-point.
- CD Condenser diaphragm.
- L Mechanical tube length (160 mm.).
- 1, 2, 3 Three pencils of parallel light coming from different points of a distant illuminant, for instance, a white cloud, which illuminate three different points of the object.

Especial care should be given to the optical parts, in fact such care that they will remain in as good condition as when first received, after any amount of use.

**Care of the Stand.**—Keep free from dust is one of the first rules to be observed. When not in use place the microscope in its case, or cover with a bell jar or close-mesh cloth such as

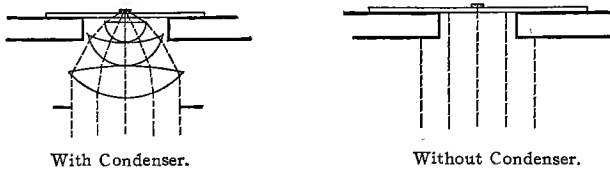

FIG. 25.—Path of the Illuminating Rays with and without the Use of a Condenser.

cotton flannel or velvet which should reach to the table. If dust settles on any part of the instrument remove it first with a camel's hair brush and then wipe carefully with a chamois skin, wiping with the grain of the finish of the metal and not across it, as in the latter case it is likely to cause scratches.

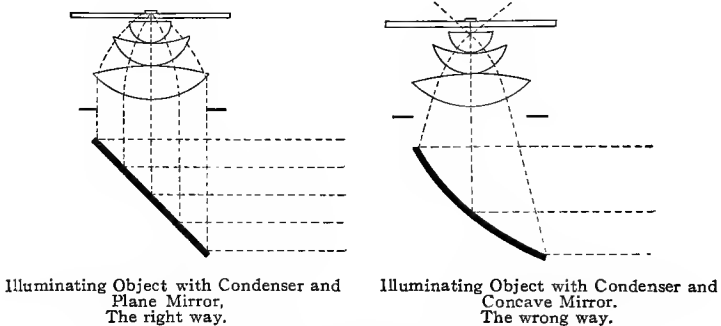

FIG. 26.—Illumination with Plane and Concave Mirrors.

When handling the stand, grasp it by the pillar or handle arm. While the arm is the most convenient part it is at the same time the most dangerous to the fine adjustment except in instruments of the handle-arm type.

Avoid sudden jars, such as placing upon the table or into the case with force.

Remove any Canada balsam or cedar oil which may adhere to any part of the stand with a cloth moistened with xylol and wipe dry with chamois.

Use no alcohol on lacquered parts of the instrument as it will remove this finish. As the latter is for the purpose of preventing oxidization of the metals, it is important to observe this rule. Parts finished in black are usually alcohol proof.

To use the draw tube impart the spiral motion.

Before using a screw driver grind its two large surfaces so that they are parallel and not wedge-shaped, so it will exactly fit in the slot of the screw-head. Turn the screw with a slow steady motion pressing the screw-driver firmly into the slot. No screw-head will ever be injured if these points are observed.

**Care of the Coarse Adjustment.**—Special care should be given to keep the coarse adjustment free from dust as its effect is particularly pernicious. The slides and rack and pinion are necessarily exposed and the lubricant is apt to catch dust and also to gum. The tube should be occasionally withdrawn from the arm and the slides carefully wiped with a cloth moistened with xylol. Lubricate by applying a small quantity of paraffine oil to a cloth and wiping well over the surfaces, removing the superfluous amount with a dry cloth. The teeth of neither rack nor pinion should ever be lubricated. An occasional cleaning of the teeth with an old tooth brush is advisable.

It is advisable occasionally to lubricate the pinion shank on both sides of the arm with a very minute quantity of paraffine oil.

If the pinion works loose from jar incident to transportation or long use, which sometimes occurs to such an extent that the body will not remain in position, increase the friction upon it by tightening the screws on the pinion cover.

**Fine Adjustment.**—In a general way it may be said that if the fine adjustment ceases to work satisfactorily the instrument had better be returned to the maker, as it involves the most delicate working and few people are conversant with its construction. There is very seldom any occasion for this, however, if used with reasonable care.

If the fine adjustment does not respond to the turning of the micrometer screw, or if it comes to a stop, it indicates that the adjustment screw has come to the limit of its motion at either end. It should by no means be forced; it should at all times be kept at a medium point.

**Care of Lens Surfaces.**—No dust should be allowed to settle on the eyepiece nor should any lens be touched by a finger. Occasional cleaning is desirable on all surfaces, however. To accomplish this use a camel's hair brush to remove dust, breathe upon the surface, and imparting a spiral motion to the lens wipe it gently with lens paper. Hold in the blast of a fan, or dust with a camel's hair brush to remove final fibers that may adhere.

**Eyepiece.**—Visible defects in the field are always traceable to impurities in the eyepiece, not in the objective, and are easily recognized by revolving it. Indistinctness in the image or loss of light may be due to soiled or coated surfaces in either eyepiece or objective.

Dust if on either the eye-lens or field-lens is apparent as dark, indistinct spots.

**Objective.**—This should be used with the utmost care. The systems should never be separated, even if they can be unscrewed, as they are liable to become decentered and dust may enter.

Avoid all violent contact of the front lens with the cover glass.

Occasionally examine the rear surface of the objective with magnifier and if dust be present remove with camel's hair brush.

While cleaning give the objective a revolving motion.

If any part of the microscope cannot be brought to a satisfactory working condition by the foregoing instructions, or any part is injured by accident it should invariably be sent to the maker or to a reliable manufacturer of microscopes.

**Measurement of Microscopic Objects.**—In measuring objects viewed through the microscope, it is necessary to have two scales, one fixed for all conditions, and the other variable for

each magnification. These scales are called micrometers. The fixed scale is an arbitrary one and may take the form of parallel lines with each tenth one accentuated, or of rectangles of varying or similar sizes, or any recurring geometric form. It is placed on the diaphragm of the eyepiece which is set by the makers at that plane in the eyepiece at which the real image is projected by the objectives. In looking through such a system the real image of the object under observation will coincide with the lines etched on the eyepiece micrometer and will be projected with them into the eye of the observer. It is possible then to express either the length or breadth of this object in terms of unit divisions by careful inspection.

To calibrate a given microscope is merely to determine the actual value in terms of linear measurement of each of these units for a given fixed condition of magnification. This is done by placing upon the object stage a slip of glass accurately ruled off into certain suitable divisions of known length. This slip is called the object micrometer. It is customary for such a micrometer to have a space of 1 mm. accurately divided into one hundred parts with each tenth division suitably indicated. By focusing upon this ruled portion it is possible to read off on the eyepiece micrometer the equivalent in hundredths of a millimeter of each of its divisions.

This gives the *apparent image value* of a known distance (1 mm.) in terms of the eyepiece micrometer units which value can then be substituted for the equivalent in eyepiece units in determining the length of any object observed.

It is customary in micrometry to take as a unit of length the distance one one-thousandth of a millimeter which unit of measurement is called the micron (plural, micra) whose symbol is the Greek letter  $\mu$ .

If the lines of the stage micrometer do not coincide with any divisions in the eyepiece micrometer, they can be made to do so by increasing the length of the draw tube by pulling it out with a rotary motion.

Once the proper position is obtained the tube length should be read from the graduations on the draw tube and recorded,

along with the power of the eyepiece and of the objective and the eyepiece micrometer value.

*This instrument at this tube length, with the same ocular and objective will always have the same micrometer value when in focus.*

A new departure in the ruling of eyepiece micrometers is shown by the Leitz step micrometer shown in Fig. 27.

In this micrometer the intervals are arranged in groups of ten, each group being set off by a black echelon rising from the first interval. The intervals instead of being  $\frac{1}{10}$  or  $\frac{1}{20}$  mm. wide, as is usually the case, have a definite value of .06 mm. in order to obtain for each objective at the Leitz tube length (170 mm.) convenient and integral micron values for these divisions.

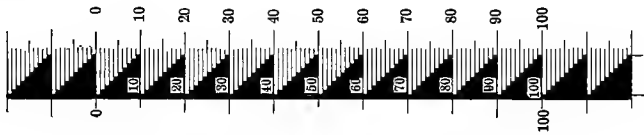

FIG. 27.—Leitz Step Micrometer. (Stage Micrometer.)

In the enumeration of micro-organisms a special form of eyepiece micrometer has proved to be convenient. This consists of a ruled square of such a size that with a 16 mm. objective and a 10x eyepiece and the proper tube length the area covered by it on the stage is one square millimeter. It is further subdivided into four equal squares one of which is further divided into twenty-five equal squares, each of which will cut off on the stage  $\frac{1}{10}$  of a millimeter. The square nearest the center is again subdivided into twenty-five equal squares each of which measures  $20\mu$  on a side. The area of one of these smallest squares is a convenient unit for estimating the area of micro-organisms and is called a *standard unit*. (Fig. 18.)

**Magnification.**—Magnification is the ratio between the linear size of the object and the size of its visual image. It may be determined by the use of a device which allows the image to be projected virtually onto a sheet of paper at the side of the

microscope which may then be measured by dividers while the observer is looking down through the scope with both eyes open. This is known as a camera lucida and will be explained elsewhere.

If the observer use a stage micrometer he can measure the size of the virtual image of 1 mm. which will give directly the magnification. Magnification can be varied by one of three methods:

By using a higher or lower powered objective.

By using a higher or lower powered eyepiece.

By varying the length of the tube of the microscope.

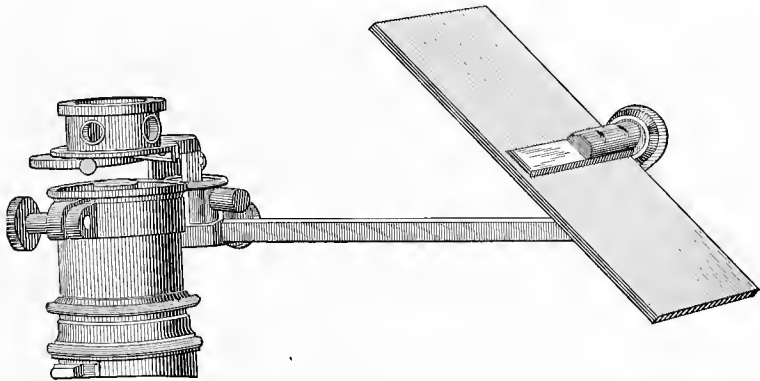

FIG. 28.—Abbé Camera Lucida.

**Drawing and Photographing Organisms.**—There are two ways in which the study of micro-organisms may be accelerated and the results made permanent. As new species are met with and identified it is useful to have their pictures for further reference.

An accurate drawing can be made to scale by the use of a simple attachment known as the camera lucida, by which the drawing surface and the visual field are superimposed in the eye so that it appears that the visual image is projected onto the drawing board where its outlines can be traced with a pencil.

The best form is that of the Abbé camera lucida which is depicted in Fig. 28.

It should be noted that in drawing with the camera lucida it is necessary to have the drawing board tilted a little so that the vertical from it to the center of the mirror is at a right angle to the center of the board. Usually the stage of the microscope interferes if the mirror is set at exactly  $45^{\circ}$  and the board laid flat.

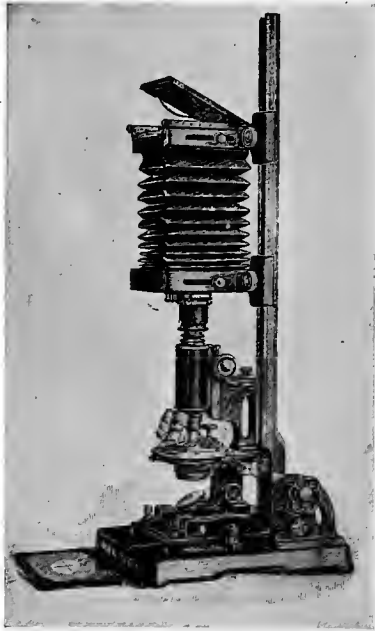

FIG. 29.—Photomicrographic Camera.

A more accurate reproduction can be made with the camera. Any camera box of the bellows type with sufficiently long extension can be utilized by replacing the lens with a collar over which a black bag can be tied, the other end being fastened over the tube of the scope. The camera should be supported by a ring stand or special support directly over the microscope in such a position that the ground glass screen

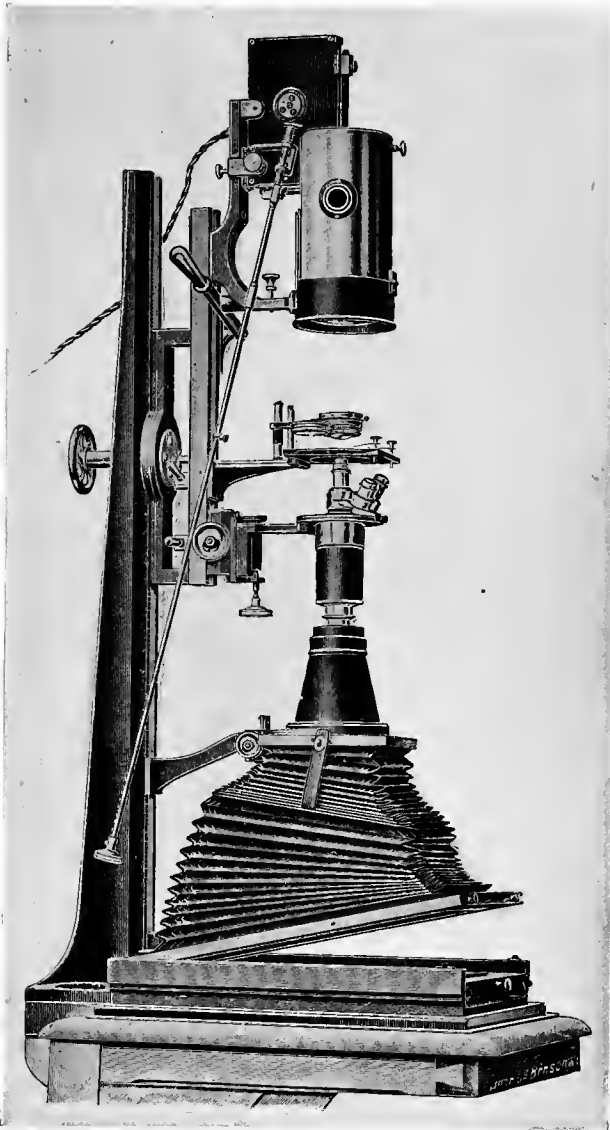

FIG. 30.—Edinger Drawing and Projection Apparatus Adapted for Photomicrography.

is about 10 inches above the eyepiece. By bringing the microscope to a focus, a real image is projected onto the ground glass screen which may be photographed. Strong artificial illumination is necessary.

A camera box for this purpose can be purchased from any of the standard optical companies. See Fig. 29.

For really good results a rigid frame with adjustments for manipulating the magnification, light, color screens etc., is desirable. These are made in different sizes and cost from \$200 and upward.

The author has found the Edinger drawing and projection apparatus fitted with a camera bellows, satisfactory for photo-

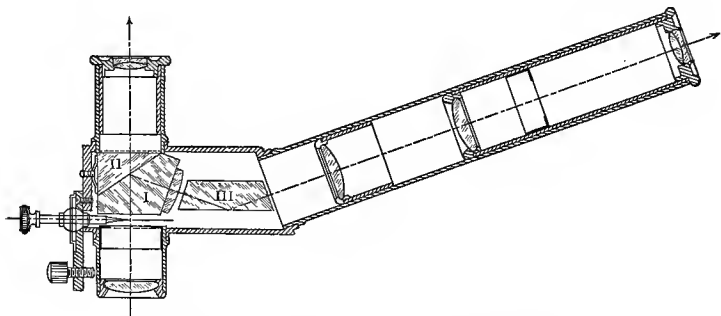

FIG. 31.—Leitz Double Demonstration Eye-piece.

graphing micro-organisms. It is rigid, easily manipulated, and with it the amateur need waste very few plates to obtain excellent results. The photomicrographs appended herewith were made on this instrument. It takes standard eyepieces and objectives so that this equipment need not be duplicated. The same instrument can be used for drawing by removing the camera bellows and substituting a drawing board for the ground glass focusing screen.

**Projection.**—For introducing classes to the study of the microscopic organisms, and for demonstrating unusual species some form of projection may be profitably employed—either the direct microscopic projection of specimens in their natural

state or lantern slides of photomicrographs may be employed. For the former any of the standard micro-projective or photomicrographic apparatus may be adapted, but it is unsatisfactory owing to the difficulty of bringing an object mounted in fluid

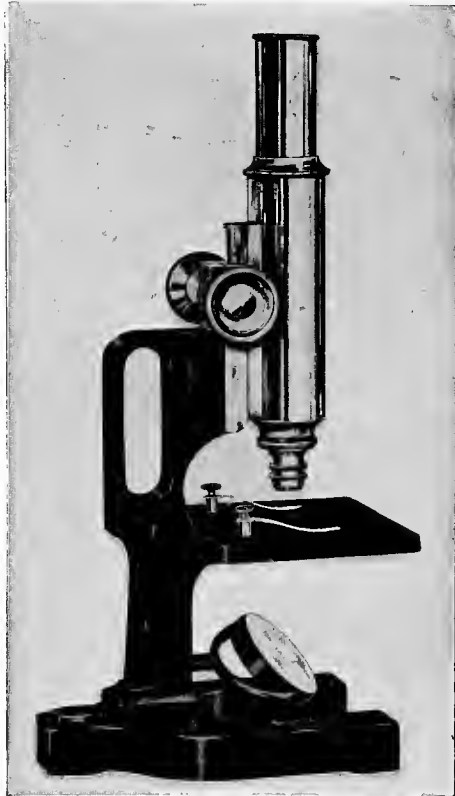

FIG. 32.—Type of Microscope Suitable for the Examination of Microscopic Organisms in Water.

to a focus in one plane. The short distance from the microscope at which the screen must be placed in order to retain a sufficiently brilliant image, and the impossibility of rendering true colors by artificial light are also objections.

Lantern slides of photomicrographs, if properly colored,

give an accurate picture that is permanent and portable. A crudely colored slide is, however, less desirable than one in monochrome.

Color photography is a newly opened field to the microscopist. It is said that the new duplicating process of the Paget Company of London makes it possible to print any number

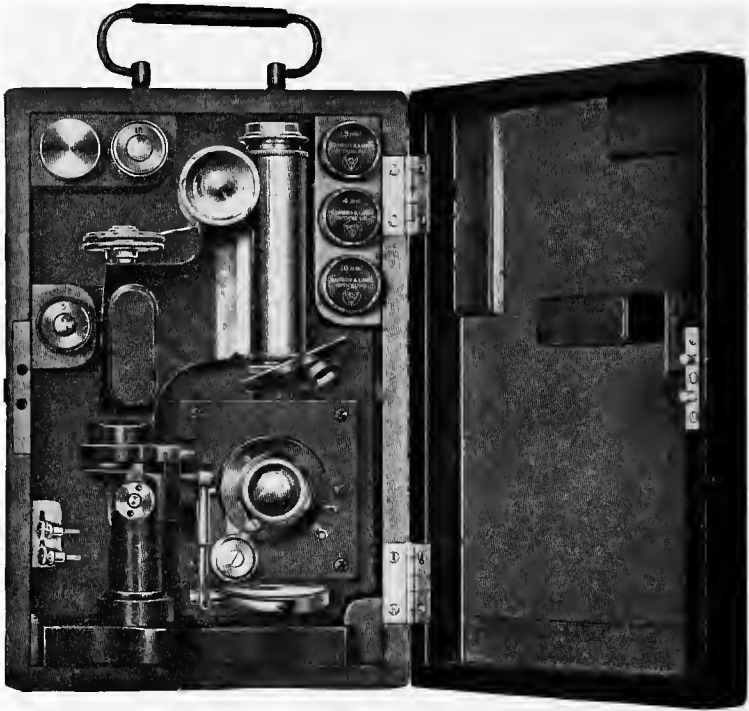

FIG. 33.—Bausch and Lomb's Portable Microscope.

of panchromatic slides from one properly taken negative. The process, still in its infancy, involves manipulations that bar it from the ordinary amateur, but which are not insurmountable to the photographer of some experience. It is to be hoped that attention will be given in the future to the development of the means of increasing the pleasure and the profit of studying microscopic organisms through the medium of color-photomicrography and projection.

**Demonstration Eyepiece.**—In class work and for simultaneous examination of objects by two observers the Leitz double demonstrating eyepiece is valuable. This eyepiece fits any standard tube, and contains a prism which deflects 30 per cent of the light rays collected by the field-lens through a side tube to a second eye-lens, allowing 60 per cent to travel in their normal course, 10 per cent being lost. The eyepiece is equipped with a pointer on a universal joint in the plane of the real image so that structures pointed out by either observer are brought to the attention of the other. (Fig. 31.)



FIG. 34.—Microscopical Field Work at Squam Lake. Harvard Engineering School Course in Limnology.

**Field Work.**—In the examination of water in the field a light portable outfit is desirable. For a low priced but efficient microscope that made by Bausch & Lomb and illustrated in Fig. 32 is sufficient. A 10x eyepiece should be specified instead of the one usually furnished.

Folding microscopes are also made whose equipment is of the best. These are satisfactory, though about twice as expensive as regular styles.

In addition the field equipment should contain a sling filter for concentrating organisms, a counting cell or two, and a sup-

ply of cover-glasses which are very liable to be broken in the field.

Field work is most important as there one can get the organisms in a fresh state and study their distribution in a thorough manner doing away with the difficulty of transportation of samples.

Fig. 34 shows how it can be carried on under very pleasurable circumstances.

#### REFERENCES

- BAGSHAW, W. 1909. *Elementary Photomicrography*. London. Iliffe & Sons, Ltd.
- BARNARD, J. E. 1911. *Practical Photomicrography*. London. Edward Arnold.
- BAUSCH, E. 1901. *Manipulation of the Microscope*. Rochester. Bausch & Lomb Optical Co.
- CARPENTER, W. B., and DALLINGER, W. H. 1891. *The Microscope and Its Revelations*. Philadelphia. P. Blakiston, Son & Co.
- GAGE, S. H. 1904. *The Microscope*. Ithaca. Comstock Publishing Co.
- HANAUSEK, T. F. 1907. *The Microscopy of Technical Products*. New York. John Wiley & Sons.
- SPITTA, E. J. 1909. *Microscopy*. London. John Murray.
- WINSLOW, C.-E. A. 1905. *Elements of Applied Microscopy*. John Wiley & Sons, New York.
- WRIGHT, SIR A. E. 1907. *Principles of Microscopy*. New York. Macmillan Co.

## CHAPTER VI

### MICROSCOPIC ORGANISMS IN WATER FROM DIFFERENT SOURCES

IN studying the distribution of microscopic organisms in nature it will be convenient to consider the following classes of water-supplies separately:

1. RAIN-WATER.

2. GROUND-WATER.

*Springs, Wells, Infiltration-galleries, Infiltration-basins.*

3. SURFACE-WATER.

*Streams, Canals, Ponds, Small Natural Lakes, Artificial Reservoirs, Great Lakes.*

4. FILTERED WATER.

**Rain-water.**—Rain-water is perhaps the purest water found in nature, yet it sometimes contains micro-organisms. For the most part they are so minute that an examination by the Sedgwick-Rafter method fails to reveal them, but larger forms are sometimes observed.

The study of the organisms found in rain-water is really the study of the organisms found in the air. It is worthy of more attention than has been given to it. The presence of organisms, or their spores, in the air may be demonstrated by sterilizing some water rich in nitrogenous matter and exposing it to the air in the light. After a week or two it will contain numerous forms of microscopic organisms which must have settled into the liquid from the air or developed from spores floating in the air.

Rain-water collected in a sterilized jar and allowed to stand protected from the air often develops a considerable growth of algæ, usually some *Protococcus* form, showing that

the rain has not only taken up the organisms or their spores, but has absorbed sufficient food material for their growth. Samples of rain-water sometimes contain a surprisingly large amount of nitrogenous matter, especially if collected in the vicinity of a large city and at the beginning of a storm.

It has been noticed frequently that vigorous growths of algæ have appeared in ponds or reservoirs immediately after a rain-storm, the growth occurring suddenly and simultaneously throughout the whole body of water. It has been suggested that these sudden growths may be caused by the dried spores of the algæ being lifted from the shores of the ponds and scattered through the air by the wind, and then washed into the water by the rain. This supposition is in harmony with the theory that in the case of certain algæ sporadic development occurs only after the desiccation of the spores.

**Ground-water.**—Ground-water is water that has filtered or percolated through the ground. It comes to the surface as springs or is collected in wells or infiltration-galleries.

Ground-water collected directly from the soil before it has had an opportunity to stand in pipes or be exposed to the light is almost invariably free from microscopic organisms. Its passage through the soil filters them out. It usually contains an abundant supply of plant food, extracted from the organic and mineral matter of the soil and modified by bacterial action, and when the water reaches the light this food material is seized by the micro-organisms. One will recall the luxuriant aquatic vegetation at the mouth of some spring or in some watering-trough supplied with spring-water. Organisms are occasionally met with in ground-water supplies, but their presence usually indicates that some surface-water is also present. With the exception of the Schizomycetes, the number of organisms depends upon the exposure of the water to the light and air; that is, it is only as a ground-water becomes a surface-water that the microscopic organisms develop.

The table on page 76, compiled from the examinations of the Massachusetts State Board of Health, gives an idea of the organisms met with in ground-water supplies. Except in the

case of the springs, the figures represent the average of monthly observations extending over one or more years.

Spring-waters usually contain no microscopic organisms. Several exceptions are noted in the table—one at Westport, where 455 *Himantidium* were present, and one at Millis, where the water contained 180 *Chlamydomonas* per c.c. That these were accidental is shown by the fact that in 1893 five examinations of the Aqua Rex Spring showed an entire absence of organisms.

Well-waters also are ordinarily free from organisms, but in some cases *Crenothrix* grows abundantly in the tubes of driven wells. This is particularly true if the water is rich in iron and organic matter and deficient in oxygen. Wells driven in swamps are often thus affected. The tubular wells at Provincetown are an example. *Crenothrix* is sometimes found there as numerous as 20,000 per c.c. The water contains more than 0.125 parts of albuminoid ammonia per million, and the iron varies from 1.0 to 5.0 parts per million. Many similar cases might be cited. *Gallionella*, *Clonothrix*, *Chlamydothrix*, and *Cladothrix* are also observed in well-waters rich in iron and manganese. *Crenothrix* grows in tufts or in felt-like layers on the inner walls of the tubes. By the deposition of iron oxide in its gelatinous sheath it clogs up the tubes and strainers and even the sand around the well tubes with iron-rust.

Infiltration-galleries are practically elongated wells located near some stream or pond. They are similar to wells in regard to the presence of micro-organisms. Few organisms other than *Crenothrix* are found, except when surface-water gains admission.

Infiltration-basins are infiltration-galleries open to the light. The water in them is sometimes affected with algæ-growths. The infiltration-basin at Taunton, Mass., for example, has given trouble from this cause. In October 1894 there were more than 1000 *Asterionella* per c.c. present, and they were followed by a vigorous growth of *Dinobryon*. Infiltration-basins are practically open reservoirs for the storage of ground-water, a subject treated in another chapter.

MICROSCOPIC ORGANISMS IN GROUND-WATERS.  
(STANDARD UNITS PER C.C.)

No.	Locality.	Time.	Diatomaceae.	Chloro-phyceae.	Cyano-phyceae.	Fungi.*	Rhizo-poda.†	Infu-soria.†	Ro-tifera.	Total Organisms.	Zoogloea (Units).	
	SPRING-WATERS.											
I	Spring in Westport.	Apr. 21, 1894	455	0	3	0	0	0	1	459	0	
II	Aqua Rex Spring, Millis.	Aug. 27, 1894	1	180	0	0	0	0	0	181	0	
III	Craig Spring, West Springfield.	May 16, 1893	21	0	0	0	0	0	0	21	16	
IV	Spring in Ipswich.	July 27, 1892	12	0	0	0	0	0	0	12	0	
V	Spring in Pepperell.	Nov. 26, 1894	1	1	0	2	0	0	0	4	0	
VI	Massasoit Spring, West Springfield.	May 16, 1893	2	0	0	0	0	0	0	2	0	
VII	Spring in Ware.	July 17, 1893	0	0	0	0	0	1	0	1	0	
VIII	Spring in Medfield.	Aug. 31, 1894	0	0	0	0	0	0	0	0	0	
IX	Spring in Pittsfield.	Aug. 27, 1894	0	0	0	0	0	0	0	0	0	
X	Cold Spring, Plymouth.	July-Dec. 1894	0	0	0	0	0	0	0	0	0	
	WELL-WATERS.											
I	Tubular Well, Provincetown.	1894	0	0	0	3130	0	0	0	3130	50	
II	Tubular Wells, Revere.	1894	1	0	0	281	0	0	0	282	8	
III	Large Collecting Well, Marblehead.	1894	0	0	0	173	0	0	0	173	18	
IV	Tubular Wells, Hyde Park.	1893-4	2	0	0	68	0	0	0	70	7	
V	Tubular Wells, Malden.	1891-3	5	0	1	0	pr.	1	0	8	—	
VI	Tubular Wells, Lowell.	1893	0	2	0	0	0	0	0	2	—	
VII	Tubular Wells, Melrose.	1894	0	0	0	1	0	0	0	1	—	
VIII	Tubular Wells, Bradford.	1893	0	0	0	1	0	0	0	1	—	
IX	Well, Needham.	1894	0	0	0	0	0	pr.	0	0	547	
X	Well at Fitzwilliam, N. H.	1893	0	0	0	0	0	0	0	0	0	
	FILTER-GALLERIES. (Infiltration-galleries.)											
I	Filter-gallery at Reading.	1891-4	3	0	0	3506	0	2	0	3511	726	
II	Filter-gallery at Wayland.	1891	15	4	1	1706	0	3	0	1728	71	
III	Filter-gallery at Whitman.	1891	1	0	0	137	0	0	0	138	41	
IV	Filter-gallery at Watertown.	1892	pr.	0	0	217	0	0	0	217	72	
V	Filter-gallery at Framingham.	1891	1	0	0	137	0	0	0	138	41	
VI	Filter-gallery at Braintree.	1894	0	0	0	34	0	2	0	36	94	
VII	Filter-gallery at Woburn.	1891	2	0	0	0	0	0	0	2	1	
VIII	Filter-basin at Taunton.	1891-4	80	2	4	24	0	48	1	165	14	
IX	Filter-basin at Newton.	1892-4	2	1	0	15	0	pr.	0	18	13	
X	Filter-basin at Waltham.	1892	17	0	0	0	0	pr.	0	17	4	

† Protozoa.

\* Including the Schizomycetes. The organisms were chiefly Crenothrix.

**Surface-water.**—The term “surface-water” includes all collections of water upon the surface of the earth, such as lakes, reservoirs, ponds, rivers, pools and ditches.

The table on page 78 shows that surface-waters contain many more microscopic organisms than ground-waters, and that standing water contains more organisms than running water.

**River Waters.**—River waters unless draining lakes or reservoirs seldom contain large numbers of microscopic organisms, and water-supplies drawn from rivers and subjected to limited storage are not often troubled with animal or vegetable growths. This may be true even where the banks of the stream are covered with aquatic vegetation. The organisms found in streams often include a great variety of genera and of these many are likely to be sedentary forms. Their food-supply is brought to them by the water continually passing. In quiet waters there are found free-swimming forms that must go in search of their food. It is difficult to draw a sharp line between these two classes of organisms. Some are free-swimming at will or during a part of their life-history, and some free-swimming organisms are always found associated with sedentary forms. In most rivers there are some quiet pools where free-swimming forms may develop and in many streams there are dams which back up the water so as to form large reservoirs. Here luxuriant growths often occur. Thus we find that the water of the Ohio River at Louisville and elsewhere often contains so many diatoms as to have a marked influence on the filter through which the city water is passed.

In a sample of river-water, then, one is likely to find sedentary forms which have become detached, organisms which have developed in the quiet places or in tributary ponds, and spores or intermediate forms in the life-history of sedentary organisms. In streams draining large ponds or lakes the water naturally has the character of the pond- or lake-water, and organisms may be abundant.

The number of microscopic organisms found in rivers is subject to great fluctuations. If the water is rich in food.

MICROSCOPIC ORGANISMS IN SURFACE-WATERS.  
(STANDARD UNITS PER C.C.)

No.	Locality.	Time.	Diatomaceae.	Chlorophyceae.	Cyano-phyceae.	Fungi.*	Rhizo-poda.†	Infu-soria.†	Po-ctifera.	Total Organisms.	Zoogloea (Units).
RIVERS.											
I	Stony Brook, Inflow to Basin 3.	1891-2	77	23	43	38	I	9	0	101	97
II	Mill River at Taunton.	July-Sept. 1893	3	25	2	195	I	4	Dr.	109	670
III	Merrimack River at Lawrence.	1891-4	69	21	0	85	Dr.	5	Dr.	105	150
IV	Swich River.	1892	12	1	0	87	0	3	0	108	31
V	Blackstone River at Uxbridge.	1891-2	17	0	0	3	0	74	Dr.	108	304
VI	Cold Spring Brook, Inflow to Basin 2.	1891-2	45	16	2	32	Pr.	3	0	98	128
VII	Nashua River, North Branch.	1891	54	Pr.	0	12	0	0	0	77	39
VIII	Taunton River.	1891-3	13	4	2	42	0	0	0	67	810
IX	Lynde Brook, Worcester.	1891	17	1	2	13	0	0	0	35	58
X		1891	17	4	3	2	0	1	0	27	68
NATURAL PONDS.											
I	Mystic Lake.	1891-4	1917	199	Dr.	18	Dr.	172	Dr.	2306	128
II	Isamaea Pond.	1891-4	1310	103	137	1	I	12	I	1365	174
III	Horn Pond, Woburn.	1891-4	911	302	238	1	I	167	2	1592	65
IV	Fresh Pond, Cambridge.	1891-4	897	98	83	9	I	4	Dr.	1459	127
V	Wentham Lake, Salem.	1891-4	897	88	32	0	Pr.	32	Pr.	1999	52
VI	Buckmaster Pond, Norwood.	1891-4	184	83	9	2	I	0	Pr.	944	30
VII	Lake Cochituate.	1891-4	579	33	58	0	I	13	Pr.	993	66
VIII	Spot Pond, Malden.	1891-4	171	85	19	1	I	19	Pr.	290	93
IX	Lake Williams, Marlboro.	1891	170	17	66	1	I	13	Pr.	208	67
X	Gates Pond, Hudson.	1891-4	110	37	27	1	I	66	Pr.	242	38
ARTIFICIAL RESERVOIRS.											
I	Haynes Reservoir, Leominster.	1891	3103	0	0	1	0	19	I	3314	155
II	Walden Pond, Lynn.	1891-4	254	238	604	8	Pr.	397	I	1502	64
III	North Reservoir, Winchester.	1891-4	1357	35	72	1	Pr.	149	Pr.	1596	71
IV	Ludlow Reservoir, Springfield.	1891-4	594	200	90	5	2	96	2	904	103
V	Croft Reservoir, Fitchburg.	1892	691	140	10	2	4	92	2	947	42
VI	Holden Reservoir, Worcester.	1891-4	640	24	0	1	Pr.	29	I	707	76
VII	Basin 3, Boston.	1891-4	270	55	23	1	Pr.	12	Pr.	362	122
VIII	Basin 2, Boston.	1891-4	99	32	47	5	Pr.	5	Pr.	187	125
IX	Basin 4, Boston.	1891-4	80	31	3	1	Pr.	0	Pr.	120	43
X	Basin 6, Boston.	1894	55	5	0	0	I	31	2	94	20

† Protozoa.

\* Including the Schizomycetes.

material, littoral growths often develop with rapidity, while a heavy rain that increases the current of the water and the amount of scouring material that it carries may suddenly wash away the entire growth. With such conditions the number of organisms collected in a sample may be above the normal. At other times a rain may diminish the number of organisms in a sample by dilution. But the fluctuations are due chiefly to changes that take place in the growths in tributary ponds or swamps, and to the fact that rains may cause these ponds to overflow.

The table on page 78 shows that the Diatomaceæ are the organisms found most constantly in rivers. *Navicula*, *Coccone*, *Gomphonema* and other attached forms are common, but their numbers are small compared to those found in standing water. Some of the Chlorophyceæ, particularly *Conferva*, *Spirogyra*, *Draparnaldia* and other filamentous forms, are often observed. The Cyanophyceæ, except the *Oscillariæ*, seldom occur. Stony Brook, in the table, represents a stream affected by tributary ponds where Cyanophyceæ abound. *Crenothrix* is quite often reported in river-waters, but *Anthophysa* is often mistaken for it, and this may account in part for the high figures in the table. *Leptomit* sometimes occurs in foul waters. Animal forms are not common in rivers unless the water is polluted, but when this is the case there may be a succession of protozoa, algæ, rotifers, crustacea and fish downstream.

**Canal Waters.**—In the slowly running water of canals and ditches organisms sometimes develop in large numbers, but the conditions are not often such as to cause trouble in public water-supplies. The following instance, however, is worth noting:

On Sunday, July 12, 1896, it was observed by some of the residents living in the western part of the city of Lynn, Mass., that the water drawn from the service-taps had a green color. A glass of it showed a heavy green sediment when allowed to stand even for a few minutes. On the following day it became worse, and when the water was used for washing in the laundry

it was found to leave green stains on the clothes. These acted like grass-stains. Investigation showed that the stains were caused by *Raphidomonas*, and that these organisms were abundant in the city water. Examination of the four storage-reservoirs showed that they were not present there in sufficient numbers to account for the trouble. The water from one of the supply-reservoirs, Walden Pond, reaches the pumping-station by means of an open canal, tunnel, and pipe-line. It was in this open canal that the *Raphidomonas* were found. The sides of the canal were thickly covered with filamentous algæ, chiefly *Cladophora*. The water in the canal had a dark green color. When a bottle of it was held to the light it was almost opaque and was seen to be densely crowded with moving green organisms. As many as 2000 per c.c. were present. Evidently the organisms had developed among the algæ in the canal and had gradually scattered themselves out into the water from Walden Pond as it passed through the canal on its way to the city. The trouble was remedied by emptying the canal through the wasteways and cleaning the slopes to prevent later development. This is the only case on record where *Raphidomonas* has caused trouble, though the organism is often found in surface-water supplies in small numbers.

**Lakes and Reservoirs.**—All quiescent surface-waters are liable to contain microscopic organisms in considerable numbers. The water that is entirely free from them is very rare. It is scarcely possible to collect a sample of stagnant water at any season of the year without obtaining one or more forms of microscopic life. They are present not only in the mud puddles in the streets, but in large reservoirs; not only in rain barrels, but in the Great Lakes and even in the ocean. The extent and character of the growths vary greatly in different ponds and at different seasons.

As it is in ponds, lakes and reservoirs that the microscopic organisms cause the most trouble, it is these bodies of water that chiefly interest us. Before considering the organisms in this class of water-supplies it is important to know something about the physical conditions of water in ponds

and lakes. These are discussed in the following chapter. In passing, one should observe from the table that all classes of organisms, except perhaps the Schizophyceæ, are much more abundant in natural ponds and in reservoirs than in rivers.

**Filtered Water.**—Water which has been filtered, either by the method of slow sand filtration or by mechanical filtration, seldom contains many microscopic organisms. Their presence in a filter effluent generally indicates that the filtration is imperfect. In the case of mechanical filtration microscopic organisms are somewhat more likely to appear in the effluent, than in sand filters. This is apparently due in part to the use of coarser sand and a higher rate of filtration and in part to the fact that the organisms become attached to the sand-grains near the surface and are carried to the bottom of the tank during the process of washing, where they become dislodged. The presence of a few microscopic organisms in the effluent of a mechanical filter, therefore, does not necessarily indicate a very imperfect filtration.

Occasionally growths of *Crenothrix* and allied species occur in the under-drains of sand filters. They usually appear where the conditions are such that the water is deprived of part of its oxygen, or where, through leakage, ground-water, containing iron and carbonic acid in solution becomes mixed with the filtered water.

Growths of microscopic organisms often occur in filtered water when exposed in open reservoirs to the sunlight, as described in Chapter XV.

**Dr. Marsson's Investigations.**—One of the most interesting descriptions of the relation of the various classes of microscopic organisms to each other and to their environment is that given by the late Dr. Maximilian Marsson who for many years was connected with the Royal Testing Station for Water Supply and Sewage Disposal at Berlin, Germany. An excellent translation of one of Dr. Marsson's lectures, made by Emil Kuichling may be found in the *Engineering News* for Aug. 31, 1911. The lecture is entitled "The Significance of Flora and Fauna in Maintaining the Purity of Natural Waters."

**Importance of the Biological Balance.**—Although the subject of stream pollution and self-purification is not a part of the subject of this book, it is well for the reader to understand the importance of maintaining a proper balance of animal and plant life in rivers and lakes. The author believes that ultimately the great question of the permissible limit of stream pollution will be solved on this basis. Dr. Marsson's lecture above mentioned is well worth reading in this connection.

**Potamology.**—This science remains to be developed. It will include the physical, chemical and biological studies of the waters of streams, the inter-relations of the various organisms and the effect of changing environment upon them. It will do for running waters what limnology is doing for the more quiet waters of reservoirs and lakes.

## CHAPTER VII

### LIMNOLOGY

LIMNOLOGY is that branch of science that treats of lakes and ponds—their geology, their geography, their physics, their chemistry, their biology, and the relations of these to each other. This subject has taken shape only within the past twenty-five years, but already a vast number of valuable publications has appeared.

In this and the next chapters only such limnological studies as are closely related to the microscopic organisms will be considered. The most important of these are: the movements of the water, the temperature of the water at different depths, the amount of light received and transmitted by the water, and the food material of the organisms found in the water. The location of lakes, their shape, size, and depth, the source of their supply, the character of the watershed, the meteorology of the region, all have their effect upon the organisms living in the water, but they can be considered only incidentally.

**Physical Properties of Water.**—The density of water varies with its pressure, with its temperature, and with the substances dissolved in it.

Grassi gives the coefficient of compressibility of pure water as .0000503 per atmosphere at 0° C., and .0000456 at 25° C. Therefore if the density at the surface of a lake is unity, at a depth of 339 ft. (10 atmospheres) it will be 1.0005; at 678 ft. (20 atmospheres), 1.001; and at 1017 ft. (30 atmospheres), 1.0015.

Water attains its maximum density at about 4° C. or 39.2° F. Assuming its density at 4° C. to be unity, its density at other temperatures is given in the following table.

## DENSITY OF WATER AT DIFFERENT TEMPERATURES.

Temperature.		Density.	Temperature.		Density.
Centigrade.	Fahrenheit.		Centigrade.	Fahrenheit.	
0°	32.0°	.99987	18.3°	65.0°	.99859
1.6	35.0	.99996	21.1	70.0	.99802
4.0	39.2	1.00000	23.8	75.0	.99739
4.4	40.0	.99999	26.6	80.0	.99669
7.2	45.0	.99992	29.4	85.0	.99592
10.0	50.0	.99975	32.2	90.0	.99510
12.7	55.0	.99946	35.0	95.0	.99418
15.5	60.0	.99907	37.7	100.0	.99318

Water freezes at 0° C., or 32.0° F. Ice is lighter than water. It readily floats in water at 0° C.

Water has a very high specific heat. It is a poor thermal conductor. Prof. W. H. Weber \* gives its coefficient of conductivity as 0.0745.

Water is extremely mobile. This property renders it subject to displacement by mechanical agencies, such as wind and currents (mechanical convection), and permits it to become stratified according to the density of its particles.

The viscosity of water has an important influence on microscopic organisms, as it materially affects their flotation. It also affects the sedimentation of fine particles in water and even the circulation of the water itself. Viscosity varies with the temperature. It is twice as great near the freezing-point as at ordinary summer temperatures. This is shown by the table on page 85.

When water is stratified with the warmer layers above the colder, the stratification is said to be "direct." This occurs when the temperatures are above that of maximum density. When water is stratified with the colder layers above the warmer the stratification is said to be "inverse." This occurs when the temperatures are below that of maximum density. With the temperatures above 39.2° it sometimes happens in a deep lake that a colder layer of water is found above a warmer layer.

\* Vierteljahreschrift der Zürich Nat. Ges., xxiv. 252, 1879.

## VISCOSITY OF DISTILLED WATER AT DIFFERENT TEMPERATURES.

Temperature (C.)	Viscosity Coefficient (Dynes per Sq. Centimeter).	Percentage of Viscosity at 0° C.
0°	0.017780	100.0
5	0.015095	84.9
10	0.013025	73.2
15	0.011425	64.2
20	0.010015	56.3
25	0.008910	50.1
30	0.007975	44.8
35	0.007200	40.5
40	0.006535	36.8
50	0.005475	30.8
60	0.004680	26.3
70	0.004060	22.8
80	0.003560	20.0
90	0.003155	17.7
100	0.002830	15.9

This is a paradox theoretically possible, because the density of the water at any point in a lake depends upon its depth as well as its temperature. Thus water at 45° F. has a density of .99992. If this water were at a depth of 1017 ft., where the pressure is 30 atmospheres its density would be  $.99992 + .0015 = 1.00142$ , i.e., more than that of water at 39.2° F. at the surface. In nature, however, such a condition of temperatures seldom exists for a long period, and practically represents a state of unstable equilibrium. A thermal paradox may be caused also by differences in the density of different strata due to substances in solution.

Water has a slight power of diathermancy, i.e., it permits the penetration of radiant heat to a slight degree. Forel experimented on the diathermancy of water by comparing the readings of thermometers with blackened and with ordinary bulbs at a depth of 1 meter. He obtained the results found in the table on page 86.

**Lake Thermometry.**—The observation of the temperature of the water at the surface of a lake is a comparatively easy matter, but it requires an accurate thermometer and a careful observer. Where the water is smooth the thermometer-bulb

## TEMPERATURE OBSERVATIONS ILLUSTRATING DIATHERMANCY

Date.	Time of Exposure.	Temperature of Water. (Fahrenheit.)	Excess of Temperature of Black Bulb Thermometer, in Fahr. Deg.
Mar. 27, 1871....	10 hours	44.4°	10.8°
July 25, 1873....	17 "	72.0	14.0
July 26, 1873....	15 "	74.3	15.3
Aug. 1, 1873....	12 "	75.2	7.6

may be immersed just beneath the surface in an inclined position and the reading taken removing it from the water. In taking the reading one must be careful to avoid parallax by holding the thermometer exactly at right angles to the line of sight. When the water is too rough for reading directly some of the surface-water may be dipped up and the temperature of that ascertained. Thermometers with bulb immersed in a cup are prepared for this purpose. Direct observations are much to be preferred.



FIG. 35. — Weighted Case for Holding a Thermometer.

The best thermometer for general use is a "chemical thermometer," that is one with a cylindrical bulb and graduated directly on the stem. A good length is 9 inches. The most convenient range is from 20° to 120° F., and the graduations should be to the nearest half degree. If the Centigrade scale is used the range may be from 5° to 40° and the graduations to the nearest fifth of a degree. To protect against breakage the thermometer may be mounted in a wooden case as shown in Fig. 35. If weighted, this may be put inside a bottle and used to obtain sub-surface temperatures.

**Sub-surface Temperatures.**—The observation of the temperature of the water at depths below the surface is more difficult.

The simplest method of obtaining results that are in any way accurate is to enclose a weighted thermometer in a stoppered empty bottle and to lower this to the proper depth and fill it by drawing out the stopper. After allowing a sufficient time for the apparatus and thermometer to acquire the exact temperature of the water the bottle is drawn to the surface and the reading taken before the thermometer is removed from the bottle. If the bottle is of sufficient size, if it is allowed to remain down long enough, if it is drawn rapidly to the surface and the reading taken at once, the error ought not to exceed one degree Fahrenheit. This method is impracticable for lakes much deeper than 50 ft., and beyond that depth some form of deep-sea thermometer is necessary. Several forms of maximum and minimum thermometers and of self-setting thermometers have been devised. The Negretti and Zambra thermometers have been used extensively for obtaining the temperature of very deep water. Several forms of electrical thermometers have been suggested, but the thermophone invented by H. E. Warren and George C. Whipple is one that has proved of great practical value. Dr. Howard T. Barnes, of McGill University, has also devised a serviceable instrument.

**The Thermophone.**—The thermophone (see Fig. 36) is an electrical thermometer of the resistance type. It is based upon the principle that the resistance of an electrical conductor changes with its temperature and that the rate of change is different for different metals. Two resistance-coils of metals that have different electrical temperature-coefficients, as copper and German silver, are put into adjacent arms of a Wheatstone bridge and located at the place where the temperature is desired, the two coils being joined together at one end. The other extremities of the coils are connected by leading wires to the terminals of a slide-wire which forms a part of the indicator. A third leading wire extends from the junction of the two coils to a movable contact on the slide-wire, having in its circuit a telephone and a current-interrupter—the latter operated by an independent battery connection. The telephone and interrupter serve as a galvanometer to detect the presence

of a current. The slide-wire is wound around the periphery of a mahogany disk, above which there is another disk carrying a dial graduated in degrees of temperature. The movable contact which bears on the slide-wire is attached to a radial arm placed directly under the dial-hand, the two being moved

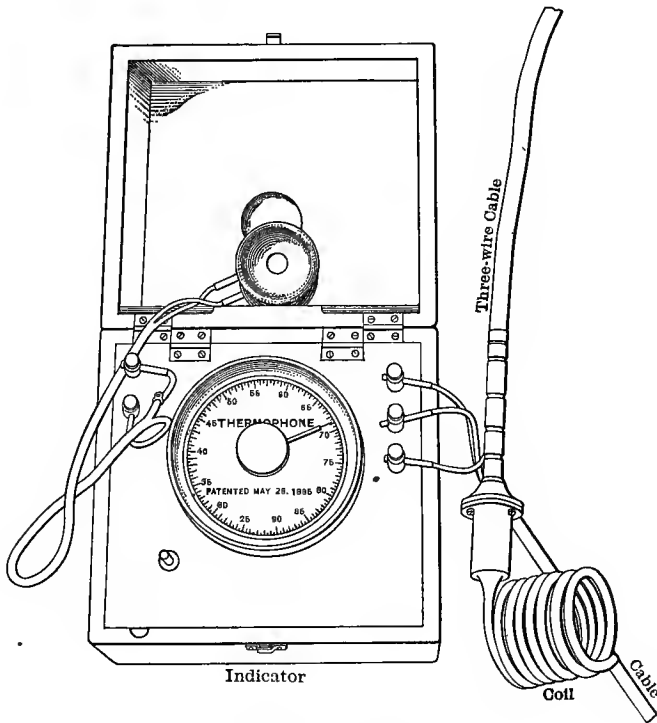

FIG. 36.—Thermophone.

together by turning an ebonite knob in the center of the dial. This indicator is enclosed in a brass case in a box that also contains the batteries. The sensitive coils are enclosed in a brass tube of small diameter which is filled with oil, hermetically sealed, and coiled into a helix. Connections with the leading wires are made in an enlargement at one end. The leading wires are three in number and are made to form a triple cable.

The temperature of the leading wires does not affect the reading of the instrument because two of them are of low resistance and are on opposite sides of the Wheatstone bridge. They neutralize each other. The third leading wire is connected with the galvanometer and does not come into the equation. The readings of the instrument are independent of pressure.

The operation of taking a reading is as follows: The coil is lowered to the depth where the temperature is desired, the three leading wires are connected to the proper binding-posts of the indicator-box, the current from the battery is turned on, the telephone is held to the ear, and the index moved back and forth over the dial. A buzzing sound will be heard in the telephone, increasing or diminishing as the index is made to approach or recede from a certain section of the dial. A point may be found at which there is perfect silence in the telephone, and at this point the hand indicates the temperature of the distant coil. With thermophones adjusted for atmospheric range, i.e., from  $-15^{\circ}$  to  $115^{\circ}$  F., readings correct to  $0.1^{\circ}$  F. may be made. With a smaller range greater sensitiveness may be obtained. It is possible to make thermophones that will read to thousandths of a degree.

Because of its accuracy, because of the ease with which the coil may be placed at any depth from the surface to the bottom of a lake, because of its extreme sensitiveness and rapidity of setting (one minute is sufficient), and because of its portability, the thermophone is better adapted than any other instrument for taking series of temperature observations in lakes at various depths. It has been used for that purpose at depths as great as 400 ft., and it was used by Prof. A. E. Burton in Greenland at much greater depths for obtaining temperatures in the crevasses of glaciers.

**Temperature Changes in a Lake.**—The general character of the temperature changes that take place in a body of water are illustrated by Fig. 37, which shows the temperatures at the surface and bottom of Lake Cochituate. The curves are based on a seven-years series of weekly observations, but some irregularities have been omitted for the sake of simplicity.

If one traces the line of surface temperatures, he will observe that during the winter the water immediately under the ice stands substantially at  $32^{\circ}$  F., although the ice itself often becomes much lower than  $32^{\circ}$  at its upper surface. As soon as the ice breaks up in the spring the temperature of the water begins to rise. This increase continues with some fluctuations until about the first of August. Cooling then begins and continues regularly through the autumn until the lake freezes in December. If this curve of surface temperature were compared with the mean temperature of the atmosphere for the same period a striking agreement would be noticed, and it

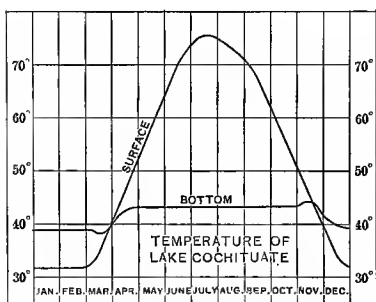

FIG. 37.

would be seen that the water temperature is the higher of the two. When the surface is frozen there is no comparison between the air and water temperatures. During the spring and early summer, when the water is warming, the water is but slightly warmer than the air,\* but during the late summer and autumn it is about  $5^{\circ}$  warmer. The surface temperature of the water fluctuates with the air temperature during the course of the day as well as on different days. The maximum is usually obtained between 2 and 4 P.M. and the minimum between 5 and 7 A.M. The daily range is seldom greater than  $5^{\circ}$ , though it may be much more. At the latitude of Boston the maximum surface temperature of the water of lakes during the summer is seldom above  $80^{\circ}$ .†

\* It must be understood that it is the mean temperature of the air during 24 hours that is referred to, and not the maximum temperature during the day-time.

† A surface temperature of  $92^{\circ}$  was observed by the author at Chestnut Hill Reservoir on Aug. 12, 1896, at 3 P.M., after a week of excessively hot weather, during which the maximum daily temperature remained above  $90^{\circ}$ , while the humidity varied from 62% to 95%. At the time of the observation the air tem-

In small shallow ponds the surface temperature follows the atmospheric temperature much more closely than in large deep lakes where the water circulates to considerable depths. In the latter the surface temperature is often below that of the mean atmospheric temperature during the early part of the summer, and occasionally during the entire summer.

Lake Cochituate is 60 ft. deep. The temperature at the bottom during the winter, when the surface is frozen, is not far from that of maximum density ( $39.2^{\circ}$  F.). The heaviest water is at the bottom; the lightest is at the top; and the intermediate layers are arranged in the order of their density. With these conditions the water is in comparatively stable equilibrium. It is *inversely* stratified. It is the period of "winter stagnation."

As soon as the ice has broken up in the spring the surface-water begins to grow warmer. Until it reaches the temperature of maximum density it grows denser as it grows warmer, and tends to sink. Thus until the water throughout the vertical has acquired the temperature of maximum density there are conditions of unstable equilibrium caused by diurnal fluctuations of temperature that result in the thorough mixing of all the water in the lake. These conditions, together with the mechanical effect of the wind, usually cause a slight temporary lowering of the bottom temperature at this season. Finally the temperature throughout the vertical becomes practically uniform, and vertical currents are easily produced by slight changes in the temperature of the water at the surface and by the mechanical effect of the wind.

This is the period of "spring circulation" or the "spring overturning." It lasts several weeks, but varies in duration

perature was  $95^{\circ}$  and the humidity 70%. The temperatures of the water below the surface were as follows:

Surface.....	92.0°	10 ft.....	76.2°
1 ft.....	91.5	15 ".....	74.0
2 ".....	89.2	20 ".....	65.7
3 ".....	85.6	25 ".....	54.5
4 ".....	80.2	27 ".....	53.1
5 ".....	79.0		

in different years. As the season advances the surface-water becomes warmer than that at the bottom, and finally the difference becomes so great that the diurnal fluctuation of surface temperature and the effect of the wind are no longer able to keep up the circulation. Consequently the bottom temperature ceases to rise, the water becomes "directly stratified," and the lake enters upon the period of "summer stagnation." During this period, which extends from April to November, the bottom temperature remains almost constant, and the water below a depth of about 25 ft. remains stagnant. In the autumn the surface cools and the water becomes stirred up to greater and greater depths, until finally the "great overturning" takes place and all the water is in circulation. At this time there is a slight increase in the bottom temperature that corresponds to the temporary lowering of the temperature in the spring. Then follows the period of "autumnal circulation," during which the surface and bottom strata have substantially the same temperature. In December the lake freezes and "winter stagnation" begins.

The use of the thermophone for obtaining series of temperatures at frequent intervals in the vertical enables one to study the temperature changes in more detail, and see how they are affected by the geography of the lake and the meteorology of the region.

**Winter Conditions.**—In a frozen lake the water in contact with the under surface of the ice stands always at 32° F. The temperature at the bottom varies with the depth and with the meteorological conditions at the time of freezing. In most lakes, and particularly in deep lakes, it stands at the point of maximum density; in shallow lakes it may be lower than that; under abnormal conditions, as referred to on page 52, it may be slightly higher. During the period of winter stagnation the bottom temperature sometimes rises very slightly on account of direct heating by the sun's rays. This is because of the diathermancy of the water. The temperatures of the water between the surface and the bottom are illustrated by Fig. 38.

The cold water is usually confined to a thin layer—seldom

more than 5 or 10 ft. thick—under the ice, and below that layer the temperature changes but little to the bottom. This is shown by the Lake Cochituate curve. This and the (abnormal) change in the curve at the bottom may be explained as follows: During the period of autumnal circulation the temperature is uniform throughout the vertical. As the weather gets colder the temperature throughout the vertical drops. Until the temperature has reached the point of maximum density the circula-

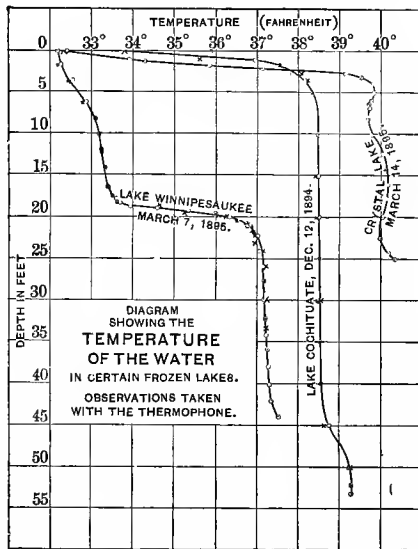

FIG. 38.—Temperature of Water in Frozen Lakes. After FitzGerald.

tion of the water through the vertical takes place in part by thermal convection; below that temperature it takes place chiefly by wind action. If the wind is not sufficiently strong to induce complete circulation the bottom temperature ceases to fall at 39.2°. Thus the bottom temperature at Lake Cochituate in December, 1894, was left at that point. Later the wind stirred the water to a depth of 45 ft., and above that depth the temperature became uniform at about 38.5°.

Freezing usually occurs on a cool, still night. The surface-

water cools and freezes before the wind has had a chance to mix it with the warmer water below. The suddenness with which a lake freezes and the intensity of the wind prior to freezing determine the depth of the layer of cold water, and the temperature of the air and the intensity of the wind previous to the time of freezing determine the temperature of the water at the bottom. The Lake Winnepesaukee curve (Fig. 38) represents the effect of a current flowing between two islands. A layer of cold water about 18 ft. thick was flowing over a quiet body of warmer water. The dividing line, at a depth of about 20 ft., was very sharply defined. The Crystal Lake curve (Fig. 38) shows abnormal conditions produced by springs at the bottom of the lake.

**Summer Conditions.**—During the summer the temperature of the water is similarly affected by meteorological conditions. After the ice has broken up, the temperature of the water at all depths rises. Above  $39.2^{\circ}$  circulation takes place chiefly by the action of the wind. If there were no wind, or if the wind were not sufficient, the temperature at the bottom would not rise above  $39.2^{\circ}$ . In very deep lakes this happens, but in most lakes the wind causes it to rise somewhat above that point. It continues to rise as long as the difference in density between the water at the surface and at the bottom does not become too great for the wind to keep up the circulation. In Lake Cochituate this difference of density is produced by a difference of about  $5^{\circ}$  in temperature. When stagnation has once begun the temperature at the bottom changes very little during the summer. It sometimes rises slightly on account of direct heating, as it does in the winter. If warm weather occurs early and suddenly in the spring the required difference of temperature between the upper and lower layers is soon obtained, and consequently the temperature at the bottom through the summer remains low. But if the season advances slowly the bottom temperature will become fixed at a higher point. In Lake Cochituate the bottom temperature varies in different years from  $42^{\circ}$  to  $45^{\circ}$ .

The temperatures of the water between the surface and

bottom during the summer may be illustrated by the two typical curves in Fig. 39. Previous to May 13, 1895, the season had progressed gradually. On that day the atmospheric temperature rose to  $90^{\circ}$  and there was little wind. These conditions produced a uniform curve. Then followed several days of cold, windy weather. The surface temperature fell and the water became stirred to a depth of about 17 ft. Below 20 ft., however, there was little change. These conditions usually continue through the summer, the upper layers becoming warmed and stratified or cooled and mixed, the lower layers remaining stagnant.

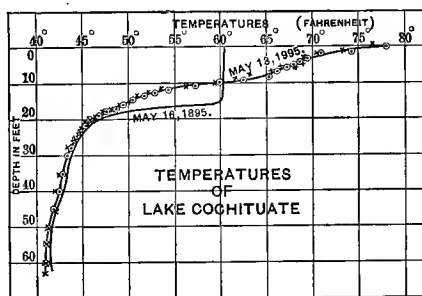

FIG. 39.

On account of the diurnal changes of the surface temperature due to alternations of day and night, sunshine and clouds, winds and calm, convection currents are almost continuously at work in the upper strata. An increasing surface temperature on a sunny day produces a condition of temporary stratification during the day, which is likely to be followed by a cooling at night which equalizes the temperatures and mixes the water by vertical convection.

**The Transition Zone.**—Figs. 40 and 41, show the results of temperature observations made at Squam Lake, N. H., during August 1913, by students taking the course in limnology at the Harvard Engineering Camp.

These diagrams show in a striking way that between the upper and lower layers there is a relatively thin layer where the

temperature changes rapidly—sometimes  $10^{\circ}$  in one vertical foot. This region has been variously named. In Germany it is called the “Sprungschicht,” in Scotland, the “Discontinuity Layer.” Dr. Birge has called it the “Thermocline.” A

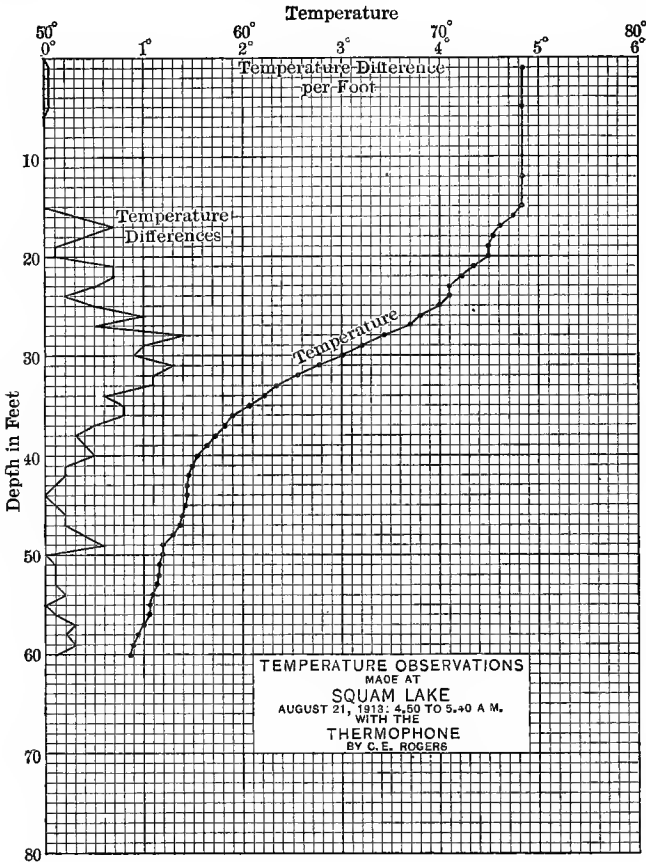

FIG. 40.

more satisfactory term, the reasons for which will appear later, seems to be the “Transition Zone.” The position of the transition zone and the rate of temperature change vary according to the depth of the lake, the intensity of the wind, and the temperature of the water above and below. Its upper boundary is

sometimes very sharp, particularly in the autumn; the lower boundary is less distinct. In the fall the position of the transition zone drops toward the bottom as circulation extends to greater and greater depths.

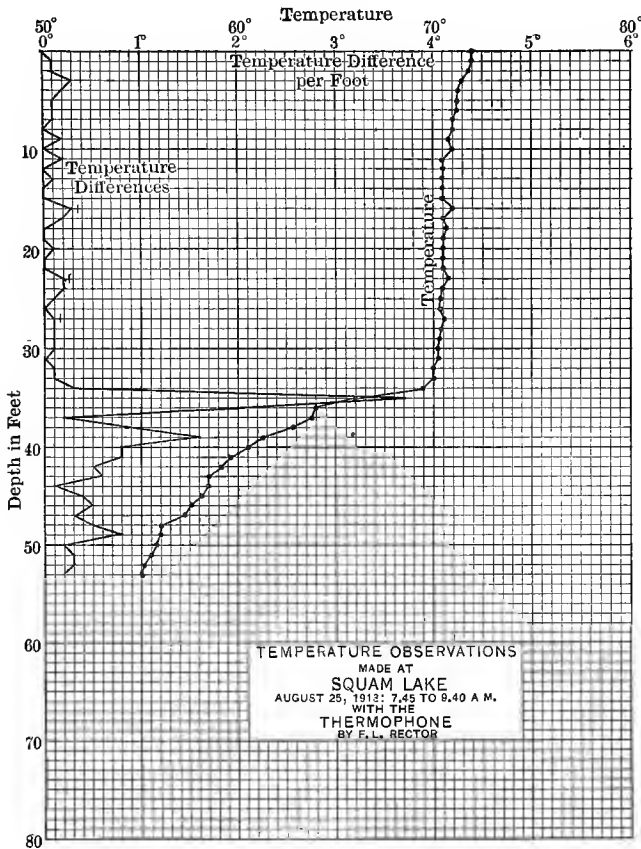

FIG. 41.

A better conception of the transition zone may be obtained from Fig. 42, which shows the cross-section of a lake as well as the temperature changes. Above the transition zone is the zone of circulation, and below it, the region of stagnation. Dr.

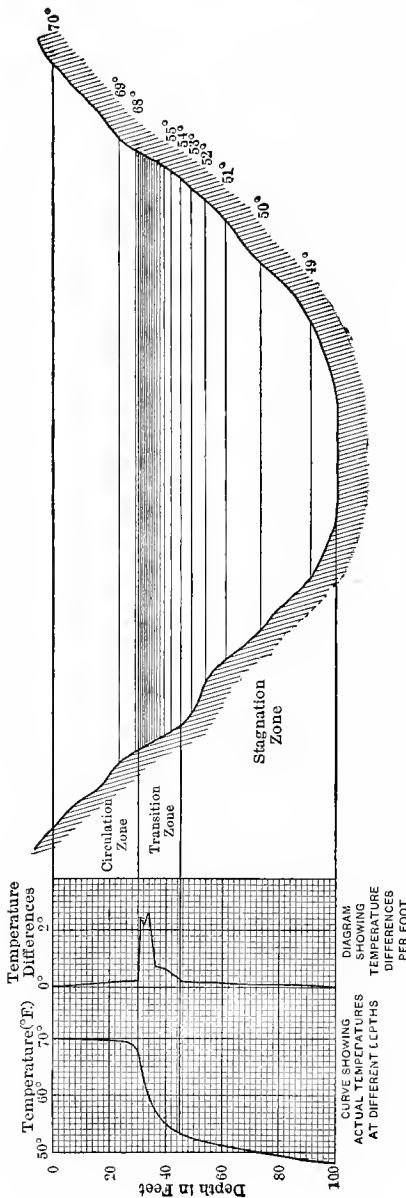

FIG. 42.—Diagram Showing Cross-section of Reservoir.

Birge calls the region above the transition zone, or thermocline, the "epilimnion," and that below it the "hypolimnion."

Within the circulation zone the water moves horizontally under the influence of the wind, and vertically by convection. It is also well aerated and almost decarbonated. In the stagnation zone, however, the horizontal currents are very slight and the vertical currents negligible. Then the condition of the dissolved gases may be reversed, oxygen being depleted or exhausted and carbonic acid increased. Hence the region of rapid temperature change is a transition layer in more ways than one, in temperature, density, viscosity, movement of the water and condition of the dissolved gases.

**Classification of Lakes According to Temperature.**—Lakes may be divided into three *types*, according to their surface

temperatures, and into three *orders*, according to their bottom temperatures. The resulting nine classes are shown in Fig. 43. On these diagrams the boundaries of the shaded areas represent the limits of the temperature fluctuations at different depths. The horizontal scale represents temperatures in Fahrenheit degrees increasing toward the right, and the vertical scale represents depth. The three types of lakes are designated as *polar*, *temperate*, and *tropical*. In lakes of the polar type the surface temperature is never above that of maximum density; in lakes of the tropical type it is never below that point;

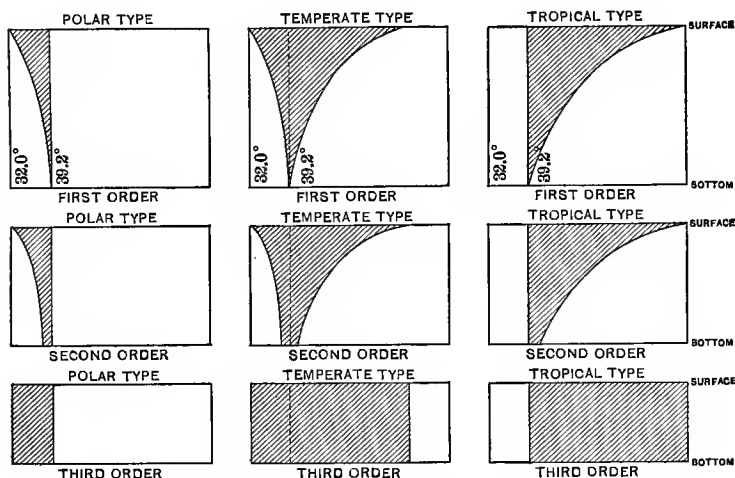

FIG. 43.—Classification of Lakes According to Temperature.

in lakes of the temperate type it is sometimes below and sometimes above it. This division into types corresponds somewhat closely with geographical location.

The three orders of lakes may be defined as follows: Lakes of the first order have bottom temperatures which are practically constant at or very near the point of maximum density; lakes of the second order have bottom temperatures which undergo annual fluctuations, but which are never very far from the point of maximum density; lakes of the third order have bottom temperatures which are seldom very far from the

surface temperatures. The division into orders corresponds in a general way to the character of the lakes; i.e., their size, contour, depth, surrounding topography, etc.

The temperature changes which take place in the nine classes of lakes according to this system of classification are exhibited in another manner in Fig. 44. These diagrams show by curves the surface and bottom temperatures for each season of the year, the dates being plotted as abscissæ, and

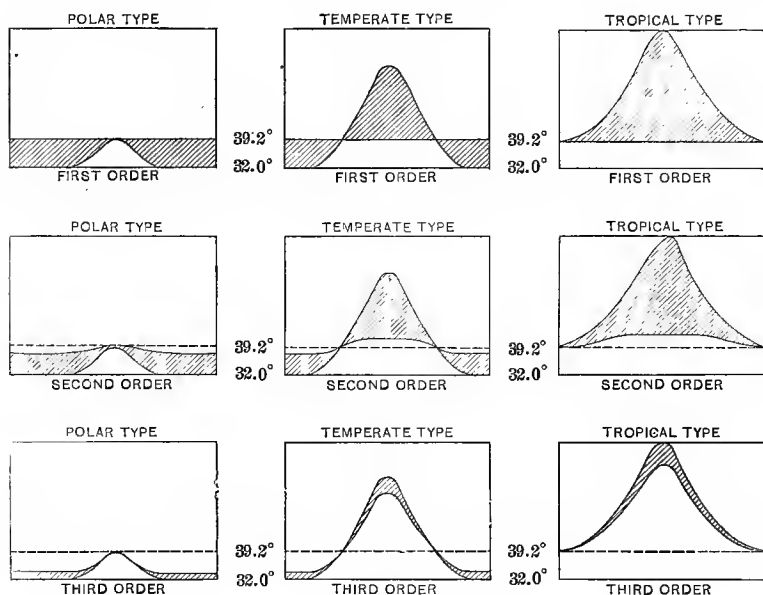

FIG. 44.—Classification of Lakes According to Temperature.

the temperatures as ordinates. The shaded areas show the difference between the surface and bottom temperatures, the wider the shaded area the greater being the difference.

A study of these diagrams brings out some interesting facts concerning the phenomena of circulation and stagnation. In Fig. 43 it will be seen that the circulation periods occur when the curve showing the temperatures at various depths becomes a vertical line; that is, when all the water has the same temperature. The stagnation periods are shown by the line being

curved, the top to the right when the warmer layers are above the colder, and to the left when the colder layers are above the warmer. In Fig. 44 the circulation periods are indicated by the surface and bottom temperature curves coinciding, and the stagnation periods by these lines being apart. The distance between the lines indicates, to a certain extent, the difference in density between the top and bottom layers, and we see that the farther apart the lines become the less likelihood there is that the water will be stirred up by the wind.

In lakes of the polar type there is but one opportunity for vertical circulation, except in the third order; namely, in the summer season, when the water approaches the temperature of maximum density. In a lake of the first order, that is, in one where the bottom temperature remains constantly at  $39.2^{\circ}$ , the circulation period would be very short indeed, if not lacking altogether. In a lake of the second order circulation might and probably would continue for a longer period. In a lake of the third order the water would be in circulation nearly all the time except when frozen. The minimum temperature limit indicated for this order, i.e.,  $32^{\circ}$  at all depths, would be possible only in very shallow bodies of water, and would simply indicate that all the water was frozen. The temperature of the ice would probably be below  $32^{\circ}$  at the surface. It is probable that very few polar lakes exist.

In lakes of the tropical type there is likewise but one period of circulation each year, except in the third order. This would occur not in summer, but in winter. In the first order this circulation period would be brief or entirely wanting; in the second it would be of longer duration; in the third order the water would be liable to be in circulation the greater part of the year. Tropical lakes are quite numerous, but observations are lacking to place them in their proper order.

Most of the lakes of the United States belong to the temperate type. In this type there are two periods of circulation and two periods of stagnation except in the third order, as we have seen illustrated in the case of Lake Cochituate. In lakes of the first order the circulation periods would be very

short or entirely wanting; in the second order the circulation periods would be of longer duration; in the third order the water would be in circulation throughout the year when the surface was not frozen. The above facts may be recapitulated in tabular form as follows:

CIRCULATION PERIODS.

	Polar Type.	Temperate Type.	Tropical Type.
First Order.	One circulation period possible, in summer, but generally none.	Two circulation periods possible, in spring and fall, but generally none.	One circulation period possible, in winter, but generally none.
Second Order.	One circulation period, in summer.	Two circulation periods, in spring and autumn.	One circulation period, in winter.
Third Order.	Circulation at all seasons, except when surface is frozen.	Circulation at all seasons, except when surface is frozen.	Circulation at all seasons.

Speaking in very general terms, one may say that lakes of the first order have no circulation, lakes of the third order have no stagnation, except in winter, and lakes of the second order have both circulation and stagnation.

In view of the comparatively few series of observations of the temperature of our lakes, the author refrains from making any classification of the lakes of the United States, but the results thus far obtained seem to indicate that the first order will include only those lakes more than about two hundred feet in depth, such, for instance, as the Great Lakes, Lake Champlain, etc.; the second order will include those with depths less than about two hundred feet, but greater than about twenty-five feet; and the third order will include those with depths less than twenty-five feet. These boundaries are only approximate, and it should be remembered that depth is not the only factor which influences the bottom temperature.

Stagnation is sometimes observed in small artificial reser-

voirs even when the depth is less than twenty feet. It is usually of short duration.

**Horizontal Currents.**—The most important horizontal currents in a lake or reservoir are those induced by the wind. As the moving air impinges upon the surface of the water it causes the water to move in the same direction. The ratio of the velocity of the surface-water to that of the air has been shown by experiment to be in the vicinity of 5 per cent in the case of a large lake like Erie. In a small lake it is less than this. Experiments made at Owasco Lake, N. Y., by Ackermann showed that the percentage which the surface-water movement was of the air movement decreased as the wind velocity increased, being about 3 per cent for a wind velocity of 5 miles per hour, and about 1 per cent for a wind velocity of 30 miles per hour. Of course the actual movement of the surface-water was greater with the higher wind velocity. According to the Owasco Lake experiments a wind velocity of 5 miles per hour would cause the surface-water to move at the rate of about 13 ft. per minute, while a 30-mile breeze would cause a water movement of 26 ft. per minute. While the direction of the surface-water movement is about the same as that of the wind it is not always so. In small lakes the surrounding topography and the varying contours of the lake bottom influence the movements of the water.

As the surface-water travels the water beneath the surface is carried along with it, but at a slower rate, the velocity decreasing with the distance below the surface. Thus at Owasco Lake, the velocity at a depth of 10 ft. was about 60 per cent of the surface velocity, and at 20 ft., 25 per cent of the surface velocity.

**Undertow Currents.**—As the water in the upper strata is driven toward the windward shore it raises the level there and the increased head causes return currents at depths below the surface. These are known as undertow currents. They are well known to exist at bathing beaches, but it is not so well known that they extend for long distances from the shore. These return currents are especially marked when the wind

drives the surface-water into a cove where the only chance for the water to return is below the surface. In large open lakes where there are jutting points the surface-water approaching a shore may be deflected and return as eddy currents at the surface.

The nature of the circulation of the water induced by the wind may be illustrated by a generalized summary of float experiments made at Squam Lake by the Harvard class in limnology in 1913. Fig. 45, shows how floats very near the surface drifted with the wind, while the deeper floats went in the opposite direction. It was found that the greater part of the return circulation was above the transition zone, but that even below the transition zone there was some movement of the water. When the bottom water is spoken of as stagnant, therefore, it must be understood that this term is not absolutely accurate.

**Shearing Plane.**—Within the zone of circulation there is a plane which divides the upper currents which follow the wind from the return currents. At this plane a float has almost no motion. The depth of the shearing plane depends to a considerable extent upon the depth of the upper boundary of the transition zone, but it is also influenced by the contours of the bottom of the lake, and by other factors. As the wind velocity increases, more and more water is carried with the surface-water in the direction of the wind, and the stagnant layers are more and more affected by the return currents.

With high winds the upper boundary of the transition zone is more distinct than with light winds.

**Effect of Horizontal Currents.**—The surface currents induced by the wind and the accompanying undertow currents have a very important influence on the lake as an environment for growths of microscopic organisms. By continually carrying surface-water downward at the windward shore oxygen is carried to the water of the underlying strata, while conversely carbonic acid may be carried upward and liberated at the surface. The plankton themselves may be carried with the moving waters, while the currents flowing over shallow areas may

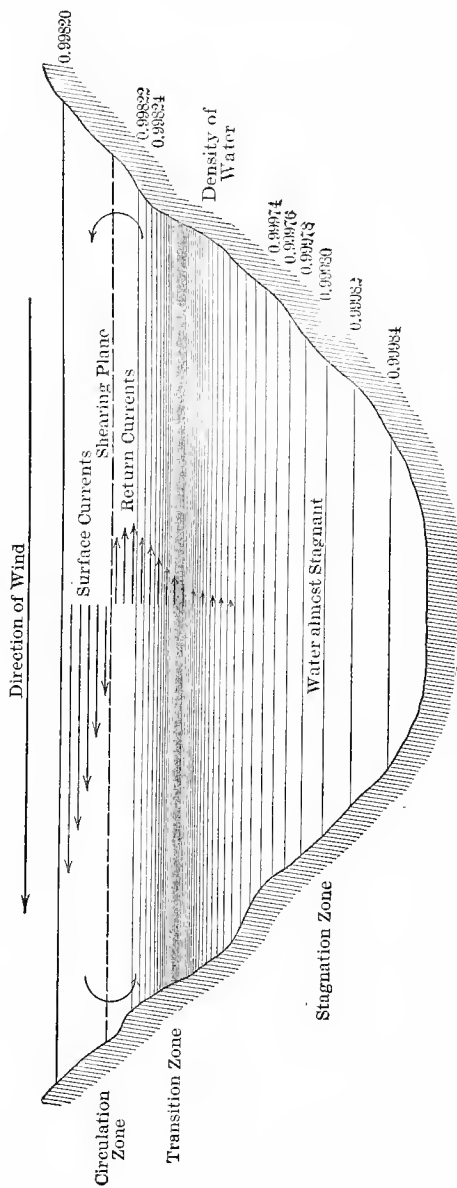

FIG. 45.—Diagram Showing Direction and Horizontal Velocity of Currents at Different Depths Induced by the Wind. (Idealized.)

pick up the spores, or seeds, of organisms and distribute them widely throughout the lake. This is the principal reason for the rapid seeding of a reservoir. It will be shown later that certain organisms tend to concentrate in the transition zone just below the region of the actively circulating water.

**Seiches.**—After a strong wind has been blowing in one direction for a considerable time and then subsides, the water which has been piled up at the windward end falls to and below its normal level. This is accompanied by a rising of the water at the lee end of the lake. Then the water on the lee falls, while that on the windward rises. These synchronous risings and fallings of the water give rise to the phenomenon known as the “seiche” (pronounced sāsh). The amplitude of the seiche vibrations may vary all the way from a few hundredths of an inch to several feet, but it is only in very large lakes that the latter are observed. The time of oscillation is fairly constant for any particular lake. One authority has given the following formula, which, while not accurate, illustrates the nature of the factors involved.

$$t = \frac{2l}{3600\sqrt{dg}},$$

where  $t$  = time of oscillation in hours.

$l$  = length of the lake (or width in the case of transverse seiches) in feet.

$d$  = mean depth in feet of lake along the axis of observation.

$g$  = acceleration of gravity (32.16).

This formula applied to Lake Erie gave a calculated seiche period of 14.4 hours, while the observed periods have ranged from 14 to 16 hours.

Other causes than the wind may produce seiches, such as sudden and unequal changes of barometric pressure at opposite ends of a lake, and sudden rainfalls at one end of a lake. Seiches are of less importance to the sanitary engineer than are the horizontal currents that accompany them.

**Transmission of Light by Water.**—The amount of light received by the micro-organisms in a lake depends upon the intensity of the light at the surface of the water and upon the extent to which the light is transmitted by the water. The transmission of light by water varies chiefly with the amount of dissolved and suspended matter that it contains. The former affects its coefficient of absorption; the latter acts as a screen to shut out the light. In studying the penetration of light into a body of water it is necessary to take account of its color and its turbidity. Dr. H. C. Jones says that salts like the chlorides of calcium and magnesium which combine with large amounts of water in aqueous solution diminish the absorption of light.

**Color of Water.**—Some surface-waters are colorless, but in most ponds and lakes the water has a more or less pronounced brownish color. This may be so slight as to be hardly perceptible, or it may be as dark as that of weak tea. It is darkest in water draining from swamps, and the color of the water in any pond or stream bears a close relation to the amount of swamp-land upon the tributary watershed. The surface water in granite regions is generally darker than in regions of shale or slate.

The color is due to dissolved substances of vegetable origin extracted from leaves, peaty matter, etc. It is quite as harmless as tea. The exact chemical nature of the coloring matter is not known. It is complex in composition. Tannins, glucosides, and their derivatives are doubtless present. The color of a water usually bears a close relation to the albuminoid ammonia present. Carbon, however, is the important element in its composition. The color of a water varies very closely with the "oxygen consumed." Iron is present, and its amount varies with the depth of the color. In some waters iron alone imparts a high color, but in peaty waters it plays a subsidiary part. Manganese may also play a part.

The color of a water is usually stated in figures based on comparisons made with some arbitrary standard, the figures increasing with the depth of the color. The Platinum-Cobalt Standard, the Natural Water Standard, and the Nessler Standard

are those which have been most commonly used. The first is now the accepted standard. Comparisons of the water with the standard may be made in tall glass tubes or in a colorimeter such as that used at the Boston Water Works.\*

For field-work a color comparator, by which the color of the water is compared with disks of colored glass, is very useful. The water is placed in a metallic tube with glass ends and its color compared with a second tube containing distilled water and with one end covered with one or more of the glass disks. This apparatus, devised for the United States Geological

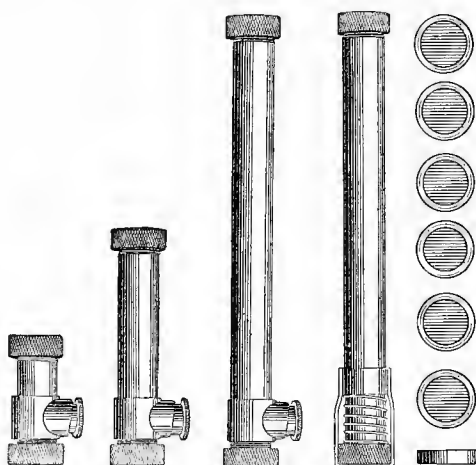

FIG. 46.—U. S. Geological Survey Apparatus for Measuring the Color of Water.

Survey by Dr. Allen Hazen and the author, is illustrated in Fig. 46.

The amount of color in the water collected from a watershed has a seasonal variation. This may be illustrated by the color of the water in Cold Spring Brook, at the head of the Ashland Reservoir of the Boston Metropolitan Supply. This brook is fed in part from several large swamps. The figures given are based on weekly observations.

\* See FitzGerald and Foss, "On the Color of Water," *Jour. Frank. Inst.*, Dec. 1894.

## AVERAGE COLOR OF WATER IN COLD SPRING BROOK, 1894.

Jan.	Feb.	Mar.	Apr.	May.	June.	July.	Aug.	Sept.	Oct.	Nov.	Dec.	Av.
99	88	.96	93	142	159	98	75	60	69	144	120	104

There are usually two well-defined maxima, one in May or June and one in November or December. In the winter and early spring the color of the water is low because of dilution by the melted snow. As the yield of the watershed diminishes the color increases until the water standing in the swamp areas ceases to be discharged into the stream. During the summer the water in the swamps is high-colored, but its effect is not felt in the stream until the swamps overflow in the fall. Heavy rains during the summer may cause the swamps to discharge and increase the color of the water in the reservoirs below. It has been found that in general the color of the water delivered from any watershed bears a close relation to the rainfall. In some localities this is more noticeable than in others. In Massapequa Pond of the Brooklyn water-supply the color varies greatly from week to week, and the fluctuations are almost exactly proportional to the rainfall. In large bodies of water the seasonal fluctuations in color are less pronounced.

The hue of the water in the autumn is somewhat different from that in the spring. The fresh-fallen leaves and vegetable matter give a greenish-brown color that is quite different from the reddish-brown color produced from old peat.

**Bleaching.**—When colored water is exposed to the light it bleaches. A series of experiments made at the Boston Water Works by exposing bottles of high-colored water to direct sunlight for known periods showed that during 100 hours of bright sunlight the color was reduced about 20 per cent, and that with sufficient exposure all the color might be removed. The bleaching action was found to be independent of temperature. Sedimentation had but little influence on it. It was dependent entirely upon the amount of sunlight. The percentage reduction was independent of the original color of the water.

This bleaching action takes place in reservoirs where colored water is stored. Stearns has stated that in an unused reservoir 20 ft. deep the color of the water decreased from

40 to 10 in six months. In the Ashland reservoir referred to, the average color of the water in the influent stream for the year 1894 was 104. For the same year the average color of the water at the lower end of the basin was 71. It should be stated that this difference is not due wholly to bleaching action. The amount of coloring-matter entering the reservoir is not correctly shown by the figure 104, for the reason that the quantity of water flowing in the stream is not uniform. It is greatest in the spring when the melting snows give the water a color lower than the average. Furthermore, some colorless rain-water and ground-water enters the basin. There is also a loss of high-colored water at the wasteway at a season when the color of the water is above the average. It is a difficult matter to ascertain just the amount of bleaching action that takes place in a reservoir through which water is constantly flowing.

Experiments (by the author) made by exposing bottles of colored water at various depths in reservoirs have shown that the bleaching action that takes place at the surface of a reservoir is considerable, sometimes 50 per cent in a month. It decreases rapidly with increasing depth, and the rapidity with which it decreases below the surface depends upon the color of the water in the reservoir, as the following table will show:

EXPERIMENTS TO DETERMINE THE AMOUNT OF BLEACHING ACTION AT DIFFERENT DEPTHS.

	Expt. No. 1.	Expt. No. 2.	Expt. No. 3.
Color of water in reservoir.....	20	37	44
Time of exposure.....	Aug. 6-Sept. 4	May 5-June 4	July 2-Aug. 3.
Color of water exposed.....	175	272	170
Percentage reduction of color:			
At depth of 0.0 ft.....	....	52%	41%
“ “ “ 0.5 “.....	65%	29%	20%
“ “ “ 1.25 “.....	32%	8%	12%
“ “ “ 2.5 “.....	21%	4%	4%
“ “ “ 5.0 “.....	14%	4%	3%
“ “ “ 7.5 “.....	3%	0%	0%
“ “ “ 10.0 “.....	1%	0%	0%
“ “ “ 15.0 “.....	0%	0%	0%
Dark room.....	0%	0%	0%

From these and many similar experiments it has been found possible to calculate the extent of the bleaching action that takes place in any reservoir. The results agree closely with the observed color-readings of the water in the reservoir. The experiments also bear directly upon the penetration of light into the water of a reservoir.

**Turbidity of Water.**—The turbidity of water is due to the presence of particles of matter in suspension, such as clay, silt, finely divided organic matter, and microscopic organisms.

There are three principal methods used for measuring turbidity which give fairly comparable results. These are: 1, Comparison with silica standards. 2, Platinum-wire method. 3, Turbidimeter method. In all cases the results of the observations are expressed in numbers which correspond to turbidities produced by equivalent amounts of finely-divided silica in parts per million.

The standard of turbidity has been defined by the U. S. Geological Survey as follows:

“The standard of turbidity shall be a water which contains 100 parts of silica per million in such a state of fineness that a bright platinum wire 1 millimeter in diameter can just be seen when the center of the wire is 100 millimeters below the surface of the water and the eye of the observer is 1.2 meters above the wire, the observation being made in the middle of the day, in the open air, but not in sunlight, and in a vessel so large that the sides do not shut out the light so as to influence the results. The turbidity of such water shall be 100.”

The most convenient method for limnological field-work is the platinum-wire method. This method requires a rod with platinum wire of a diameter of one mm. or 0.04 inch, inserted in it about one inch from the end of the rod and projecting from it at least one inch at a right angle. Near the end of the rod, at a distance of 1.2 meters (about four feet) from the platinum wire, a wire ring is placed directly above the wire, through which, with his eye directly above the ring, the observer looks downward in making the examination. The rod is graduated as follows:

The graduation mark of 100 is placed on the rod at a distance of 100 mm. from the center of the wire. Other graduations are made according to the table on p. 113, which is based on the best obtainable data and in which the distances are intended to be such that when the water is diluted the turbidity reading will decrease in the same proportion as the percentage of the original water in the mixture. These graduations are those used to construct what is known as the U. S. Geological Survey Turbidity Rod of 1902. (See Fig. 47.)

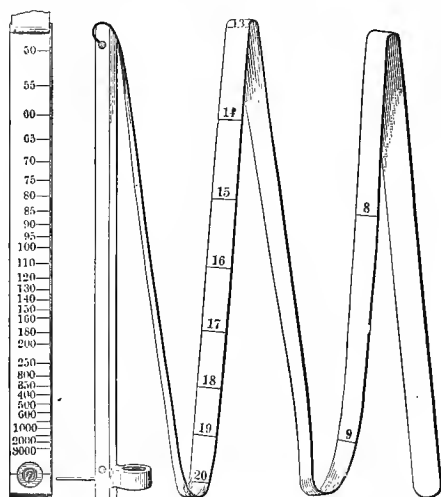

FIG. 47.—U. S. Geological Survey Turbidity Rod.

*Procedure.*—"Push the rod vertically down into the water as far as the wire can be seen, and then read the level of the surface of the water on the graduated scale. This will indicate the turbidity."

The following precautions should be taken to insure correct results:

"Observations should be made in the open air, preferably in the middle of the day and not in direct sunlight. The wire should be kept bright and clean. If for any reason observations cannot be made directly under natural conditions a pail or tank may be filled with water and the observation taken in that,

but in this case care should be taken that the water is thoroughly stirred before the observation is made, and no vessel should be used for this purpose unless its diameter is at least twice as great as the depth to which the wire is immersed. Waters which have a turbidity above 500 should be diluted with clear water, before the observations are made, but in case this is done the degree of dilution used should be stated and form a part of the report."

## GRADUATION OF TURBIDITY ROD

Turbidity, Parts per Million.	Vanishing Depth of Wire, mm.	Turbidity, Parts per Million.	Vanishing Depth of Wire, mm.	Turbidity, Parts per Million.	Vanishing Depth of Wire, mm.
7	1095	28	314	120	86
8	971	30	296	130	81
9	873	35	257	140	76
10	794	40	228	150	72
11	729	45	205	160	68.7
12	674	50	187	180	62.4
13	627	55	171	200	57.4
14	587	60	158	250	49.1
15	551	65	147	300	43.2
16	520	70	138	350	38.8
17	493	75	130	400	35.4
18	468	80	122	500	30.9
19	446	85	116	600	27.7
20	426	90	110	800	23.4
22	391	95	105	1000	20.9
24	361	100	100	1500	17.1
26	336	110	93	2000	14.8
				3000	12.1

For very clear waters the use of a black-and-white disk, as suggested later, will be found more satisfactory than that of the platinum wire.

**Transparency of Water.**—The transparency of water profoundly influences the intensity of light at different depths and hence has a marked effect on the growth of algæ. To compare extreme cases we observe that when very clear waters, such as ground-waters, are exposed to the light in open reservoirs algæ grow abundantly, but that plant life is very meager in the water and along the shores of the silt-laden streams of the Middle West, such as the Mississippi and the Ohio rivers.

Some light is absorbed by all waters, even distilled water, but the amount of light absorbed decreases as the suspended matter held by the water increases. As muddy waters become clarified on standing the growths of organisms tend to increase.

The most complete studies of the transparency of large bodies of water were those made by Forel and others in Switzerland. Three methods of experiment were employed. The first was that of the visibility of plates. This method, used by Secchi in 1865 in determining the transparency of the water in the Mediterranean Sea, consisted of lowering a white disk (20 cm. in diameter) into the water and noting the depth at which it disappeared from view, and then raising it and noting the point at which it reappeared. The mean of these two depths was called the limit of visibility. The second method, known as that of the Genevan Commission, was similar to the first, but instead of a white disk an incandescent lamp was lowered into the water. This light when seen through the water from above presented an appearance similar to that of a street-lamp in a fog; that is, there was a bright spot surrounded by a halo of diffused light. When the light was lowered into the water the bright spot first disappeared from view. The depth of this point was noted as the "limit of clear vision." Finally the diffused light disappeared, and the depth of this point was called the "limit of diffused light." Both these methods were useful only in comparing the relative transparency of different waters or of the same water at different times. In order to get an idea of the intensity of light at different depths a photographic method was used. Sheets of sensitized albumen paper were mounted in a frame in such a way that half of the sheet was covered with a black screen, while the other half was exposed. A series of these papers was attached to a rope and lowered into the water; they were equidistant and so supported that they assumed a horizontal position in the water. They were placed in position in the night and allowed to remain 24 hours. On the next night they were drawn up and placed in a toning-bath. A comparison of prints made at different depths enabled the observer to determine the depth at which the light

ceased to affect the paper and to obtain an idea of the relative intensity of the light at different depths. To assist in this comparison an arbitrary scale was made by exposing sheets of the same paper to bright sunlight for different lengths of time.

The results of the experiments are given by Forel as follows:

In Lake Geneva the limit of visibility of a white disk 20 cm. in diameter was 21 m. The limit of clear vision of a 7-candle-power incandescent lamp was 40 m.; the limit of diffused light was about 90 m. The depth at which the light ceased to affect the photographic paper was 100 m., when the paper was sensitized with chloride of silver, and about 200 m. when sensitized with iodobromide of silver. These depths were less in summer than in winter on account of the increased turbidity of the water. The transparency of the water in other lakes, as shown by the limit of visibility of a white disk, is cited as follows: Lake Tahoe, 33 m.; La Mer des Antilles, 50 m.; Lac Lucal, 60 m.; Mediterranean Sea, 42.5 m.; Pacific Ocean, 59 m. It should be remembered that these are all comparatively clear and light-colored waters, and that in them the light penetrates to far greater depth than in turbid and colored water. For example, in Chestnut Hill reservoir, a disk lowered into the water at a time when the color was 92 disappeared from view at a depth of six feet.

The author's experiments have shown that the limit of visibility may be determined most accurately by using a disk about 8 inches in diameter, divided into quadrants painted alternately black and white like the target of a level-rod, and looking vertically down upon it through a water-telescope



FIG. 48.—Disk for Comparing the Transparencies of the Water in Different Lakes.

provided with a suitable sunshade. It has been found that the limit of visibility obtained in this manner bears a close relation to the turbidity of the water as determined by a turbidimeter. It also varies with the color of the water, but the relation has not been carefully worked out.

**Absorption of Light by Water.**—The absorption of light by distilled water is said to vary with the temperature. The following coefficients are given by Wild as the result of laboratory experiments. It seems probable that the figures are too low.

Temperature.	Intensity of Light after passing through 1 dm. of Distilled Water.
24.4° C.	0.9179
17.0	0.93968
6.2	0.94769

The coefficient of absorption of light by colored water is quite unknown.

The reduction of light in passing downward through a body of water is supposed to follow the law that as the depth increases arithmetically the intensity of the light decreases geometrically. For example, if the intensity of the light falling upon the surface of a pond is represented by 1, and if  $\frac{1}{4}$  of the light is absorbed by the first foot of water (some colored waters absorb even more than this), then the intensity of light at the depth of 1 ft. will be  $\frac{3}{4}$ ; the second foot of water will absorb  $\frac{1}{4}$  of  $\frac{3}{4}$ , and the intensity at the depth of 2 ft. be  $\frac{9}{16}$ ; and so on. At this rate of decrease the intensity of light at a depth of 10 ft. will be only about 5 per cent of that at the surface.

Dr. Birge, who has made extensive studies of Lake Mendota, says that at a depth of one meter the solar energy varies in different lakes from 2 per cent to 20 per cent of that at the same surface.

There are few accurate data extant regarding the quality of the light at different depths, but theory would lead us to infer that in passing downward from the surface to the bottom of a lake the light varies considerably in character. The red and yellow rays are most readily absorbed by the water.

## CHAPTER VIII

### DISSOLVED GASES AND THEIR RELATIONS TO THE MICROSCOPIC ORGANISMS

THE gases dissolved in water exert such an important influence on the growth of the microscopic organisms that they deserve consideration in a special chapter.

**Photo-synthesis.**—Most of the organisms which are of interest to the water-supply specialist belong to the vegetable kingdom. Algæ may be most simply defined as microscopic plants the cells of which contain chlorophyll. By virtue of this substance they have that power of food building by which water and carbonic dioxide are united to form starch and other carbohydrates, energy for the plant thus being stored up. This process, which is known as photo-synthesis, can take place only in the light. In lakes therefore it is confined to the strata relatively near the surface. In turbid water it is limited to depths of a few inches, but in very clear waters it may take place at depths of 25 ft. or more, although at these depths its activity is slight. In photo-synthesis carbonic acid, by which term we mean carbon dioxide, is taken in while oxygen is given out.

**Respiration.**—Another phase of the life process is summed up in the word respiration, which is common to both animals and plants. By it oxygen is taken in and carbonic acid given out, the released energy appearing as heat and work in the cells. Unlike photo-synthesis the process of respiration goes on in the dark as well as in the light. In the light, however, the respiration of green plants may be masked so far as gas relations are concerned by the greater effects of photo-synthesis. Animal organisms, such as the protoza, rotifers and crustacea, and the

fungi, which contain no chlorophyll, do not have the photosynthetic power of food building and hence must consume food already prepared.

**Decomposition.**—Bacteria live upon organic matter, taking in oxygen and giving out carbonic acid. In the absence of dissolved oxygen gas in water they take their oxygen from the organic matter itself, that is they decompose it, giving out not only carbonic acid but also carbon monoxide, methane and other gases. This process has been sometimes called anaerobic respiration, that is respiration without air. It is also known as putrefaction. Decomposition takes place at the bottom of deep lakes where the water lies stagnant for long periods—hence in the stagnant layers there is always a tendency for dissolved oxygen to become depleted and for carbonic acid to increase in amount.

**Determination of Dissolved Oxygen.**—The following description of the method of ascertaining the amount of dissolved oxygen in water is taken from the Report of the Committee on Standard Methods of Water Analysis of the American Public Health Association.

There are three methods in use for the determination of atmospheric oxygen dissolved in water, viz., those of Winkler, Thresh, and Levy. Each of these methods has its own particular field of usefulness. All are capable of giving sufficiently accurate results.

The Winkler method is in the most common use in this country, and possesses the advantage of requiring only simple and not readily breakable apparatus. It is therefore recommended as the standard method, and is here described.

The method of Thresh is perhaps slightly more accurate than the Winkler method, but the apparatus is not so well adapted to field work. For certain purposes, however, as, for example, the determination of dissolved oxygen before and after incubation, it is more practical than the Winkler method because the apparatus allows the taking of representative samples direct from bottles or other containers.

What is true of the disadvantages of the Thresh method

is also true to a great degree of the Levy method. With both of these methods the samples are taken in a special stoppered, separatory funnel.

**Winkler Method.**—*Reagents.*—1. Manganous sulphate solution: Dissolve 48 grams of manganous sulphate in 100 c.c. of distilled water.

2. Solution of sodium hydrate and potassium iodide: Dissolve 360 grams of sodium hydrate and 100 grams of potassium iodide in one liter of distilled water.

3. Sulphuric acid. Specific gravity 1.4 (dilution 1:1).

4. Sodium thiosulphate solution. Dissolve 6.2 grams of chemically pure recrystallized sodium thiosulphate in one liter of distilled water. This gives an  $\frac{N}{40}$  solution each c.c. of which

is equivalent to 0.2 mg. of oxygen or 0.1395 c.c. of oxygen at 0° C. and 760 mm. pressure. Inasmuch as this solution is not permanent it should be standardized occasionally against an  $\frac{N}{40}$  solution of potassium bichromate as described in almost any work on volumetric analysis. The keeping qualities of the thiosulphate solution are improved by adding to each liter 5 c.c. of chloroform and 1.5 grams of ammonium carbonate before making up to the prescribed volume.

5. Starch solution. Mix a small amount of clean starch with cold water until it becomes a thin paste, stir this into 150 to 200 times its weight of boiling water. Boil for a few minutes, then sterilize. It may be preserved by adding a few drops of chloroform.

**Collection of the Sample.**—The sample shall be collected with extreme care in order to avoid the entrainment or absorption of any oxygen from the atmosphere. The sample bottle shall be preferably a glass stoppered bottle which has a narrow neck and which holds at least 250 c.c. The exact capacity of the bottle shall be determined and for convenient reference this may be scratched upon the glass with a diamond.

If the sample is to be collected from a tap the water shall be made to enter the bottle through a glass or rubber tube which

reaches to the bottom of the bottle, the water being allowed to overflow for several minutes, after which the glass stopper is carefully replaced so that no bubble of air is caught beneath it.

If the sample is to be collected from the surface of a pond or tank two bottles shall be used, the ordinary sample bottle and a second bottle of four times the capacity. Both bottles shall be provided with temporary stoppers of double perforation and in both cases a glass tube shall extend through one hole of the stopper to the bottom of the bottle and a short glass tube shall enter the other hole of the stopper but not project into the bottle. The short tube of the sample bottle shall be connected with the long tube of the larger bottle. In collecting the sample the sample bottle shall be immersed in the water and suction applied to the short tube of the large bottle and enough water drawn through the hole to fill the large bottle. In this way the water in the smaller bottle will be changed several times and a fair sample secured.

If the sample is to be taken at a depth below the surface both bottles may be connected, lowered to the desired depth, and if the smaller bottle is placed beneath the larger one the water will enter the small bottle and pass from that into the larger bottle, the air escaping from the short tube of the large bottle. As soon as the small bottle has been filled remove the temporary stopper and insert the permanent glass stopper using care not to entrain any bubbles of air.

*Procedure.*—Remove the stopper from the bottle and add 2 c.c. of the manganous sulphate solution and 2 c.c. of the sodium hydrate potassium iodide solution delivering both of these solutions beneath the surface of the liquid by means of a pipette. Replace the stopper and mix the contents of the bottle by shaking. Allow the precipitate to settle. Remove the stopper add about 2 c.c. of sulphuric acid and mix thoroughly. Up to this point the procedure shall be carried on in the field but after the sulphuric acid has been added and the stopper replaced there is no further change and the rest of the operation may be conducted at leisure. For accurate work there are a number of corrections necessary to be made, but in

actual practice it is seldom necessary to take them into account as they are ordinarily much less than the errors of sampling.

Rinse the contents of the bottle into a flask, titrate with  $\frac{N}{40}$  solution of sodium thiosulphate using a few c.c. of the starch solution toward the end of the titration. Do not add the starch until the color has become a faint yellow; titrate until the blue color disappears. If nitrates be present, correction must be made.

*Calculation of Results.*—The standard method of expressing results shall be by parts per million of oxygen by weight.

It is sometimes convenient to know the number of c.c. of the gas per liter at  $0^{\circ}$  C. temperature and 760 mm. pressure and also to know the percentage which the amount of gas present is of the maximum amount capable of being dissolved by distilled water at the same temperature and pressure. All three methods of calculation are therefore here given.

$$\text{Oxygen in parts per million} = \frac{0.0002N \times 1,000,000}{V} = \frac{200N}{V}$$

$$\text{Oxygen in c.c. per liter} = \frac{0.1395N \times 1000}{V} = \frac{139.5N}{V}$$

$$\text{Oxygen in per cent of saturation} = \frac{200N \times 100}{V \times O} = \frac{20000N}{VO}$$

Where  $N$  = number of c.c. of  $\frac{N}{40}$  thiosulphate solution.

$V$  = capacity of the bottle in c.c. less the volume of the manganous sulphate and potassium iodide solution added (i.e., less four c.c.).

$O$  = the amount of oxygen in parts per million in water saturated at the same temperature and pressure.

**Solubility of Dissolved Oxygen.**—The solubility of dissolved oxygen in fresh water varies with the temperature as shown by the following table. These figures are based upon the normal pressure that exists at sea-level, i.e. 760 mm. For elevations above the sea 1 per cent should be deducted for

every 270 ft. of elevation. In comparing results expressed in parts per million by weight, i.e., milligrams per liter, it is convenient to note that 1 c.c. of oxygen, at normal temperature and pressure weighs 1.4291 mg.

DISSOLVED OXYGEN IN WATER SATURATED WITH AIR AT  
DIFFERENT TEMPERATURES.

Temp.	Parts per Million.	Cubic Centimeters per liter, (at 0° C. and 760 mm.)	Temp.	Parts per Million.	Cubic Centimeters per liter, (at 0° C. and 760 mm.)
0	14.70	10.29	16	9.94	6.95
1	14.28	9.99	17	9.75	6.83
2	13.88	9.70	18	9.56	6.70
3	13.50	9.44	19	9.37	6.56
4	13.14	9.20	20	9.19	6.44
5	12.80	8.95	21	9.01	6.32
6	12.47	8.72	22	8.84	6.19
7	12.16	8.50	23	8.67	6.07
8	11.86	8.30	24	8.51	5.96
9	11.58	8.10	25	8.35	5.85
10	11.31	7.92	26	8.19	5.74
11	11.07	7.75	27	8.03	5.62
12	10.80	7.55	28	7.88	5.53
13	10.57	7.38	29	7.74	5.42
14	10.35	7.24	30	7.60	5.33
15	10.14	7.09			

**Determination of Carbonic Acid.**—The following description of the method of ascertaining the amount of dissolved carbonic acid is taken from the Report of the Committee on Standard Methods of Water Analysis of the American Public Health Association.

Carbonic acid may exist in water in three forms, free carbonic acid, bicarbonate and carbonate. One-half the carbonic acid as bicarbonate is known as the "half bound carbonic acid." The carbonic acid of carbonate plus half that of bicarbonate is known as the "bound carbonic acid."

## FREE CARBONIC ACID

*Reagents.*—Standard  $\frac{N}{22}$  solution of sodium carbonate.

Dissolve 2.41 grams of dry sodium carbonate in 1 liter of distilled water which has been boiled and cooled in an atmosphere free from carbonic acid. Preserve this solution in bottles of resistant glass, protected from the air by tubes filled with soda-lime. One c.c. equals 1 mg. of  $\text{CO}_2$ .

*Procedure.*—Measure 100 c.c. of the sample into a tall narrow vessel, preferably a 100 c.c. nessler tube, and titrate rapidly with the  $\frac{N}{22}$  sodium carbonate solution, stirring gently until a faint but permanent pink color is produced by phenolphthalein.

The number of c.c.  $\frac{N}{22}$  sodium carbonate solution used in titrating 100 c.c. of water, multiplied by 10, gives the parts per million of free carbonic acid as  $\text{CO}_2$ .

Owing to the ease with which free carbonic acid escapes from water, particularly when present in considerable quantities, it is highly desirable that a special sample should be collected for this determination, which should preferably be made on the ground. If the analysis cannot be made on the ground, approximate results from water not high in free carbonic acid may be obtained from samples collected in bottles which are completely filled so as to leave no air-space under the stopper.

BICARBONATE ( $\text{HCO}_3$ ), CARBONIC ACID AS BICARBONATE ( $\text{CO}_2$ )  
AND HALF BOUND CARBONIC ACID

When a water is acid to phenolphthalein these three forms are computed as follows, from the alkalinity expressed in terms of calcium carbonate.

Bicarbonate ( $\text{HCO}_3$ ) = 1.22 times the alkalinity.

Carbonic acid ( $\text{CO}_2$ ) as bicarbonate = 0.88 times the alkalinity.

Half bound carbonic acid = 0.44 times the alkalinity.

When the water is alkaline to phenolphthalein, bicarbonates are present only when this alkalinity is less than one-half that by methyl red or erythrosine. Then the bicarbonate alkalinity is equal to the total alkalinity by methyl red or erythrosine minus twice the alkalinity by phenolphthalein. When this difference is expressed in terms of calcium carbonate, the bicarbonate, carbonic acid as bicarbonate, and half-bound carbonic acid are determined from it by the factors given above.

CARBONATE ( $\text{CO}_3$ ), CARBONIC ACID AS CARBONATE ( $\text{CO}_2$ ), AND  
BOUND CARBONIC ACID

Carbonate is computed as 1.2 times the alkalinity expressed in terms of calcium carbonate, as determined by phenolphthalein.

Carbonic acid as carbonate is computed as 0.88 times the same. Bound carbonic acid is computed as 0.44 times the alkalinity expressed in terms of calcium carbonate as determined by methyl red, lacmoid, or erythrosine.

It should be noted that half-bound carbonic acid is equal to one-half the bicarbonate carbonic acid and that the bound is the sum of the carbonic acid as carbonate and one-half that as bicarbonate.

For the determination of alkalinity the reader is referred to the Report of the Committee on Standard Methods of Water Analysis.

**Solubility of Carbonic Acid.**—Carbonic acid will dissolve readily in water. The amount that will remain in solution depends upon the partial pressure of  $\text{CO}_2$  in the atmosphere over the water. In the open air this partial pressure is low, and water exposed to the open air in drops seldom contains more than 1 or 2 parts per million of free  $\text{CO}_2$ . The air in dug wells often contains a good deal of carbonic acid, so that groundwaters often held very large amounts of this gas.

Carbonic acid has a natural affinity for calcium carbonate and in water will combine with it to form the soluble bicarbonate. In fact, waters become hard only as this action takes place, both limestone and the dissolved gas being necessary.

## SOLUBILITY OF CARBONIC ACID IN WATER.

(Compiled from Sutton's Volumetric Analysis and Fox's paper in the Transactions of the Faraday Society, September, 1909.)

Temperature, Centigrade.	CC. per Liter.	Parts per Million for Stated Partial Pressures of CO <sub>2</sub> in the Atmosphere.			
	1 part per 10,000.	1 part per 10,000.	4 parts per 10,000.	6 parts per 10,000.	8 parts per 10,000.
0	.1713	.34	1.4	2.0	2.8
4	.1473	.29	1.2	1.7	2.4
8	.1283	.26	1.0	1.5	2.0
12	.1117	.22	.9	1.3	1.8
16	.0987	.19	.8	1.2	1.6
20	.0877	.17	.7	1.0	2.0
24	.0780	.15	.6	.9	1.8
28	.0780	.15	.6	.9	1.8

**Sources of Oxygen and Carbonic Acid.**—The principal sources of dissolved oxygen in the water of lakes are the atmosphere and the process of photo-synthesis which takes place in green plants. The principal sources of dissolved carbonic acid are decomposition of organic matter and the respiration of animals and plants. Only to a slight extent is carbonic acid absorbed from the atmosphere. Sometimes, however, this is an important item. Ground-water usually contains more carbonic acid than surface-water and when this is discharged into a lake it naturally adds carbonic acid to the water.

Carbonic acid also exists in water in loose combination with the carbonates of calcium and magnesium—forming the so-called bicarbonates. In this form the carbonic acid is said to be half-bound. Certain organisms have the power of taking this half-bound carbonic acid away from the bicarbonates and utilizing it, leaving the water slightly alkaline to phenolphthalein. Such water has the power of taking up carbonic acid from the air more readily than water which is slightly acid to this indicator.

**Absorption and Diffusion of Oxygen and Carbonic Acid.**—The rate of absorption of oxygen, from the air and its diffusion through water is very slow in still water. To a very con-

siderable extent the absorption is dependent upon mechanical mixture by wave action by currents produced by the winds, by vertical convection currents, and by artificial agitation, such as by boats, etc. These factors however are very important.

The greatest interchange of gases between water and air takes place in the processes of aëration when the water is brought in contact with the air as thin films or as drops.

**A Lake as a Closed Community.**—Dr. Birge has well said “The inhabitants of an inland lake form a closed community in a stricter sense, perhaps, than the term can be applied to any other non-parasitic assemblage. The number of species living under these conditions is small and closely similar in different lakes. Only small additions are made to the food supply from without and these come slowly. The lake is dependent on its own stock of green plants for the stock of organic matter available for food of other organisms; and the possible amount of green plants is limited by the raw material supplied for photosynthesis from the lake itself. The critical factor then, in the economy of a lake with small in- and outflow of water, is the provision for the vertical circulation of the water in the lake. But this circulation is very imperfectly effected at best, and is often wholly absent for most of the water.

“All of these factors co-operate to produce an annual cycle in the distribution of the dissolved gases, whose fundamental features are the same, but whose details differ endlessly in different lakes.”

**Seasonal Changes in Dissolved Oxygen.**—It must be remembered in the first place that water at a summer temperature—say 20° C.—holds, when saturated, only five-eighths as much dissolved oxygen as at winter temperature—0° C. So that water saturated at summer temperature actually contains less oxygen than water only 65 per cent saturated in winter.

In lakes and reservoirs used for public water-supply the water above the transition zone is usually saturated with oxygen. This is because of the constant circulation of the water which continually brings it in contact with the air. In the stagnation zone there is usually a depletion of the oxygen,

and if the amount of organic matter at the bottom is large, so that decomposition is active, the oxygen may be nearly or completely exhausted. Usually there is a gradual reduction within and below the transition zone. Sometimes however the change is very sharp. Thus in Irondequoit Bay, near Rochester, N. Y., on Aug. 8, 1912, analyses showed the following percentages of saturation with dissolved oxygen at different depths.

## DISSOLVED OXYGEN IN IRONDEQUOIT BAY

Depth in Feet.	Temperature, Deg. F.	Per cent of Saturation.
0	69.8	100.0
27	63.6	80.0
28	61.5	12.1
29	60.5	2.2
30	59.5	1.5
36	52.0	0.0
75	45.3	0.0

The decay of algæ in a reservoir may reduce the dissolved oxygen even at the surface. Thus during the autumn of 1913 the dissolved oxygen in the water of Fresh Pond, Cambridge, remained below 80 per cent for several weeks.

It sometimes happens that algæ are concentrated at the transition zone and that through photo-synthesis oxygen is produced more rapidly than it can be diffused—hence a condition of super-saturation there may result, the percentage of saturation rising to 200 per cent or even 300 per cent. In this condition the oxygen is probably in or attached to the organisms rather than actually in solution.

In the winter, when the surface is frozen, the oxygen supply from the air is cut off, while the photo-synthetic processes are at a low ebb, partly because of the cold and partly because the amount of sunlight received is less. Yet respiration and decomposition continue, although these processes also are reduced in activity. The result is that beneath the ice the oxygen in the water tends to diminish. It is seldom greatly reduced unless the bottom of the lake is foul and the decomposition excessive.

At the times of the spring and fall overturn the water is usually well aerated from top to bottom.

Again in shallow bodies of water the decay of organisms and organic matter may cause a depletion of oxygen sufficient to kill fish.

**Seasonal Changes in Carbonic Acid.**—In lakes and reservoirs where there are few algæ or aquatic plants, that is where photo-synthesis is not taking place to any extent, the water near the surface contains normally a small amount of carbonic acid—usually less than 2 parts per million. If decomposition is taking place this amount may be somewhat greater. If, however, green plants are present and food building is in process, the amount of carbonic acid may be entirely absent. And, more than that, some of the carbonic acid may be removed from the bicarbonates, leaving normal carbonates of calcium and magnesium, which are not very soluble. If the amounts of bicarbonates were originally large there may be a precipitation of calcium carbonate brought about in this way. When carbonic acid has been thus removed from the bicarbonates the water is alkaline to phenolphthalein, (the indicator used to detect carbonic acid), that is, the carbonic acid result becomes negative.

Just what algæ and water plants are able to take away carbonic acid from the bicarbonates is not known. Possibly all of them do. It is believed that such water weeds as Potamogeton, Carex, and Batrachium, draw heavily on the bicarbonates, and it is also known that blue-green algæ, such as Anabaena and Clathrocystis, and diatoms, such as Asterionella, will do the same.

In general, then, in summer the carbonic acid tends to decrease above the transition zone and to increase below it. This is illustrated by Fig. 49.

In shallow ponds the rise and fall of the carbonic acid indicates the relative importance of the changes of growth and decay.

The most complete study of dissolved carbonic acid in lake waters is that made by Dr. Birge and Dr. Juday. Fig. 50, copied from their valuable monograph, illustrates these changes in a very striking way.

**Relation of Dissolved Gases to Algæ.** The best discussion of this subject is to be found in a paper by Dr. Charles O. Chambers published in the twenty-third annual report of the Missouri Botanical Gardens, issued Dec. 18, 1912. Chambers has not only compiled data from various foreign laboratories but has carried on a series of experiments made in the lagoons of the

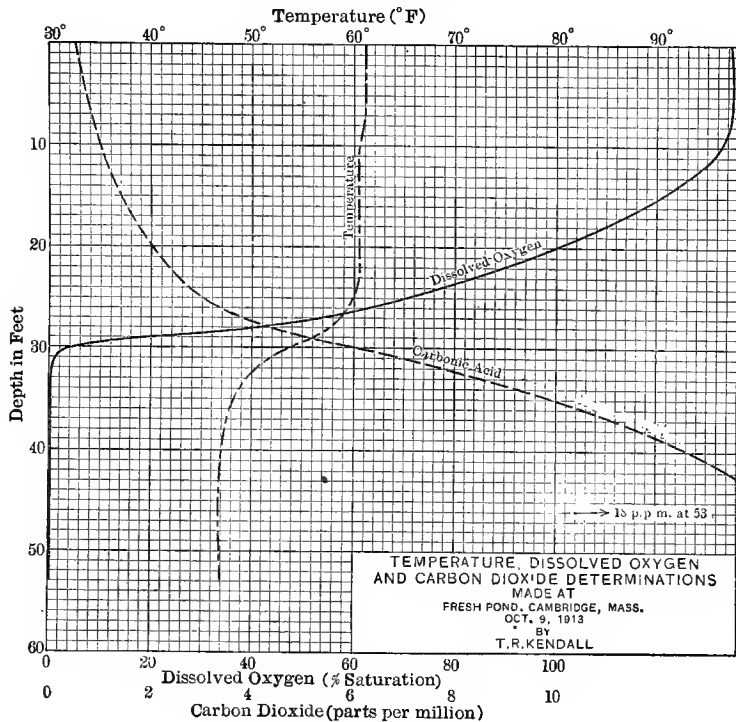

FIG. 49.

botanic gardens at St. Louis, where blue-green algæ were growing. Of especial interest is his observation that on clear, sunny days the water became supersaturated with dissolved oxygen, while on cloudy days the percentage of oxygen fell below saturation, sometimes as low as 40 per cent. In general the carbonic acid increased as the oxygen decreased, but this reciprocal relation did not always hold. This same fluctuation in gaseous

contents also occurs between day and night according to authorities quoted. Another interesting finding is that aëration tends to the formation of individual cells, while in poorly aërated water there is a tendency for organisms to form colonies and filaments.

Chambers has summarized the results of his findings as follows:

1. There is an intimate and mutual relation between the algæ and submerged aquatics in a body of water and the gases dissolved in that water. They fluctuate together.

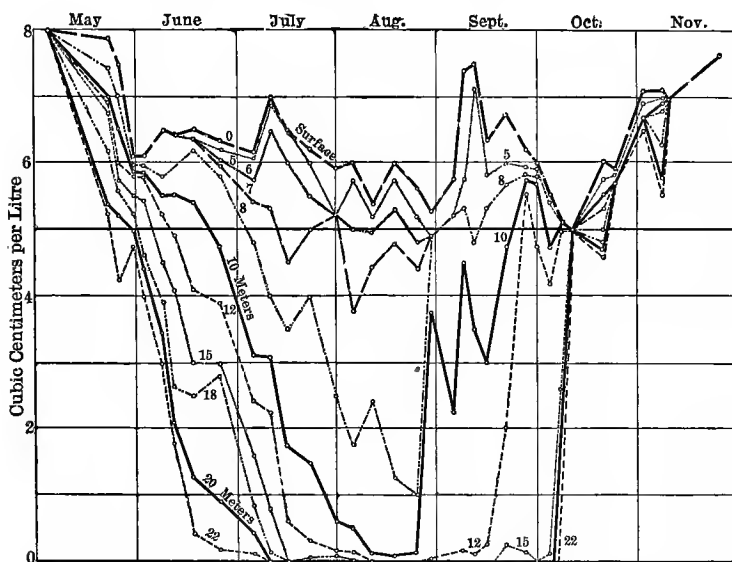

FIG. 50.—Dissolved Oxygen at Different Depths in Lake Mendota.  
After Birge and Juday.

2. Air, or its constituents, oxygen and  $\text{CO}_2$ , are as essential to water plants as water is to land plants, and equally difficult to secure.

3. Warm and stagnant water is poorer in these essentials than colder water gently agitated by wind or currents.

4. Currents are especially beneficial to attached plants by renewing or removing these gases.

5. Some species demand more aëration than others. Some species are more tolerant of stagnant waters than others.

6. Filamentous forms with large cells and thin outer walls are best adapted to stagnant waters. Such forms predominate in warm, tropical fresh waters, which are poorly aërated.

7. The photo-synthesis of rapidly-growing algæ and aquatic plants in a body of water may diminish or deplete the supply of  $\text{CO}_2$  and increase the oxygen content beyond saturation.

8. In the absence of free  $\text{CO}_2$  the plants may utilize the half-bound  $\text{CO}_2$  of the dissolved bicarbonates, chiefly those of calcium and magnesium.

9. The process of photo-synthesis may be so vigorous as to exhaust the half-bound  $\text{CO}_2$  and render the water alkaline. By respiration and absorption of  $\text{CO}_2$  from the air more bicarbonates may be formed. This serves as a mechanism for the conservation of  $\text{CO}_2$ .

10. Waters rich in lime-carbonates are also rich in vegetation. Bog waters, containing humic acids, and; consequently, poor in carbonates of lime, are known to be poor in vegetation.

11. Stagnant water, on account of the large amount of  $\text{CO}_2$  and the small amount of oxygen, favors the formation of colonies and filaments rather than of free individual cells.

12. Colonies and filamentous forms may be produced artificially with some plants, by increasing the amount of  $\text{CO}_2$  or diminishing the amount of oxygen in the culture solutions.

13. Narrow, much-branched filaments are adapted to and produced by poorly aërated waters.

14. Aëration, or abundance of oxygen, apparently favors the formation of chlorophyll; and algæ are brighter green when well aërated.

15. The periodicity of spore formation is not readily influenced by aëration or gas content of the water. It seems to be more a matter of heredity.

**Death of Fish in Weequahic Reservation, Newark, N. J.**—In August, 1906, a large number of fish suddenly died in the lake at the Weequahic Reservation, Newark, N. J. This was investigated by Herbert B. Baldwin and the author, the results

of which may be found in a report made to the Park Commission of Essex County, N. J., for that year.

The lake covered about 80 acres and had an average depth of between 5 and 6 ft., although in a few spots the water was 12 ft. deep. The site of the reservoir was a swamp in which the depth of mud and peaty matter varied from 2 to 10 ft. This mud was not removed when the reservoir was constructed. Aquatic plants, water weeds and filamentous algæ flourished in the lake and at times great masses of peat and stumps have floated to the surface. In the summer heavy growths of blue-green algæ have occurred.

On the night of August 19 twelve two-horse loads of dead fish were picked up on the shore and it was estimated that more than fifteen tons died in two days. The dead fish included bass, roach, sunfish, horn pout, suckers, eels, and a few carp. They varied in size from sunfish 2 inches long to black bass weighing 5 pounds. The investigation showed that the probable cause of the death of the fish was an almost complete exhaustion of oxygen which resulted from the sudden decay of the algæ which had been occurring in the lake. The analyses made by the investigation offered additional testimony to the close relations which exist between carbonic acid, dissolved oxygen, and algæ growths in water.

## CHAPTER IX

### OCCURRENCE OF MICROSCOPIC ORGANISMS IN LAKES AND RESERVOIRS

THE microscopic organisms that are found most commonly in the water-supplies of Massachusetts taken from lakes or storage reservoirs are given in the following table, arranged according to the usual system of classification and divided into groups according to their abundance and frequency of occurrence. The first group includes those genera which, in their season, are often found in large numbers; the second group includes those which are found but occasionally in large numbers; the third, those which often occur in small numbers; the fourth, those which are rarely observed. This division, while not wholly satisfactory, enables one to separate the important from the unimportant forms. As observations multiply, the list may be extended and some genera may be changed from one group to another. The organisms printed in heavy type have given trouble in water-supplies, either by producing odors or by making the water turbid and unsuitable for laundry purposes.

#### DIATOMACEÆ

*Commonly found in large numbers.* **Asterionella**, Cyclo-  
tella, **Melosira**, **Synedra**, **Tabellaria**.

*Occasionally found in large numbers.* Diatoma, Fragilaria,  
Nitzschia, **Stephanodiscus**.

*Commonly found in small numbers.* Epithemia, Gom-  
phonema, Navicula, Stauroneis.

*Occasionally observed.* Achnanthes, Amphiprora, Amphora,  
Bacillaria, Cocconeis, Cocconema, Cymbella, Diademsis, Enco-  
nema, Eunotia, Grammatophora, Himantidium, Isthmia, Mer-

**idion**, *Odontidium*, *Orthosira*, *Pinnularia*, *Pleurosigma*, *Schizone-ma*, *Striatella*, *Surirella*, *Tetracyclus*.

#### CHLOROPHYCEÆ

*Commonly found in large numbers.* *Chlorococcus*, *Protococcus*, **Scenedesmus**.

*Occasionally found in large numbers.* *Cœlastrum*, *Cosmarium*, **Palmella**, **Pandorina**, *Polyedrium*, *Raphidium*, *Staurastrum*, **Volvox**.

*Commonly found in small numbers.* *Closterium*, *Conferva*, *Desmidium*, *Euastrum*, **Eudorina**, *Gonium*, *Micrasterias*, *Ophiocytium*, *Pediastrum*, *Sphærozozma*, *Staurogenia*, *Tetraspora*, *Ulothrix*, *Xanthidium*.

*Occasionally observed.* *Arthrodesmus*, *Bambusina*, *Botryococcus*, *Characium*, *Chætophora*, *Cladophora*, *Dactylococcus*, *Dictyosphærium*, *Dimorphococcus*, *Draparnaldia*, *Glœocystis*, *Hyalotheca*, *Mesocarpus*, *Nephrocytium*, *Penium*, *Selenastrum*, *Sorastrum*, *Spirogyra*, *Stigeoclonium*, *Tetmemorus*, *Zygnema*.

#### CYANOPHYCEÆ

*Commonly found in large numbers.* **Anabæna**, **Clathrocystis**, **Cœlosphærium**, **Microcystis**.

*Occasionally found in large numbers.* **Aphanizomenon**, *Chroococcus* **Oscillaria**.

*Commonly found in small numbers.* *Aphanocapsa*.

*Occasionally observed.* *Glœocapsa*, *Lynngbya*, *Merismopedia*, *Microcoleus*, *Nostoc*, *Rivularia*, *Sirosiphon*, *Tetrapedia*.

#### SCHIZOMYCETES AND FUNGI

*Commonly found in large numbers.* **Crenothrix**.

*Occasionally found in large numbers.* *Cladothrix*, *Chlamydothrix*, *Gallionella*.

*Commonly found in small numbers.* **Beggiatoa**, **Leptothrix**, **Molds**.

*Occasionally observed.* *Achlya*, *Leptomitus*, *Saprolegnia*, *Sarcina*, *Spirillum*.

## PROTOZOA

*Commonly found in large numbers.* **Cryptomonas, Dinobryon, Peridinium, Synura, Uroglena.**

*Occasionally found in large numbers.* Bursaria, Chloromonas, **Glenodinium, Mallomonas, Raphidomonas.**

*Commonly found in small numbers.* Actinophrys, Amoeba, Anthophysa, Ceratium, Cercomonas, Codonella, Epistylis, Monas, Tintinnus, Trachelomonas, Vorticella.

*Occasionally observed.* Acineta, Arcella, Chlamydomonas, Coleps, Colpidium, Cyphodera, Diffugia, Enchelys, Euglena, Euglypha, Euplotes, Glaucoma, Halteria, Heteronema, Nasula, Paramæcium, Phacus, Pleuronema, Raphidodendron, Stentor, Syncrypta, Trichodina, Uvella, Zoothamnium.

## ROTIFERA

*Commonly found in small numbers.* Anuræa, Conochilus, Polyarthra, Rotifera, Synchæta.

*Occasionally observed.* Asplanchna, Colurus, Eosphora, Floscularia, Lacinularia, Mastigocerca, Microcodon, Monocera, Monostyla, Noteus, Sacculus, Triarthra.

## CRUSTACEA

*Commonly found in small numbers.* Bosmina, Cylcops, Daphnia.

*Occasionally observed.* Alona, Cypris, Diaptomus, Sida.

## MISCELLANEOUS

*Occasionally observed.* Acarina, Anguillula, Batrachospermum, Chætonotus, Gordius, Hydra, Macrobiotus, Meyenia, Nais, Spongilla; besides spores, ova, insect scales, pollen grains, vegetable fibers and tissue, yeast-cells, starch-grains, etc.

The above may be summarized numerically as follows:

Classification.	Number of Genera.				Total.
	Commonly found in large numbers.	Occasionally found in large numbers.	Commonly found in small numbers.	Occasionally observed.	
Diatomaceæ.....	5	4	4	22	35
Chlorophyceæ.....	3	8	14	21	46
Cyanophyceæ.....	4	3	1	8	16
Fungi and Schizomycetes..	1	3	3	5	10
Protozoa.....	5	5	11	24	45
Rotifera.....	0	0	5	12	17
Crustacea.....	0	0	3	4	7
Miscellaneous.....	0	0	0	10	10
Total.....	18	23	41	106	188

It will be observed that 188 genera have been recorded, —110 plants and 78 animals. Of these only 18 are commonly found in large numbers—13 plants and 5 animals. 23 more are occasionally found in large numbers—18 plants and 5 animals. 41 genera are frequently seen in small numbers, while 106 genera, or more than one-half of all are seen occasionally, some of them rarely. The most important classes are the Diatomaceæ, Chlorophyceæ, Cyanophyceæ, and Protozoa, as shown by the large number of genera and by their greater abundance. Furthermore, these classes include all the most troublesome genera that have been found in large numbers. There are 10 genera that are particularly troublesome because of their wide distribution, the frequency of their occurrence, and their unpleasant effects. They are *Asterionella*, *Anabæna*, *Clathrocystis*, *Cœlosphærium*, *Aphanizomenon*, *Dinobryon*, *Peridinium*, *Synura*, *Uroglæna*, and *Glenodinium*. This list seems like a short one when one considers the annoyance that the microscopic organisms have caused in various water-supplies.

**Wide Distribution of the Plankton.**—The observations of sanitarians and the planktologists show that the microscopic organisms are very widely distributed in nature. They are found in all parts of the world, and under great varieties of climatic conditions. It is probable that they appeared on the

earth at an early geological age. Some of them are found as fossils—notably the diatoms, which have silicious walls that are almost indestructible.

In spite of the vast amount of study that has been given to the microscopic organisms we are still very far from understanding the laws governing their distribution. Why it is that a certain genus will grow vigorously in one pond and at the same time be absent from a neighboring one where the conditions apparently are as favorable, or why a form may suddenly appear in a pond where it has never before been seen, we are still unable to say with certainty. Solution of such problems involves a far-reaching knowledge of the chemical constituents and the life-history of the organisms, besides the effect of physical conditions, such as temperature, pressure, and light. Mention was made in the last chapter of the probable influence of the dissolved gases, carbonic acid and oxygen. The sciences of bio-chemistry and bio-physics are yet in their infancy. Until these have been further developed many problems connected with the microscopic organisms must remain unsolved.

**Classification of Massachusetts Data made in 1900.**—The following statistics compiled by the author are of some value in connection with this subject, as they show the relative abundance of the different classes of organisms in some of the important surface-water supplies of Massachusetts, together with some of the elements of the sanitary chemical analysis.

For the purpose of this comparison 57 ponds and reservoirs were selected where monthly examinations, both chemical and biological, were carried on for a number of years by the State Board of Health. The results of these examinations were carefully studied, and the lakes, which, for convenience, are made to include lakes, ponds, and storage reservoirs, are divided into groups as shown in the table on pages 138 and 139.

The first two columns in this table give the names of the lakes and the cities which they supply. The third gives the depth, whether shallow or deep. The next four columns show the relative abundance of the four most important classes of organisms; namely, the Diatomaceæ, Chlorophyceæ, Cyano-

CLASSIFICATION OF FIFTY-SEVEN MASSACHUSETTS LAKES AND RESERVOIRS.

(The figures refer to the classes to which the lakes belong.)

City or Town.	Lake or Reservoir.	Depth.	Diatomaceae.	Chloro-phyceae.	Cyano-phyceae.	Protozoa.	Color.	Excess of Chlorine.	Hardness.	Albuminoid Ammonia (in solution).	Free Ammonia.	Nitrates.
Abington.....	Big Sandy Pond.....	○	III	IV	IV	II	I	III	I	II	I	II
Andover.....	Haggett's Pond.....	○	IV	IV	IV	II	I	III	I	III	I	I
Ashburnham.....	Upper Naukeag Pond.....	○	IV	IV	IV	III	I	III	I	II	II	II
Athol.....	Phillipston Reservoir.....	+	III	IV	IV	III	II	III	II	II	II	II
Boston.....	Reservoir No. 6.....	+	III	III	II	IV	IV	III	III	IV	II	II
Boston.....	Reservoir No. 4.....	+	III	III	II	IV	IV	III	III	IV	II	II
Boston.....	Reservoir No. 2.....	+	III	III	II	IV	IV	III	III	IV	II	II
Boston.....	Reservoir No. 3.....	+	III	III	II	IV	IV	III	III	IV	II	II
Boston.....	Lake Cochituate.....	○	I	III	III	III	III	IV	IV	III	IV	III
Boston.....	Frank Pond.....	+	III	III	III	III	I	IV	IV	III	IV	III
Boston.....	Mystic Lake.....	+	I	I	III	I	I	IV	IV	III	IV	III
Boston.....	Jamaica Pond.....	+	I	I	III	III	II	IV	IV	III	IV	III
Brockton.....	Salsbury Brook Reservoir.....	+	I	II	IV	III	II	IV	IV	III	IV	III
Cambridge.....	Fresh Pond.....	○	I	II	IV	III	II	IV	IV	III	IV	III
Cambridge.....	Stony Brook Reservoir.....	○	II	III	IV	III	III	IV	III	III	III	III
Danvers.....	Middletown Pond.....	○	II	III	IV	III	III	IV	III	III	I	III
Fitchburg.....	Scott Reservoir.....	○	I	III	IV	III	I	III	III	II	I	III
Fitchburg.....	Faulnah Reservoir.....	○	I	III	IV	III	I	III	III	II	I	III
Fitchburg.....	Meeting House Pond.....	○	IV	IV	IV	III	I	III	III	II	I	III
Gardner.....	Crystal Lake.....	+	III	IV	IV	III	I	III	III	III	II	III
Gloucester.....	Dikes Brook Reservoir.....	○	II	IV	IV	IV	II	III	II	III	II	II
Gloucester.....	Wallace Pond.....	○	III	IV	IV	III	II	III	II	III	II	II
Gloucester.....	Fernwood Lake.....	○	I	IV	IV	III	IV	III	II	III	II	II
Hingham.....	Accord Pond.....	+	I	IV	IV	III	II	III	II	III	II	II
Hingham.....	Fulling Mill Pond.....	○	I	IV	IV	III	II	III	II	III	II	II
Hinsdale.....	Storage Reservoir.....	○	I	IV	IV	III	II	III	II	III	II	II
Holyoke.....	Whiting Street Reservoir.....	○	II	IV	IV	III	I	III	II	III	I	III
Holyoke.....	Ashley Pond.....	○	I	IV	IV	III	I	III	II	III	I	III

DEPTH.	+	Deep.	Shallow.	EXCESS OF CHLORINE.	FREE AMMONIA.	HARDNESS.	ORGANISMS.	AL+UMINOID AMMONIA.	COLOR.
Hudson.....	+	0	0	I. 0 to 0.10 II. 0.1 to 0.3 III. 0.4 to 2.5 IV. Above 2.5	I. 0 to 0.010 II. 0.010 to 0.030 III. 0.030 to 0.100 IV. Above 0.100	I. 0 to 5 II. 5 to 10 III. 10 to 20 IV. Above 20.	I. Often above 1000 per c.c. II. Occasionally above 1000 per c.c. III. Usually from 100 to 500 per c.c. IV. Below 100 per c.c.	I. 0 to .100 II. .100 to .150 III. .150 to .200 IV. Above .200	I. 0 to 30 II. 30 to 60 III. 60 to 100 IV. above 100.
Gates Pond.....	+	0	0						
Haynes Reservoir.....	+	0	0						
Breed Pond.....	+	0	0						
Birch Pond.....	+	0	0						
Walden Pond.....	+	0	0						
Glenn Lewis Pond.....	+	0	0						
Spot Pond.....	+	0	0						
Lake Williams.....	+	0	0						
Lake Pleasant.....	+	0	0						
Wannacomet Pond.....	+	0	0						
Dug Pond.....	+	0	0						
Lake Quiticus.....	+	0	0						
Doane Pond.....	+	0	0						
Buckmaster Pond.....	+	0	0						
North Pond.....	+	0	0						
Little South Pond.....	+	0	0						
Storage Reservoir.....	+	0	0						
Cape Pond.....	+	0	0						
Wenham Lake.....	+	0	0						
Ludlow Reservoir.....	+	0	0						
Assawamsett Pond.....	+	0	0						
Elders Pond.....	+	0	0						
Upper Sundra Reservoir.....	+	0	0						
North Reservoir.....	+	0	0						
South Reservoir.....	+	0	0						
Middle Reservoir.....	+	0	0						
Horn Pond.....	+	0	0						
Lynde Brook Reservoir.....	+	0	0						
Tatnuck Brook Reservoir.....	+	0	0						

The figures of the chemical analyses are given in parts per million.

phyceæ, and Protozoa. The four groups are characterized as follows: the group to which each pond belongs is indicated by a Roman numeral.

Group I. Number of organisms often as high as 1000 per c.c.

Group II. Number of organisms only occasionally as high as 1000 per c.c.

Group III. Number of organisms ordinarily between 100 and 500 per c.c.

Group IV. Number of organisms never above 100 per c.c.

These figures refer not to the numbers present in the average sample of water, but to the numbers during the season of maximum growth. The boundaries of the groups were not sharply defined, and in a number of cases it was hard to tell whether a lake should be classed in Group II or III. The last five columns show the lakes divided into classes according to some of the elements of the chemical analysis; namely, color, excess of chlorine, hardness, albuminoid ammonia (in solution), free ammonia, and nitrates. In each case four classes are given, division being made according to the schedule given at the bottom of the table.

If we consider the lakes with reference to the growths of organisms, we obtain from the above table the following summary:

Group.	Number per c.c.	Number of Lakes and Reservoirs.			
		Diatomaceæ.	Chlorophyceæ.	Cyanophyceæ.	Protozoa.
I	Often above 1000 per c.c. . . . .	24	5	7	8
II	Occasionally above 1000 per c.c. . . . .	8	11	10	7
III	Usually between 100 and 500 per c.c. . . . .	19	29	18	35
IV	Below 100 per c.c. . . . .	6	12	22	7

From this it appears that the Diatomaceæ were the organisms most commonly found in large numbers. There were 24 ponds (42 per cent of the ponds considered) which often had these organisms as high as 1000 per c.c., while in only 6 (11 per cent) were they always below 100 per c.c. The Chlorophyceæ were not often found in great abundance, though many lakes contained them in moderate numbers. Only 5 lakes

(9 per cent) had growths of 1000 per c.c., while 29 (70 per cent) had growths of from 100 to 500 per c.c. The Cyanophyceæ were not as common as the Chlorophyceæ, but where they did occur their growth was usually greater and they caused more trouble. There were 7 lakes (12 per cent) that commonly had growths above 1000 per c.c., while in 22 (39 per cent) they were never above 100 per c.c. The Protozoa were somewhat more abundant than either the Chlorophyceæ or Cyanophyceæ. Eight lakes (12 per cent) often had growths above 1000 per c.c.; 35 lakes (60 per cent) had growths between 100 and 500 per c.c.

From the table on pages 138 and 139 it also appears that 28 lakes (49 per cent) often had large growths of one or more of these classes of organisms at some time during the year. Such growths, except in the case of certain diatoms, were nearly always noticeable and frequently were very troublesome. In 17 lakes the Diatomaceæ alone reached 1000 per c.c.; in 1 lake the Cyanophyceæ alone; and in 3 lakes the Protozoa alone. One lake had heavy growths of Diatomaceæ, Chlorophyceæ and Protozoa; two, of Diatomaceæ, Chlorophyceæ and Cyanophyceæ; two, of Diatomaceæ, Cyanophyceæ and Protozoa. In two lakes all four classes were found in large numbers. There was but one lake where the organisms never rose above 100 per c.c.; there were 16 where no class of organisms showed numbers greater than 500 per c.c.

**Effect of Depth.**—For the purpose of determining whether the depth of the lake exercised any important influence upon the growth of the organisms the following table was compiled:

Depth.*	Number per c.c.	Number of Lakes.			
		Diatomaceæ.	Chlorophyceæ.	Cyanophyceæ.	Protozoa.
Deep....	Often above 1000 per c.c.....	8	3	2	2
Deep....	Occasionally above 1000 per c.c....	2	2	1	0
Deep....	Usually between 100 and 500 per c.c..	6	8	6	12
Deep....	Always below 100 per c.c.....	0	3	7	2
Shallow..	Often above 1000 per c.c.....	16	2	5	6
Shallow..	Occasionally above 1000 per c.c....	6	9	9	7
Shallow..	Usually between 100 and 500 per c.c..	13	21	12	23
Shallow..	Always below 100 per c.c.....	6	9	15	5

\* Lakes of the Second Order are here called "deep lakes;" lakes of the third order "shallow lakes;" no lakes of the First Order are included. See page 99.

There were 16 deep and 41 shallow lakes. Of the deep lakes 63 per cent at times had growths of the Diatomaceæ above 1000 per c.c., while of the shallow lakes 54 per cent had such growths. There were no deep lakes where the Diatomaceæ were lower than 100 per c.c., while in 15 per cent of the shallow lakes they were lower than that figure. It thus appears that the heavy growths of the Diatomaceæ were somewhat more likely to be found in the deep than in the shallow lakes. The same may be said of the Chlorophyceæ, though the difference was not so marked. 31 per cent of the deep lakes and 27 per cent of the shallow lakes at times had growths as high as 1000 per c.c. The Cyanophyceæ and Protozoa, on the other hand, inclined toward shallower water. In the case of the former, 18 per cent of the deep lakes and 34 per cent of the shallow lakes at times had growths of 1000 per c.c., while in the case of the latter the figures were 12 per cent and 32 per cent respectively.

In this connection it would be of interest to show statistically the relation that undoubtedly exists between the growths of organisms and the character of the material forming the bottoms of the ponds, but unfortunately the necessary data are lacking in too many cases. So far as observations have been made, it appears that muddy bottoms are very largely responsible for excessive growths of microscopic organisms. This topic is mentioned again in Chapter XIII.

**Relation to the Chemical Analysis.**—An important question, and one which is of particular interest to water analysts, is the relation between the growths of organisms and the chemical analysis of the water in which the organisms are found. Unquestionably there must be some relation, but thus far our knowledge of the food requirements of the plankton is not sufficient to enable us to tell what this relation is. Something may be learned, however, by considering the subject statistically.

The tables given on pages 144 and 145 show in a very general way the relation between the organisms in the 57 selected Massachusetts lakes and reservoirs and some of the important elements of the chemical analysis.

These tables reveal several important facts: first, it is seen that the color of the water has an important influence upon the number of organisms that will be found in it. Of the 24 cases where the Diatomaceæ were commonly found higher than 1000 per c.c., 12 (or 50 per cent) occurred in light-colored waters, i.e., water having a color less than 30, and none occurred in water where the average color was above 100. The same fact was noticed in the case of the other organisms, but not as markedly as with the Diatomaceæ. The reason for this may be on account of the difference in specific gravity between the diatoms and the other organisms. The diatoms are heavy by reason of their siliceous cell-walls, but the other organisms are much lighter and it is easier for them to keep near the surface. The depth to which light penetrates in a body of water makes less difference with the growth of the Cyanophyceæ, for example than it does with the diatoms, which constantly tend to sink and which are kept near the surface chiefly by the vertical currents in the water.

**Relation to Excess of Chlorine.**—The “excess of chlorine” means the difference between the amount of chlorine found in a sample of water and that found in the unpolluted water of the same region. To a certain extent it represents the amount of pollution which the water has received. It is important to know whether this element of the analysis bears any relation to the organisms and whether one may rightly infer that a large growth of organisms in a reservoir is any indication of the pollution of a water-supply. A study of the tables shows that only to a small extent did the excess of chlorine accompany the number of organisms observed, though there was a slight tendency for heavy growths of organisms to accompany high excess of chlorine. This fact corresponds with the common observation that vigorous growths of organisms are often observed in ponds or lakes far removed from any possible contamination.

**Relation to Hardness.**—The hardness of a water, i.e., the abundance of carbonates and sulphates of calcium and magnesium, appears to have some influence upon the organisms. This is noticed in all four classes, though it is most marked

## A.

Chemical Analysis. (parts per 1,000,000).		Number of Lakes and Reservoirs in which the Diatomaceæ are.			
		Often above 1000 per c.c.	Occasionally above 1000 per c.c.	Usually be- tween 100 and 500 per c.c.	Below 100 per c.c.
Color	0 to 30	12	4	9	4
	30 to 60	6	2	4	0
	60 to 100	6	1	5	1
	above 100	0	1	1	1
Excess of Chlorine	0	4	2	1	2
	0.1 to 0.3	8	1	8	2
	0.4 to 2.5	8	3	10	2
	above 2.5	4	2	0	0
Hardness	0 to 5	2	1	3	3
	5 to 10	7	4	5	2
	10 to 20	8	0	10	1
	above 20	7	3	1	0
Albuminoid Ammonia (dissolved)	0 to 0.100	2	0	2	1
	0.100 to 0.150	6	1	5	3
	0.150 to 0.200	8	6	7	1
	above 0.200	8	1	5	1
Free Ammonia	0.000 to 0.010	3	2	5	3
	0.010 to 0.030	6	1	10	2
	0.030 to 0.100	8	5	4	1
	above 0.100	7	0	0	0
Nitrates	0 to 0.050	3	3	5	6
	0.050 to 0.100	11	3	13	0
	0.100 to 0.200	6	2	1	0
	above 0.200	4	1	0	0

## B.

Chemical Analysis (parts per 1,000,000).		Number of Lakes and Reservoirs in which the Chlorophyceæ are			
		Often above 1000 per c.c.	Occasionally above 1000 per c.c.	Usually be- tween 100 and 500 per c.c.	Below 100 per c.c.
Color	0 to 30	2	5	14	8
	30 to 60	2	4	5	1
	60 to 100	1	2	8	2
	above 100	0	0	2	1
Excess of Chlorine	0	1	3	4	1
	0.1 to 0.3	1	2	11	5
	0.4 to 2.5	0	4	13	6
	above 2.5	3	2	1	0
Hardness	0 to 5	0	2	3	4
	5 to 10	1	4	8	5
	10 to 20	1	3	13	2
	above 20	3	2	5	1
Albuminoid Ammonia (dissolved)	0 to 0.100	0	0	2	3
	0.100 to 0.150	0	4	7	4
	0.150 to 0.200	2	5	12	3
	above 0.200	3	2	8	2
Free Ammonia	0 to 0.010	0	2	7	4
	0.010 to 0.030	0	1	13	5
	0.030 to 0.010	2	5	8	3
	above 0.100	3	3	1	0
Nitrates	0 to 0.050	0	2	8	6
	0.050 to 0.100	2	6	13	6
	0.100 to 0.200	0	2	7	0
	above 0.200	3	1	1	0

MICROSCOPIC ORGANISMS IN LAKES AND RESERVOIRS 145

Chemical Analysis (parts per 1,000,000).		Number of Lakes and Reservoirs in which the Cyanophyceæ are			
		Often above 1000 per c.c.	Occasionally above 1000 per c.c.	Usually be- tween 100 and 500 per c.c.	Below 100 per c.c.
Color	0 to 30	2	4	12	11
	30 to 60	2	3	4	3
	60 to 100	3	2	1	7
	above 100	0	1	1	1
Excess of Chlorine	0	2	1	3	3
	0.1 to 0.3	1	3	5	10
	0.4 to 2.5	1	5	8	9
	above 2.5	3	1	2	0
Hardness	0 to 5	0	2	1	6
	5 to 10	2	2	4	10
	10 to 20	2	5	7	5
	above 20	3	1	6	1
Albuminoid Ammonia (dissolved)	0 to 0.100	0	0	1	4
	0.100 to 0.150	0	3	6	6
	0.150 to 0.200	2	5	8	7
	above 0.200	5	2	3	5
Free Ammonia	0 to 0.010	0	2	1	10
	0.010 to 0.030	0	2	9	8
	0.030 to 0.100	3	5	6	4
	above 0.100	4	1	2	0
Nitrates	0 to 0.050	1	2	1	12
	0.050 to 0.100	3	4	10	10
	0.100 to 0.200	1	3	5	0
	above 0.200	2	1	2	0

D.

Chemical Analysis (parts per 1,000,000).		Number of Lakes and Reservoirs in which the Protozoa are			
		Often above 1000 per c.c.	Occasionally above 1000 per c.c.	Usually be- tween 100 and 500 per c.c.	Below 100 per c.c.
Color	0 to 30	5	2	20	2
	30 to 60	1	3	6	2
	60 to 100	2	2	8	1
	above 100	0	0	1	2
Excess of Chlorine	0	1	2	5	1
	0.1 to 0.3	1	2	13	3
	0.4 to 2.5	2	3	15	3
	above 2.5	3	0	3	0
Hardness	0 to 5	0	0	7	3
	5 to 10	3	0	12	2
	10 to 20	1	6	10	2
	above 20	4	1	6	0
Albuminoid Ammonia (dissolved)	0 to 0.100	0	0	4	1
	0.100 to 0.150	0	0	13	2
	0.150 to 0.200	5	2	12	3
	above 0.200	3	4	7	1
Free Ammonia	0 to 0.010	1	1	9	2
	0.010 to 0.030	1	1	13	4
	0.030 to 0.100	2	5	10	1
	above 0.100	4	0	3	0
Nitrates	0 to 0.050	0	1	12	3
	0.050 to 0.100	3	4	17	3
	0.100 to 0.200	3	2	3	1
	above 0.200	2	0	3	0

in the case of the Diatomaceæ and Protozoa. For example, of the 10 lakes low in hardness not one had the Protozoa as high as 1000 per c.c., while of the 11 lakes high in hardness every one had Protozoa above 100 per c.c., and 4 commonly had them above 1000 per c.c. It is probable that it is the greater amount of free carbonic acid accompanying the waters of high hardness which stimulates the growth of the organisms, rather than the salts of calcium and magnesium.

**Relation to Nitrates.**—The sanitary chemical analysis ordinarily states the amount of nitrogen present in four different forms, namely, albuminoid ammonia (dissolved and suspended), free ammonia, nitrites and nitrates, which represent four stages in the change of organic to inorganic matter. Since nitrogen is essential to all living matter we naturally expect that organisms will thrive best in waters rich in that element. The above statistics show that this is the case, and that it is true for each class of organisms and for the different conditions of nitrogen tabulated. The free ammonia and nitrates appear to be particularly influential in determining the amount of life present. For example, 10 of the 13 lakes low in free ammonia never show maximum growths of the Cyanophyceæ above 100 per c.c., while 4 of the 7 lakes high in free ammonia commonly have growths above 1000 per c.c.

One must be careful in these matters, however, not to mistake cause for effect. Free ammonia, for example, indicates organic matter in a state of decay, and instead of representing the food of the organisms in question it may represent their decomposition. The interaction of the various organisms is a very complicated question, and the extent to which one organism lives upon the products of decay of another is not well known.

**Studies of Stearns and Drown.**—In 1900, Mr. F. P. Stearns, Chief Engineer, and the late Dr. T. M. Drown, Chief Chemist, of the Massachusetts State Board of Health made a statistical study of Massachusetts Ponds and Reservoirs to ascertain the relation between pollution and the occurrence of bad tastes and odors caused by organisms. Their results, which included

data for 70 ponds and reservoirs for a period of two years were summarized as follows:

CLASSIFICATION OF PONDS AND RESERVOIRS WITH REFERENCE TO TROUBLES FROM BAD TASTES AND ODORS.

Conditions.	Ponds.			Reservoirs.		
	Trouble.			Trouble.		
	Much.	Little.	None.	Much.	Little.	None.
<b>Polluted</b>						
Shallow and high color.....	.....	.....	.....	1	.....	.....
Shallow and low color.....	.....	.....	.....	.....	.....	.....
Deep and high color.....	1	.....	.....	.....	1	.....
Deep and low color.....	3	4	.....	.....	.....	.....
	—	—	—	—	—	—
Total Polluted.....	4	4	.....	1	1	.....
<b>Unpolluted</b>						
Shallow and high color.....	.....	.....	1	10	.....	.....
Shallow and low color.....	3	1	.....	1	.....	2
Deep and high color.....	.....	2	2	1	2	4
Deep and low color.....	1	4	16	3	2	1
	—	—	—	—	—	—
Total unpolluted.....	4	7	19	15	4	7
Total polluted and unpolluted.	8	11	19	16	5	7

“ The above table shows that, out of a total of 38 ponds, 8, or 21 per cent, have given much trouble from bad tastes and odors; while, of the 28 reservoirs, 16, or 57 per cent are similarly affected.

“ In comparing the polluted and unpolluted ponds, the effect of pollution is very obvious. All of the polluted ponds are deep; but, notwithstanding this advantage, all are affected to some extent, and half of them give much trouble. Of the 25 deep, unpolluted ponds, only one has given much trouble, 6 have given a little trouble, and 18 no trouble whatever. This indicates that there is little danger of having serious trouble from bad tastes and odors, if a water supply can be taken from a deep pond which is unpolluted. The shallow, unpolluted

ponds appear to be subject to bad tastes and odors, as 3 out of a total of 5 give much trouble, and 1 a little trouble.

“Only 2 of the reservoirs are polluted, but these give the same indications as the 8 polluted ponds, 1 giving much trouble and the other a little. Of the 26 unpolluted reservoirs, one-half are shallow. Of these 11 give much trouble and 2 give none. In nearly all of these cases in which trouble has occurred, the reservoirs have been constructed on new sites, and the soil and vegetable matter have not been removed from their bottoms and sides. In one of the cases where there is no trouble the reservoir was used to furnish power for a mill before being used as a source of domestic water-supply. The conclusion to be drawn from this comparison is, that a shallow reservoir large enough to hold a supply for a month or more is quite sure to give trouble if the soil and vegetable matter are not removed from it before filling. The experience at the present time is too limited to enable us to predict what proportion of cleaned or old shallow reservoirs are likely to give trouble.

“Of the 13 deep, unpolluted reservoirs, 4 give much trouble, 4 a little and 5 none. It is noticeable that, of the 5 which give no trouble, 4 have had the soil and vegetable matter removed from them, and 1 was previously a storage reservoir for mill purposes; while, of the 8 which have given more or less trouble, none have been thoroughly cleaned, and only one was previously used for mill purposes, and even this has since been raised. Two of the older reservoirs, which are classed as giving little trouble, have not given any trouble in recent years.

“Among the 4 deep reservoirs classed as giving much trouble, is the Ludlow reservoir, at Springfield, which has furnished bad water in summer for 16 years. The other 3 reservoirs of this class have not given nearly as much trouble.

“In several other instances the reservoirs which have given trouble are flowed over swamps and meadows.”

**Classification of New England Data made in 1906.**—In 1906 in connection with a report made by Messrs. Allen Hazen and George W. Fuller, to the Board of Water Supply of the City of New York, on the advisability of removing the soil from the

Ashokan and Kensico reservoirs, the author made a statistical study of the available data relating to the occurrence of microscopic organisms in stored waters. Data were collected for 66 lakes and reservoirs in New England.

In making this comparison the reservoirs were separated into groups according to the frequency of the occurrence of microscopic organisms and into classes according to the odors attributed to the waters.

**Index of Frequency.**—For purposes of comparison the frequency of the occurrence of microscopic organisms and the intensity of their growth were used to obtain a single figure for each reservoir, which was intended to represent relatively the trouble caused by organisms in each reservoir as compared with similar figures for other reservoirs. This figure, which came to be known as the index of frequency was calculated as follows.

It was assumed that when the organisms were less than 500 per c.c. they would cause no trouble; between 500 and 1000 per c.c., little trouble; between 1000 and 2000 noticeable trouble; between 2000 and 3000, decided trouble, and that above 3000 the trouble would be serious. From the analyses the per cents of the time when the organisms were present within these limits were ascertained. These were then weighted as follows and added together: For numbers between 500 and 1000, one-half the per cent; for numbers between 1000 and 2000, the per cent as computed; for numbers between 2000 and 3000, twice the per cent; and for numbers above 3000, three times the per cent. The above was based on organisms of all kinds disregarding genera.

Let us suppose that weekly microscopical analyses gave the results shown in the first two columns of the table on p. 150. The method of computing the index of frequency is indicated by the later columns.

An index of 50 would mean that the growth of organisms were noticeable half of the time, or that if they were present for less than half the time they were more troublesome during the time when they were present.

Number of Organisms per c.c.	Number of Days when Organisms were Found between the Given Limits.	Per Cent of Time	Per Cent Weighted.
0-500	20	38	0
500-1000	15	29	14.5
1000-2000	10	19	19
2000-3000	4	8	16
3000-	3	6	18
	52	100	67.5
			Index of Frequency

The maximum figure for the index of frequency possible by this method of computation would be 300, but it is rare indeed that any natural water gives an index of more than 100, and in the best stored waters the index is generally less than 10. The minimum of course is 0.

The following figures show the numbers of organisms found in three groups of lakes classified according to the index of the frequency as computed in the manner described:

#### LAKES CLASSIFIED ACCORDING TO THE INDEX OF FREQUENCY.

	Group I.	Group II.	Group III.
Number of Lakes and Reservoirs in the group	28	18	20
Limits of Frequency Index . . . . .	0-25	25-50	50-100
Average index of frequency . . . . .	12	39	78
Organisms per c.c. mean yearly average . . . . .	362	776	1410
Organisms per c.c., minimum yearly average . . . . .	54	441	984
Organisms per c.c., maximum yearly average . . . . .	1413	2800	3090
Organisms per c.c., mean average for 4 summer months . . . . .	414	1023	1965
Organisms per c.c., minimum average for 4 summer months . . . . .	66	227	985
Organisms per c.c., maximum average for 4 summer months . . . . .	1058	4588	7659

**Relation of Odor to Index of Frequency.**—Forty-five lakes and reservoirs classified according to odor, and to the index of frequency fell into the following groups:

Group.	Number of Lakes.		
	Group I. 0-25	Group II. 25-50	Group III. 50-100
Frequency Index .....			
<b>ODOR.</b>			
Practically none .....	2	3	0
Faint .....	8	3	0
Distinct .....	5	4	2
Decided .....	1	4	6
Strong .....	1	0	6
	17	14	14

The relation between the frequency of occurrence of microscopic organisms and the odor of the water is thus seen to be very marked.

**Relation to Area of the Lake.**—The following figures show that the relation between the size of the lake and the frequency of occurrence of the organisms was not marked:

Group.	Number of Lakes.		
	I 0-25	II 25-50	III 50-100
Frequency Index .....			
Area in square miles:			
0.00-0.10	7	3	8
0.10-0.25	9	7	4
0.25-0.50	6	3	3
0.50-1.00	2	3	2
1.00 and over	3	1	4
	27	17	21

**Relation to Depth.**—The relation between depth and frequency of occurrence of the microscopic organisms is shown as follows:

Group. Index of Frequency . . . . .	Number of Lakes.		
	I 0-25	II 25-50	III 50-100
Average depth in feet:			
0-10	6	2	2
10-20	12	8	10
20-30	3	1	4
30-40	0	1	0
40 and over	1	0	0
	22	12	16

**Relation to Period of Storage.**—The following figures show the relation between the nominal period of storage of water in a reservoir and the frequency of the occurrence of microscopic organisms:

Group. Index of Frequency . . . . .	Number of Lakes.		
	I 0-25	II 25-50	III 50-100
Period of storage, days:			
0-50	1	1	1
50-100	2	1	1
100-200	7	2	3
200-500	8	4	7
500 and over	2	5	2
	20	13	14

**Relation to Color of the Water.**—There seems to be a slight tendency for the larger growths of organisms to occur in the lighter colored waters:

Group. Index of Frequency . . . . .	Number of Lakes.		
	I 0-25	II 25-50	III 50-100
Color of water:			
0-20	7	4	3
20-40	12	9	13
40-60	5	4	5
60-80	2	0	0
80-100	1	0	0
	27	17	21

**Relation to Population on Watershed.**—The following figures do not show any marked tendency for the organisms to increase as the population on the watershed increases, that is to say the element of pollution is not a controlling one. Yet we know that when the population per square mile is greater than any given in the table this may be a matter of importance.

Group. Index of Frequency . . . . .	Number of Lakes.		
	I 0-25	II 25-50	III 50-100
Population per Sq. Mile:			
0-10	4	5	4
10-50	6	3	6
50-100	3	3	2
100-200	4	1	1
200 and over	3	3	2
	20	15	15

**Occurrence of Anabæna.**—The following statistics show the relation between the occurrence of a typical blue-green algæ and some of the various factors previously mentioned.

Group.	Number of Lakes and Reservoirs.		
	A None.	B Slight.	C Much.
Trouble from Anabæna.			
Area of Lake, miles:			
0-.1	24	14	10
.1-.25	9	6	14
.25-.50	3	6	7
.50-1.00	2	0	1
1.00 and over	1	2	2
Average depth, feet:			
0-10	17	6	1
10-20	10	7	17
20-30	1	0	3
30-40	0	0	0
40-	0	0	0
Length of storage, days:			
0-50	5	1	1
50-100	1	0	2
100-200	2	4	1
200-500	6	4	11
500-	2	1	4
Color of water:			
0-20	20	16	16
20-40	9	5	13
40-60	0	6	2
60-80	2	1	2
80-100	1	0	0
Population per sq. mile:			
0-10	15	5	9
10-50	15	8	8
50-100	7	8	5
100-200	4	3	4
200-	4	3	7

**Algæ in the Croton Water-supply of New York City.**—The present water-supply of New York City is taken from artificial reservoirs and natural lakes on the Croton River catchment area. In no case was the soil removed from the sites before the

reservoirs were filled. Very heavy growths have accordingly occurred in all of the reservoirs and this is also true of the distribution reservoirs in Central Park. The water as delivered in the city usually has a taste and odor caused by these growths. At times it is very noticeable and most unpleasant. It is largely for this reason that filtration of the water has been repeatedly urged in recent years.

The table on page 156 shows the index of frequency of the occurrence of growths of organisms in a number of the Croton reservoirs, together with various data that bear upon the problem.

**Algæ in the Metropolitan Water-supply of Boston.**—Most of the reservoirs of the Metropolitan Water-supply of Boston are less troubled with algæ than the reservoirs of the Croton supply. This may be seen by comparing the table on page 157 with the preceding.

**Algæ in Massachusetts Water-supplies.**—The relative occurrences of algæ in other reservoirs in Massachusetts are shown by the following indices of frequency:

City.	Lake or Reservoir.	Index of Frequency.
Woburn.....	Horn Pond.....	110
Winchester.....	Middle Reservoir.....	97
Springfield.....	Ludlow Reservoir.....	92
Leominster.....	Haynes Reservoir.....	81
Cambridge.....	Fresh Pond.....	73
Cambridge.....	Hobb's Brook.....	71
Lynn.....	Glen Lewis Reservoir.....	65
Salem.....	Wenham Lake.....	56
Holyoke.....	Whiting St. Reservoir.....	55
Lynn.....	Walden Pond.....	45
Cambridge.....	Stony Brook Reservoir.....	41
Leominster.....	Morse Reservoir.....	39
Winchester.....	North Reservoir.....	37
Winchester.....	South Reservoir.....	33
Worcester.....	Tatnuck Brook Storage.....	33
Norwood.....	Buckmaster.....	21
Lynn.....	Breeds Pond.....	17
Hudson.....	Gate Pond.....	16
Lynn.....	Hawkes Pond.....	15
Worcester.....	Leicester supply.....	9
Salem.....	Langham Reservoir.....	5
Taunton.....	Elders Pond.....	4

TABLE SHOWING VARIOUS DATA RELATING TO THE OCCURRENCE OF MICROSCOPIC ORGANISMS IN THE RESERVOIRS OF THE CROTON WATER-SUPPLY OF NEW YORK CITY.

Compiled in 1907.

Lake or Reservoir.	Microscopic Organisms.			Drainage Area, Square Miles.	Area of Water Surface, Square Miles.	Average Depth, Feet.	Maximum Depth, Feet.	Storage Capacity, Days' Flow.	Swamp Area on Watershed, Square Miles.	Swamp Area, Per Cent of Watershed.	Ratio of Swamp Area to Water Surface.	Average Color of Water.	Population per Square Mile on Watershed.	Storage Capacity in Million Gallons.	Date when Reservoir was Put in Use.
	Frequency Rating.		Average Number per c.c.												
	Entire Year.	Entire Year.	Summer Months.												
Middle Branch Res.	83	1732	2048	20.51	0.77	25	50	195	1.17	6.0	1.5	22	31	4005.0	1870
Kirk Lake.	81	1230	1132	2.84	0.16	17	65	198	.88	.00	.8	41	65	505.0	1870
Muscot Res.	72	1069	1239	18.45	1.10	29	64	400	0.88	.00	0.8	22	50	6692.0	1897
West Branch Res.	70	1084	1210	18.43	2.02	23.8	40	535	0.48	2.0	2.0	27	24	10070.0	1895
Titus Res.	59	1698	1271	22.80	1.30	26.4	75	315	1.00	4.0	0.77	26	47	7107.0	1893
Sodom Res.	46	807	699	73.23	0.89	26	88	67	5.38	7.0	0.0	30	38	4900.0	1891
Croton Lake, Old.	46	763	890	158.7	1.75	...	90	...	4.70	3.0	2.7	33	74	...	1842
Bog Brook Res.	43	778	771	3.67	0.64	31	50	1130	0.18	5.0	0.28	25	56	4145.0	1891
Lake Mahopac.	36	447	227	1.03	0.88	...	85	560	...	...	...	15	126	575.0	1870
Boyd's Corner Res.	10	264	444	21.43	.44	29.8	50	127	0.45	0.2	1.0	30	27	2720.0	1873
Lake Glenelg.	3	219	348	0.58	.28	2.8	100	243	...	...	...	11	390	165.0	1870
Lake Glend.	0	50	94	0.65	.19	9.6	100	585	...	...	...	11	61	380.0	1870

TABLE SHOWING VARIOUS DATA RELATING TO THE OCCURRENCE OF MICROSCOPIC ORGANISMS IN THE  
 RESERVOIR OF THE METROPOLITAN WATER-SUPPLY, OF BOSTON, MASSACHUSETTS.

Reservoir.	Microscopic Organisms.			Year when Built or Put in Use.	Drainage Area in Sq. Miles.	Area of Water Surface in Square Miles.	Maximum Depth in Feet.	Average Depth in Feet.	Storage Capacity in Days.	Area of Swamp Land in Square Miles.	Swamp Area Per Cent of Water Surface.	Ratio of Swamp Area to Area of Reservoir.	Per Cent of Water Surface.	Color of Influent.
	Frequency Rating Entire Year.	Ave. No. of Organisms per c.c. Entire Year.	Ave. No. of Organisms per c.c. Summer Months.											
Lake Cochituate. . . . .	50	783	663	1848	18.87	1.23	72	.....	.....	4.35	23.1	3.56	6	60
Framingham No. 3. . . . .	26	475	689	1878	5.40	.396	25	.15	220	.15	7.0	.38	7	40
Hopkinton. . . . .	25	453	682	1894	5.86	.29	55	.....	.....	.85	14.	2.93	5	150
Sandbury. . . . .	24	461	649	1897	22.28	2.02	67	.....	.....	1.85	8.	0.92	0	50
Whitchall. . . . .	21	406	412	.....	4.35	.94	18	.....	.....	.13	3.0	0.14	22	60
Wachusett. . . . .	20	541	386	1905	118.23	6.56	129	46.2	534	3.55	3.0	0.96	6	50
Ashland. . . . .	7	214	321	1885	6.43	.26	49	.....	.....	.52	8.1	2.18	4	140
Framingham No. 2. . . . .	5	190	429	1878	28.50	.21	18	.....	.....	2.17	8	10.3	1	95

**Algæ in Connecticut Water-supplies.**—The following figures show the relative occurrences of algæ in certain water-supplies of Connecticut.

City.	Lake or Reservoir.	Index of Frequency.
Bridgeport.....	Island Brook Supply.....	83
New Haven.....	Dawson Lake.....	79
Meriden.....	Merimere Lake.....	74
New Britain.....	Shuttle Meadow Lake.....	55
Middletown.....	Laurel Brook Reservoir.....	45
Bridgeport.....	Poquonnock River Supply.....	40
Hartford.....	Reservoir No. 6.....	29
Norwich.....	Fairview Reservoir.....	22
New Haven.....	Whitney Lake.....	21
Hartford.....	Reservoir No. 1.....	18
Bridgeport.....	Mill River Supply.....	18
Hartford.....	Reservoir No. 3.....	12
New Haven.....	Wintergreen Lake.....	12
New Haven.....	Saltondell Lake.....	0
Hartford.....	Reservoir No. 2.....	0
Hartford.....	Reservoir No. 5.....	0
New London.....	Lake Konomoc.....	0

**Algæ in Lake Ontario.**—In August, 1912, studies of the plankton were made by the author in Lake Ontario and the Genesee River, assisted by Mr. Melville C. Whipple and Dr. J. W. M. Bunker, instructors in the Harvard School of Engineering. These studies illustrated the effect of horizontal currents on the distribution of the organisms near the shore, and also the relations between different classes of organisms. Speaking of the lake studies the report states:

“Determinations of the microscopic organisms in the lake water were made on July 27th, August 2d and August 5th. In all of these samples diatoms and algæ were present in considerable variety. Generally speaking, these were more numerous at the surface than at the bottom, although certain species were occasionally found in greatest abundance at some intermediate point. In the samples collected near the shore, the number of microscopic organisms in the bottom samples varied according to the direction of the wind. When the wind caused the surface-water to flow out at the bottom, the microscopic organisms were abundant

in the bottom samples, but when the wind was off shore and cold, deep water being brought in at the bottom, the numbers of microscopic organisms in the bottom samples were lower. The microscopical examination of the surface-water along the beaches corroborated the temperature findings in indicating that with an off-shore wind the water at the shore line came from the bottom of the lake."

The protozoa that live upon bacteria and other microscopic organisms were most abundant in the immediate vicinity of the river mouth, and this was even true of the crustacea and rotifera. On August 15th a special study was made of the distribution of these larger organisms constituting the plankton, by the use of a plankton net. This net, kindly furnished by Prof. Charles Wright Dodge, was lowered to a depth of about 20 ft. and drawn to the surface at the rate of 1 ft. per second, in such a way as to collect the organisms present in about 100 gallons of water. The numbers of organisms found in the collected material were counted with the following approximate results:

## PLANKTON IN LAKE ONTARIO

Samples from	Approximate Number of Organisms per Liter.	
	Rotifera.	Crustacea.
Genesee River, opposite Naval Reserve Station. . . . .	12	20
Genesee River, at mouth. . . . .	285	23
Lake Ontario, $\frac{1}{4}$ mile from mouth of river. . . . .	200	968
Lake Ontario $\frac{1}{2}$ mile from mouth of river. . . . .	140	1035
Lake Ontario 1 mile from mouth of river. . . . .	25	30

**Self Purification in the Genesee River.**—At the present time all of the sewage of Rochester is discharged into the Genesee River. The self-purification that takes place in the river in the six-mile reach between the main sewer outfall and the lake is due to a considerable extent to the microscopic organisms. The report says:

“ For convenience the results of the microscopical examinations of the river water have been summarized according to their natural classification, namely, (1) Bacteria, (2) Algæ, (3) Protozoa, (4) Rotifera, and (4) Crustacea.

“ Sedimentation is only one method by which the bacteria in the river are removed from the water. Another important factor is their destruction by larger microscopic organisms. These microscopic organisms, algæ, protozoa, rotifera, crustacea, etc., play an important part in the self-purification of the Genesee River during warm weather. A somewhat extended study of these organisms was made. Samples for microscopical examination were collected on different days at various points between the East Side Trunk Sewer and the lake at the surface, mid-depth and bottom. The variations in the relative numbers of the organisms of these different groups at various places in the river below the East Side Trunk Sewer illustrate in a typical way the biological action involved in the self-purification of a stream.

Immediately below the outlet of the trunk sewer there was a zone of heavy pollution within which the numbers of bacteria were very high, but the crustacea relatively low. Below this point of maximum bacterial life, the numbers of bacteria decreased to the lake. In the vicinity of the intense bacterial pollution and for a short distance below it, the numbers of protozoa were high, as might be expected from the fact that these organisms consume bacteria as food. At the same time there was a slight increase in the algæ, and their numbers were well maintained down-stream to the river mouth. These vegetable cells utilize as food the oxidized products of the organic matter from the sewage. In the lower course of the river, for two or three miles back from the lake, the rotifera and crustacea made their appearance. They live upon the algæ and bacteria and especially upon the protozoa. Large numbers of crustacea were found in the lake hovering around the mouth of the river, waiting for the food that was being carried to them. Studies of these so-called plankton forms were made in the lake by the use of the plankton net, the results of which are

given above. These crustacea serve as food for fish and that is why fish are attracted to the mouth of the river and why fishermen congregate along the breakwaters at the river mouth that extend about a third of a mile into the lake. These

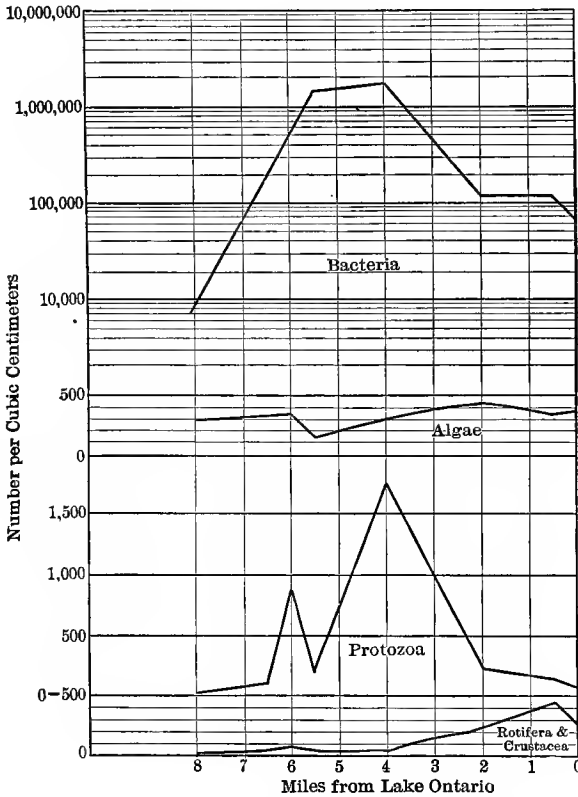

FIG. 51.—Changes in Microscopic Organisms in the Genesee River between the Rochester Sewer Outlet and Lake Ontario. August, 1912.

changing biological conditions are illustrated by diagram in Fig. 51.

**Forbes' Investigations of the Illinois River.**—A very important investigation of the plankton in the water in the Illinois River before and after the opening of the Chicago Drainage Canal was

made by Forbes and Richardson of the University of Illinois. They found that there has been a threefold increase in the spring plankton since the canal was opened and the food-supply of the organisms increased by the turning of the sewage of Chicago into the river. In their very interesting paper published in 1913, they state:

“No change has recently occurred in the Illinois River system, or in the basin of the Illinois, to account for the increased productivity of its water except the opening of the sanitary canal connecting the Illinois and the Chicago rivers at the beginning of 1900. The effects of this occurrence on the plant and animal products of the stream may conceivably have been produced in one or more of these three principal methods: (*a*) by a mere increase of the waters themselves, which, in so sluggish a stream as the Illinois, with bottom-lands so extensive and so widely overflowed by so small a rise of the river levels, will take effect mainly in great expansions of shallow water, long continued or permanently maintained, with muddy bottoms and more or less weedy shores—situations quite capable of producing a relatively enormous plankton as well as an abundant supply of shore and bottom animals and plants; (*b*) by the addition of increased quantities of organic matter to the contents of the stream in the form of a larger inflow of sewage from Chicago and its suburbs, in condition to increase the plankton by increasing the supply of food available to the minute organisms which compose it; and (*c*) by the addition to the plankton of the river, of that of Lake Michigan brought down in the waters of the canal.”

“The efficacy of the first of these conditions is undoubted and that of the second is, generally speaking, quite possible. The importance of an abundance of organic matter in the water as a means of producing a rich plankton is, in fact, so well known that growers of pond fishes in Europe deliberately manure their ponds to increase the supply of food for their fish; and there is considerable evidence, also, that the plankton of the Elbe is largely increased by the sewage of Hamburg and Altona poured directly into that stream.”

In order to show the variations in the quantity of plankton in the river through the course of a year, the following figures are also quoted from their report.

QUANTITY OF PLANKTON IN THE WATER OF THE ILLINOIS RIVER AT HAVANA, ILL. BEFORE AND AFTER THE OPENING OF THE CHICAGO DRAINAGE CANAL.

Month.	Cubic Centimeters of Plankton per Cubic Meter of Water.	
	1896.	1909-10.
Jan.	.01	.01
Feb.	.01	.21
Mar.	.07	2.18
Apr.	5.69	29.60
May	1.30	12.27
June	.71	11.89
July	1.44	.23
Aug.	1.17	.06
Sept.	.38	.10
Oct.	1.10	2.58
Nov.	.02	1.38
Dec.	.76	.38

**Algæ in Ice.**—Algæ sometimes become frozen in the ice of ponds. They give the ice a dirty appearance and on decay may cause foul odors months after the ice is harvested. In artificial ice algæ may be concentrated in the "core," so as to produce a noticeable discoloration and taste.

## CHAPTER X

### SEASONAL DISTRIBUTION OF MICROSCOPIC ORGANISMS

THE microscopic organisms found in water show variations in their seasonal occurrence as great and almost as characteristic as those of land plants. The succession of dandelions, buttercups, and goldenrod in our fields finds its counterpart in the succession of diatoms, green algæ, and blue-green algæ in our lakes and ponds. If one examines the water of a lake

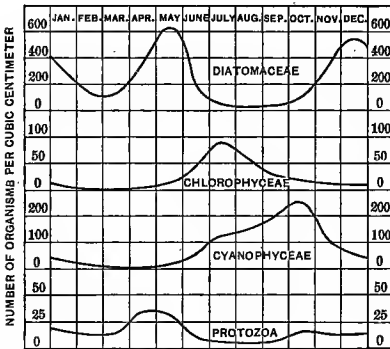

FIG. 52.—Seasonal Distribution of Microscopic Organisms in Lake Cochituate.

continuously for a year some interesting changes in its flora and fauna may be observed. If the lake is a typical one the water during the winter will contain comparatively few organisms; in the spring various diatoms will appear; these will disappear in a few weeks and in their place will come the green algæ; at the same time, or a little later, the blue-green algæ may be found; in the fall both of these will vanish and the diatoms will appear again; as the lake freezes these in turn will disappear. Similar but less characteristic fluctuations take place among the animal forms. These facts are shown graphically in Fig. 52, which represents the seasonal changes that occur among the more important organisms in Lake Cochituate. The diagram is based on weekly observations

extending over a number of years. The seasonal distributions of the diatoms, algæ, and protozoa, are so different that it is best to consider each class by itself.

**Seasonal Distribution of Diatomaceæ.**—In most natural ponds and storage reservoirs diatoms are far more abundant in the spring and fall than at other seasons. New growths seldom begin in the summer or winter, but the spring and fall growths sometimes linger into the summer and winter for a number of weeks.

The occurrence of diatoms in ponds is greatly influenced by the vertical circulation of the water. They generally appear after the periods of stagnation and during the periods of complete vertical circulation. It has been found that in temperate lakes of the second order, which have well-marked periods of stagnation in summer and in winter, the spring and fall growths of *Asterionella* occur with great regularity and with about equal intensity, while in temperate lakes of the third order, which are stagnant only during the winter, the *Asterionella* growths in the autumn are either small compared with the spring growths or are lacking altogether. In deep ponds the spring growths occur earlier and the fall growths considerably later than in shallow ponds, thus again corresponding to the periods of circulation. In lakes of the third order diatoms are sometimes found during the summer after periods of partial stagnation.

Of the many genera of diatomaceæ that are observed in water only those that are true plankton forms exhibit the spring and fall maxima. The most important of these are *Asterionella*, *Tabellaria*, *Melosira*, *Synedra*, *Stephanodiscus*, *Cyclotella*, and *Diatoma*. Other genera are more uniformly distributed through the year. All of these seven genera are sometimes, but not often, observed during the same season in the same body of water. As a rule certain ponds have certain diatoms peculiar to them. For example, Lake Cochituate often contains large growths of *Asterionella*, *Tabellaria*, and *Melosira*: other diatoms are to be found, but they are seldom very numerous. Sudbury Reservoir, No. 3 of the Boston Water

Works contains *Asterionella*, *Tabellaria*, and *Synedra*, but few *Stephanodiscus* or *Melosira*. In Sudbury Reservoir No. 2 only *Synedra* and *Cyclotella* are found. In the Ashland Reservoir *Cyclotella* usually predominates. Fresh Pond, Cambridge, Mass., is famous for its *Stephanodiscus*, and *Diatoma* is common in the water-supply of Lynn, Mass.

The genera that appear in any pond are not the same every year. In Lake Cochituate the spring growth in 1890 consisted of *Asterionella* and *Tabellaria*; in 1891 of *Asterionella* with a

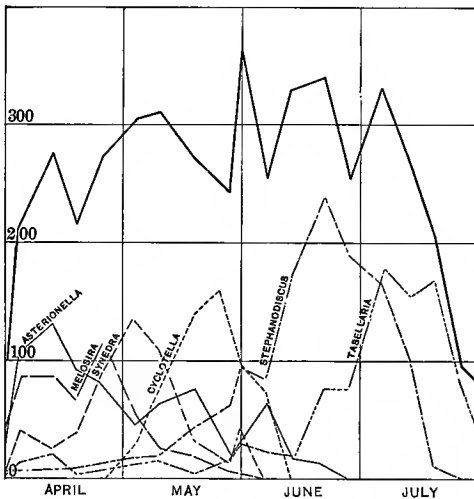

FIG. 53.—Succession of Diatoms in Chestnut Hill Reservoir, 1892.

few *Melosira*; in 1892 of *Melosira* chiefly; in 1893 of *Melosira* and *Asterionella*; and in 1894 of *Tabellaria*, *Asterionella*, and *Melosira*. Furthermore, in any season it is seldom that two genera attain their maximum development at the same time—sometimes one appears first and sometimes another. The most interesting succession of genera that the author has observed occurred in 1892 in Chestnut Hill Reservoir of the Boston Water Works. The spring growth began in April and continued through July. For three months the total number of diatoms present did not materially change, but

during this time six different genera appeared on the scene, culminated one after another, and disappeared. This is shown in Fig. 53.

The explanation of the peculiar seasonal distribution of diatoms involves the answers to many questions. To what extent are diatoms influenced by light, by temperature, by mechanical agitation? To what extent are they dependent upon oxygen or carbonic acid dissolved in water? What sort of mineral matter do they require? These are questions not yet fully answered. Attempts have been made to solve the problems by experiment, but it has been found difficult to control all the necessary conditions in the laboratory.

The optimum temperature for the development of the diatomaceæ is not known. Diatom growths have been observed at temperatures ranging from 35° to 75° F. In Lake Cochituate the average temperature of the water at the time of maximum *Asterionella* growths is not far from 50°. In some lakes it is nearer 60°. Experimental evidence upon the subject is weak, but there is reason for believing that the optimum temperature for the diatomaceæ is lower than for the green or blue-green algæ.

**Relation of Light to Diatom Growth.**—It is known that diatoms are very sensitive to light. They will not grow in the dark nor in bright sunlight. Experiments made by the author in which diatoms were allowed to grow in bottles at various depths below the surface have shown that their growth is nearly proportional to the intensity of the light. This is illustrated by Fig. 54. It will be noticed that near the surface,\* where the light

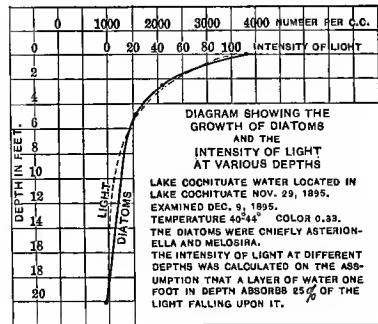

FIG. 54.

\* The growth at the depth of 6 inches was greater than at the immediate surface, where the direct sunlight was too strong.

was strong, they multiplied rapidly, but below the surface the rate of multiplication was much slower, and at a certain depth no multiplication took place. This depth-limit of growth varied according to the color and transparency of the water, being greatest in the water having the least color. In one reservoir, where the color was 86, the limit of growth was 8 ft.; in another, where the color was 60, it was 12 ft.; and in another, with a color of 29, it was 15 ft. No observations were made in colorless waters, but in them the limit of growth is as great as 25 or 50 ft., and perhaps even much more than this.

The specific gravity of diatoms plays an important part in their seasonal distribution. In absolutely quiet water most diatoms sink to the bottom, but very slight vertical currents are sufficient to prevent them from sinking. A few forms appear to have a slight power of buoyancy, and some genera are somewhat motile. Diatoms also liberate oxygen gas during growth and this tends to give them buoyancy.

Diatoms are said to be positively heliotropic, that is, they tend to move toward the light. In some of the motile forms this power is quite strong. In most of the plankton genera this power is weak. They will not move upward toward the light through any great depth of water. It is possible, however, that the power of heliotropism varies with the intensity of the light, but experimental evidence on this point is lacking.

Diatoms require air for their best development. Experiment has shown that they will not multiply in a jar where a thin layer of oil covers the surface of the water; that in cultures in jars of various shapes, the one that has the least depth of water and the greatest amount of surface exposed to the air will show the greatest multiplication; that in bottles exposed at the same depth beneath the surface of a reservoir, one with bolting-cloth tied over the mouth will show a greater development of diatoms than one tightly stoppered.

The nature of the food-material of diatoms is not well known. Observations seem to show that they require nitrogen in the form of nitrates or free ammonia (perhaps both), silica, and more or less mineral matter, such as the salts of

magnesium, calcium, iron, manganese, etc., but the amounts of these various substances required has not been determined.

The facts at hand enable one to formulate a theory for the explanation of the occurrence of maximum growths of diatoms after the periods of stagnation and during the periods of circulation.

During the periods of stagnation the lower stratum of water in a deep lake undergoes certain changes that are very pronounced if the bottom of the lake holds any accumulation of organic matter. The organic matter decays, the oxygen becomes exhausted, decomposition proceeds under the action of the anaerobic bacteria, the free ammonia increases, and other organic and inorganic substances become dissolved in the water. During the period of circulation this foul water reaches the surface, further oxidation takes place, and compounds favorable to the growth of diatoms are formed. At the same time the vertical currents carry to the surface the diatoms, or their spores, that have been lying dormant at the bottom, where they could not grow because of darkness or because of the absence of proper food conditions. Carried thus toward the surface, where there is an abundance of light, air, and nutrition, they multiply rapidly. The extent of their development depends upon the amount of food-material present, the temperature of the water, and the amount of vertical circulation. If the upper layers become stratified and the surface remains calm for a number of days the diatoms will settle in the water into a region where the light is less intense. If they sink far enough they enter a region where the light is not sufficient for their growth, and if they sink below the transition zone succeeding vertical circulation of the upper strata will not affect them. Unable to reach the surface by their own power they will sink to the bottom and remain through another period of stagnation.

In small reservoirs that are constantly supplied with water rich in diatom food and that are so shallow that even at the bottom the light is strong enough for their development, the seasonal distribution follows somewhat different laws. This

is the case in many open reservoirs where ground-water is stored.

**Seasonal Distribution of Chlorophyceæ.**—The Chlorophyceæ are most abundant in water-supplies during the summer. They are seldom found in winter. The curve showing their development is more nearly parallel with the curve showing the temperature of the water than is that of any other class of organisms. The maximum growth is usually in July or August, though some genera culminate as early as June and others as late as September or even October. The late growths are usually associated with the phenomenon of stagnation.

The optimum temperature for the different genera is not known. It seems probable that most of the common forms are able to grow vigorously between 60° and 80° F. if their food-supply is favorable and the light sufficient. It is possible for some of the green algæ to become acclimated to considerable extremes of heat or cold. *Protococcus nivalis* is found in the arctic regions, and *Conferva* has been observed in water at a temperature of 115° F.

**Seasonal Distribution of Cyanophyceæ.**—The seasonal distribution of the Cyanophyceæ is similar to that of the Chlorophyceæ, but as a rule the maximum growths occur a little later in the season. The Cyanophyceæ seem to be attuned to a slightly higher temperature than the Chlorophyceæ. They often show a great increase after a period of hot weather. *Anabæna*, *Clathrocystis*, and *Cœlosphærium* seldom give trouble unless the temperature of the water is above 70° F. This is the reason that blue-green algæ seldom give trouble in England. The surface water there seldom reaches this temperature even in summer.

*Aphanizomenon* is more independent of temperature. It apparently prefers a lower temperature than most of the Cyanophyceæ. In some ponds it is present throughout the entire year, even when the surface is frozen. On one occasion it grew under the ice in Laurel Lake, Fitzwilliam, N. H., and became frozen into the ice to such an extent that the ice-cutters were alarmed at the green color. In Lake Cochituate, *Aphanizomenon*

reaches its greatest growth in the autumn. This accounts for the maximum of the curve of Cyanophyceæ in Fig. 52 occurring in October instead of in August or September.

**Schizomycetes and Fungi.**—These forms have no well-marked periods of seasonal distribution. They are liable to be found at any season. Mold hyphæ are occasionally found at the bottom of lakes during the summer, and at the surface under the ice in winter. *Crenothrix* may be found in the stagnant water at the bottom of a deep lake during the summer, and at all depths in the autumn after the overturning of the lower layers of water. *Crenothrix* has been observed during the summer in swamps in company with *Anabæna* and other Cyanophyceæ. Attention is called to the possibility of mistaking the stems of *Anthophysa* for *Crenothrix*.

**Seasonal Distribution of Protozoa.**—The seasonal distribution of the Protozoa, taken as an entire group, is extremely variable and differs considerably in different ponds. No curve can be drawn that will represent all cases. In Lake Cochituate the curve has a major maximum in the spring, a minor maximum in the autumn, with the summer minimum lower than that in the winter. In Mystic Lake the curve has but one maximum—in the summer. These differences are due to the fact that the group of Protozoa is a broad one, and includes organisms that differ widely in their mode of life.

The Rhizopoda are found at all seasons of the year, but they are most numerous in the plankton in the autumn after the period of summer stagnation. These organisms live upon the ooze on the bottom and sides of ponds and upon twigs and aquatic plants. There they are found most abundantly in the summer. The vertical currents of the autumnal circulation scatter them through the water and cause the maximum number of floating forms to be observed during October and November. There is a minor maximum during the period of spring circulation. Some plankton forms, such as *Actinophrys*, are most abundant in summer.

Of the Flagellata, *Euglena*, *Raphidomonas* and *Phacus* are most abundant from June to September; *Trachelomonas*

is found at all seasons, but is most common in the fall after the period of summer stagnation; *Mallomonas* is found from April to October, but is usually most abundant in the autumn; *Cryptomonas* occurs in some ponds only in the late fall and winter; *Synura* and *Dinobyron* are generally most numerous in the spring and autumn, but heavy growths have been observed at all seasons; *Uroglena* seems to prefer cold weather, but vigorous growths have been noted in June.

The *Dino-flagellata*, *Glenodinium* and *Peridinium*, are usually most abundant during warm weather, but they are liable to occur at any season. *Ceratium* seldom appears before July, and it usually disappears before cold weather.

Of the *Infusoria*, most of the ciliated forms prefer warm water; *Codonella* and *Tintinnus* occur after periods of stagnation; *Vorticella* and *Epistylis* are distinctly summer organisms; and *Bursaria* and *Stentor* are also found in summer.

*Acineta* is most abundant during warm weather.

The *Protozoa* that attain their greatest development in summer are those forms that are closely allied to the vegetable kingdom, and that are perhaps more properly classed with the algæ: namely, the *Dino-flagellata* and some of the *Flagellata* that are rich in chlorophyll. A few genera that occur most abundantly in the spring and fall have a brownish-green color like that of the diatoms, which also have spring and fall maxima. The *Ciliata* that live upon decaying organic matter are attuned to a comparatively high temperature—about 75° F. This has been demonstrated by experiment, and it corresponds with the time of their observed maximum. Those *Protozoa* that exhibit a strictly animal mode of nutrition are most abundant at those seasons when there is plenty of food-material in the shape of minute organisms or finely divided particles of organic matter. This partially explains why growths are sometimes present in the winter when bacteria are numerous or after periods of stagnation when particles of organic matter from the bottom have been scattered through the water.

**Seasonal Distribution of Rotifera.**—*Rotifera* are found at all seasons of the year, but are most numerous between June and

November. In many ponds the maximum occurs in the autumn. Some genera are perennial, others are periodic in their occurrence. *Anuræa* and *Polyarthra* are found throughout the year, but their numbers rise and fall at intervals corresponding to the hatching season. *Conochilus* is often abundant in June, *Asplanchna* in July and August, and *Synchaeta* in August and September. The littoral Rotifera are most abundant during the summer.

The Rotifera feed upon the smaller microscopic organisms, and their seasonal distribution is largely influenced by the amount of this food-supply. The reactions of the Rotifera to light, temperature, etc., are not well known.

**Crustacea.**—The number of Crustacea present at different seasons varies greatly in different bodies of water. It is influenced largely by the genera that are present. Different genera vary considerably in their seasonal distribution. Some are found at all seasons, while others occur only at certain times. The perennial forms may have several maxima during the year, corresponding to the hatching of different broods. As a rule Crustacea are most numerous in the spring, but minor maxima may occur during the summer and autumn and rarely in the winter.

Temperature, food-supply, and competition are said to be the chief factors that influence the seasonal distribution of the Crustacea.

For a full discussion of the seasonal distribution of the Crustacea the reader is referred to Dr. Birge's studies of the Crustacea of Lake Mendota. The organisms are given scant attention in this book because they have but little direct significance in public water-supplies.

**Seasonal Distribution of Organisms in Lake Cochituate.**—The irregularity of the seasonal occurrence of the microscopic organisms may be seen from Fig. 55, which shows the changes that took place in the water of Lake Cochituate during a period of five years.



## CHAPTER XI

### HORIZONTAL AND VERTICAL DISTRIBUTION OF MICROSCOPIC ORGANISMS

THE plants and animals that inhabit lakes and ponds may be classified according to their habitat, but it is sufficient here to consider them either as *littoral* or *limnetic*.

The *littoral* organisms may be said to include all those forms that are attached to the shore or to plants growing on the shore, besides a host of others which, though free-swimming are almost invariably associated with the attached forms.

The *limnetic*, or *pelagic*, organisms are those that make their home in the open water. They float or swim freely and are drifted about by every current. Collectively they make up the greater part of the plankton. They include almost all the troublesome odor-producing organisms in water-supplies. In the open water, however, one often finds some of the littoral forms that have been detached from the shore and scattered through the water by the currents, or that are parasitically attached to some of the limnetic forms. Then there are organisms that may be said to be *facultative limnetic forms*, that is, they are sedentary or free-swimming at will. The true limnetic forms, however, are the most important in water-supplies, and their horizontal and vertical distributions are now to be considered.

**Horizontal Distribution.**—The horizontal distribution of the limnetic organisms is usually quite uniform within any limited area, but through the entire body of a lake the number of organisms may show considerable variation. This is quite noticeable in long, narrow reservoirs that have streams

entering at one end and discharging at the other. In such reservoirs the organisms are generally most numerous at the lower end. If, however, the water in the influx stream contains many organisms the numbers may be higher at the upper end, diminishing gradually as the water of the stream becomes mixed with that of the reservoir. Sometimes the mixing takes place slowly and the influent water passes as a current far into the reservoir. This tends to distribute the organisms in streaks. In lakes with uneven margins the horizontal distribution may vary greatly, and the number of organisms found in coves may be quite different from the number found in the open water. The horizontal distribution of diatoms is influenced to some extent by the depth of the lake. There is in Massachusetts a lake covering about 250 acres. Near one side of it there is a deep hole, that has an area of about five acres, where the stagnation phenomena are very pronounced. When the growths of diatoms occur in the spring and fall the numbers are very much higher in the vicinity of this deep hole than elsewhere in the lake.

Areas of shallow flowage exert a marked effect on the horizontal distribution of the microscopic organisms.

The wind also has a great influence, and in many bodies of water it is the controlling influence. The organisms, particularly the Cyanophyceæ, are driven in the direction of the wind and accumulate toward the lee shore.

The undertow currents also play a very important part in the horizontal distribution of the organisms. Algæ that have developed within the transition zone may by a sudden increase in the wind movement be carried into the circulating waters near the surface.

**Flotation of the Plankton.**—Some of the microscopic organisms are heavier than water, some are lighter and many have about the same specific gravity. Various means are used by the heavier organisms to float themselves.

1. Some secrete a gelatinous watery envelope which is lighter than water.
2. Some form vacuoles.

3. Some produce substances lighter than water, either
  - a.* Gas confined in the upper parts of the bodies or in special holders, or
  - b.* Oily or fatty substances.
4. Some expand their surface area and thus increase the surface friction with the water. This is accomplished in several ways.
  - a.* By the enlargement of the entire surface.
  - b.* By the formation of grooves, or markings, as in some of the diatoms.
  - c.* By the attachment of many cells to form a filament and by the development of long needle-like forms.
  - d.* By the formation of special swimming attachments, as cilia, flagella, and the antennæ and legs of crustacea.
  - e.* By the formation of colonies of organisms of considerable size.

**Vertical Distribution.**—The laws that govern the vertical distribution of the microscopic organisms are more complicated than those which govern their horizontal distribution. The latter affect the organisms mechanically; the former vitally. While their specific gravity and the vertical currents produced mechanically or thermally play an important part, the amount of food-material and dissolved oxygen and the amount of heat and light influence the very life of the organisms.

In a lake of the second order the determining factors vary at different depths and at different seasons. In the summer, for example, the conditions above the transition zone are very different from those below it. Near the surface the water is warm, the light is strong, oxygen is very abundant, and there are vertical currents. Carbonic is present early in the season. Near the bottom the water is cold, the light is weak, the oxygen may be exhausted, and the water is perfectly quiet. With these conditions chlorophyll-bearing organisms naturally thrive best above the transition zone. They seldom develop below it. Often they are found concentrated within the transition zone itself.

It has been shown by experiment that the development of diatoms is greatest near the surface and that it decreases downward as the light decreases. In nature, however, it cannot be expected that the number of diatoms in the different layers of water will follow this law closely, because the diatoms are heavy and constantly tend to sink, and because the water above the transition zone is more or less stirred up. One would expect rather to find a uniform vertical distribution above the transition zone, and below it a rapid decrease in the number of organisms. Such a distribution is common. The following instances of the vertical distribution of *Asterionella* and *Tabellaria* in Lake Cochituate may be cited in illustration; in both instances the transition zone was located between 20 and 30 ft.

VERTICAL DISTRIBUTION OF ASTERIONELLA AND  
TABELLARIA IN LAKE COCHITUATE.

Depth in Feet.	Numbers per c.c.	
	<i>Asterionella</i> . May 7, 1891.	<i>Tabellaria</i> . May 24, 1890.
Surface	3752	1886
10 ft.	3736	1448
20 "	3716	1396
25 "	—	484
30 "	1784	298
40 "	456	—
50 "	536	—
60 "	178	96

This manner of distribution is most common during periods of rapid development, when a gentle breeze is stirring. In very quiet weather and during periods of declining growth diatoms sink rapidly, and at such times they may be found most numerous at the transition zone or at the bottom. During periods of complete vertical circulation the vertical distribution may be quite uniform from top to bottom. The diatoms found at the bottom of a deep lake are usually less vigorous than those near the surface.

The Chlorophyceæ and Cyanophyceæ are much lighter in weight than the diatoms, and some of them contain oil globules and bubbles of gas. The forces tending to keep them near the surface are greater, therefore, than in the case of the diatoms. These forms are seldom found below the transition zone, and even above it show considerable variations at different depths. The Cyanophyceæ especially collect near the surface. In quiet waters they often form unsightly and ill-smelling scums. Occasional exceptions to the general rule are observed. *Microcystis*, for example, is usually more abundant in Lake Cochituate just below the transition zone than it is at the surface. On July 31, 1895, the numbers of standard units of *Microcystis* at different depths were as follows: Surface, 94; 30 ft., 342; 60 ft., 140.

It is interesting to notice that a sudden wind may affect the vertical distribution of the Cyanophyceæ and the Diatomaceæ in opposite ways. It may tend to decrease the number of blue-green algæ at the surface by preventing the formation of scums, while it increases the number of diatoms by preventing them from sinking.

The Protozoa, as a class, seek the upper strata of water. *Euglena* sometimes forms a scum upon the surface. *Uroglena*, *Synura*, etc., are often most numerous in winter just beneath the ice. The *Dino-flagellata* are distinctly surface forms. Some of the Protozoa seem to avoid direct sunlight and keep away from the upper surface of the water, though they may be very abundant at a depth of one or two feet. These organisms as elsewhere pointed out, contain chlorophyll and perhaps ought to be classed as algæ. The Ciliata and those Protozoa that have a distinctly animal mode of nutrition are more irregularly distributed through the vertical. The Rhizopoda are most abundant near the bottom.

**Concentration of Organisms in the Transition Zone.**—At times some of the microscopic organisms are more numerous in the transition than elsewhere in the vertical. An interesting illustration of this occurred in Lake Cochituate in the summer of 1896. *Mallomonas* are not ordinarily abundant

in this lake, but on June 24 they suddenly appeared just below the upper boundary of the transition zone. At the mid-depth (30 ft.) there were 116 per c.c., at the bottom there were 42 per c.c. but at the surface there were none. They developed rapidly, and on August 4 there were 3640 at the mid-depth. The growth continued until September, and during this time the largest number observed at the bottom was 276 per c.c., while above the transition zone scarcely an individual was found. On July 17 the vertical distribution was as follows:

VERTICAL DISTRIBUTION OF MALLOMONAS IN LAKE COCHITUATE, JULY 17, 1896.

Depth.	Number per c.c.	Temperature F.
Surface	0	77.3°
10 ft.	0	75.2
15 "	2	62.0
20 "	1454	47.7
25 "	794	43.7
30 "	548	43.2
40 "	112	42.5
50 "	88	41.4
60 "	64	40.8

Synura and other organisms have shown a similar vertical distribution and the phenomenon is probably more common than we used to think. Whether this concentration at the transition zone is due to food-material, to light, or to temperature is not definitely known. Mallomonas are motile and are known to be positively heliotropic. In the winter they are often numerous under the ice. It is possible that they have a low temperature attunement, and that in the instance above cited they collected as near the surface as their temperature attunement would permit. This would accord with the fact that they are most numerous in the spring and fall. It is possible that the dissolved gases are a factor in the problem and also the increased density and viscosity of the water at lower temperatures. Supersaturation of the water with oxygen at the transition zone has already been alluded to.

Another explanation also suggests itself. The organisms most frequently found concentrated at the transition zone,

partake of the animal nature, that is *Synura*, *Dinobryon*, *Mallomonas* and the like are classed by Calkins among the Protozoa. Presumably they depend, in part at least, upon other organisms, as food—as for example, bacteria. It is possible that in the process of sedimentation the bacteria in a lake, are temporarily checked in their fall by reason of the greater density and viscosity of the colder water at the transition zone, and that the Protozoa congregate there to devour them; while the crustacea congregate there to devour the Protozoa. As the Protozoa mentioned also contain chlorophyll, the process of phytosynthesis also takes place.

This explanation would not apply to the blue-green algæ, one of which, *Aphanizomenon*, is often found concentrated in the transition zone.

Rotifera and Crustacea are often numerous above the transition zone, but on the other hand, they are commonly more numerous in or below it. Apparently their food-supply is a controlling factor. During the winter they are sometimes abundant at the bottom. Different genera react differently to light, and heat. Some of them show a slight daily migration toward the surface at night, and away from the surface in the daytime.

The Schizomycetes are usually more abundant at the bottom of a pond than at the surface. Mold hyphæ are often numerous in winter just under the surface of the ice.

**Adaptation of Organisms to Changed Viscosity of Water.**—Although the density of water changes but slightly with variations in temperature its viscosity changes greatly. At 25° C. (77° F.) the viscosity of water is only one-half of what it is at 0° C. (32° F.), consequently the tendency of organisms to sink at 25° is about twice as great as at 0° C. Unless the organisms can adapt themselves to this change and in some way increase their buoyancy during warm weather they will sink to a colder stratum and perhaps even to the bottom. Possibly slight changes in the temperature of the water in the upper strata between day and night may be an important factor in the vertical migration of certain crustacea, the organisms

rising to the surface as the water cools at night and sinking to lower strata as the sun warms the water.

Dr. C. Wesenberg-Lund claims that certain organisms adapt themselves to changes in viscosity, by expanding during warm

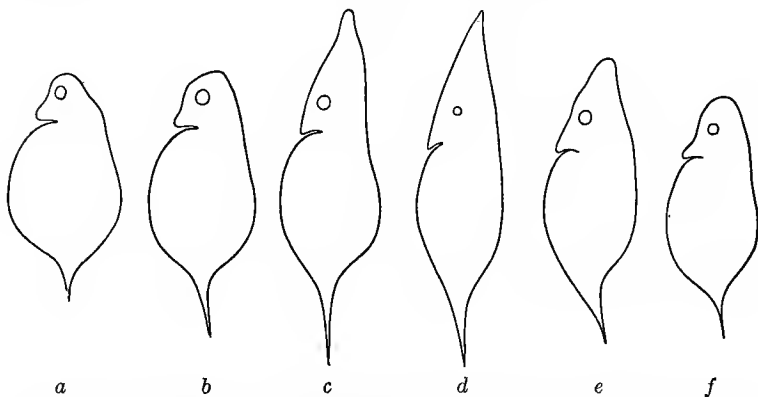

FIG. 56.—*Hyalodaphnia*. Showing changes of shape supposed to adapt their flotation to different densities and viscosities of water. *a*, *b*, and *f* are winter forms; *c*, *d*, and *e* are summer forms.

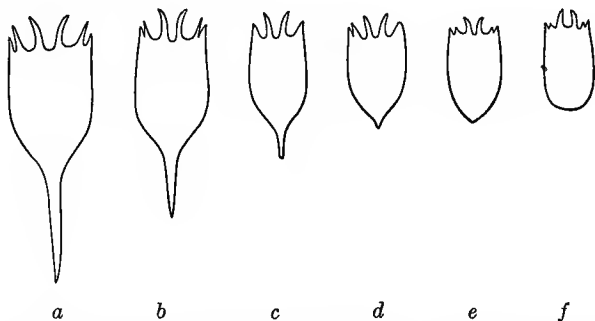

FIG. 57.—Seasonal Changes in the Shape of *Anuræa*. *a*, *b*, and *c*, summer forms; *d*, *e*, and *f*, winter forms.

weather, thus increasing the surface exposed to the water, or by changing their shape or the location of their center of gravity. This theory is interesting, but it has not been fully demonstrated. *Daphnia hyalina* is said to be round-headed during the winter but point-headed during the summer; *Bosmina coregoni* enlarges in summer; *Asplanchna priodonta* becomes elongated;

while *Ceratium hirundinella* grows an extra horn that increases its floating power. *Tabellaria* increase the number of cells in their colonies and thus attain greater flotation and doubtless other diatoms do the same. These changes take place at a temperature of 12 to 16° C. (47.6 to 60.8° F.), that is during May and June, and again in the autumn; and the change is not gradual but takes place in the course of two or three weeks.

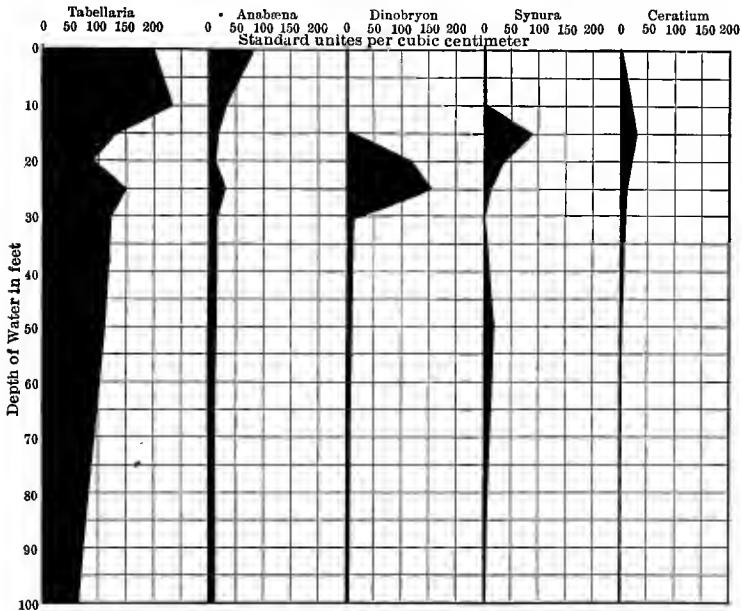

FIG 58.—Vertical Distribution of Organisms in McGregor Lake, near Ottawa, Ontario. July 12, 1911.

Wesenberg-Lund has also shown that these variations are regional as well as seasonal. There is a gradual decrease in volume of many well known plankton forms from the south to the north, and in regions where there is the greatest range of temperature there is also the greatest seasonal variation. The low temperature forms of the plankton tend to uniformity, but the high temperature forms in different lakes.

**Studies at McGregor Lake near Ottawa.**—Fig. 58 shows the distribution of certain organisms in McGregor Lake situated

in the Province of Ontario a few miles north of Ottawa. Here in July, 1911, it was found that the diatom, *Tabellaria* and the blue-green algæ, *Anabæna*, were most abundant near the surface, but that *Dinobryon* and *Synura* were much more abundant in the transition zone. The studies in this lake were of especial interest by reason of its high latitude. The full report by the author was published in the Annual Report of the Provincial Board of Health of Ontario, Canada for the year 1911.

**Average Conditions at Different Depths.**—In spite of the tendencies of the organisms to choose their favorite habitat in a body of water, the mechanical effects of winds, currents, gravity, and other factors are so great that in most ponds and reservoirs used for water-supply, except in very deep ones, the average number of organisms of all kinds through the year does not vary much at different depths. This is illustrated by the following table:

TABLE SHOWING THE RELATIVE NUMBER \* OF MICROSCOPIC ORGANISMS OF ALL KINDS AT THE SURFACE, MID-DEPTH, AND BOTTOM OF THE RESERVOIRS OF THE BOSTON WATER WORKS.

Locality.	Depth.	1890.	1891.	1892.	1893.	1894.	1895.	1896.
Lake Cochituate	Surface	454	736	523	389	416	355	507
	30 ft.	304	569	528	336	365	373	657
	60 ft.	357	650	626	316	309	353	544
Sudbury Reservoir No. 2	Surface	68	322	268	116	45	61	87
	13 ft.	80	273	256	98	49	56	120
	25 ft.	64	268	229	98	33	47	78
Sudbury Reservoir No. 3	Surface	152	277	514	381	289	621	524
	15 ft.	182	267	523	303	194	543	467
	30 ft.	131	323	481	311	179	485	498
Ashland Reservoir	Surface	50	129	269	112	28	57	94
	20 ft.	38	95	268	84	20	35	108
	40 ft.	25	83	235	66	20	25	106
Hopkinton Reservoir	Surface					87	105	189
	25 ft.					52	58	118
	50 ft.					72	53	104

\* For the years 1890 to 1893 the results were given in Number of Organisms per c.c. Since Jan. 1, 1893, the results have been given in Number of Standard Units per c.c. (One standard unit equals 400 square microns.)

The vertical distribution varies at different seasons, as the following table illustrates:

TABLE SHOWING THE RELATIVE NUMBER OF ORGANISMS (STANDARD UNITS) PER C.C. AT THE SURFACE, MID-DEPTH, AND BOTTOM OF THE RESERVOIRS OF THE BOSTON WATER WORKS DURING 1895.

Locality.	Depth.	Month.												Mean.
		January.	February.	March.	April.	May.	June.	July.	August.	September.	October.	November.	December.	
Lake Cochituate.	Surface.	255	34	10	97	188	437	480	248	137	450	1159	762	355
	30 ft.	407	21	23	109	149	188	539	329	193	400	1199	921	373
	60 ft.	422	232	55	101	133	188	503	290	53	252	1198	808	353
Sudbury Reservoir No. 2.	Surface.	6	8	6	49	56	109	163	152	82	72	15	18	61
	13 ft.	6	7	18	25	59	76	195	108	93	53	14	17	56
	25 ft.	4	7	17	22	47	63	160	88	74	49	22	9	47
Sudbury Reservoir No. 3.	Surface.	13	3	14	62	375	787	1197	1675	1778	1227	266	53	621
	15 ft.	18	1	14	46	260	768	1072	1134	1813	1161	253	34	543
	30 ft.	47	4	13	57	235	597	633	1146	1487	1342	222	37	485
Ashland Reservoir.	Surface.	78	74	10	27	79	76	123	75	30	45	40	22	57
	20 ft.	18	19	5	15	37	47	43	78	29	55	37	19	35
	40 ft.	13	19	18	12	21	41	48	38	7	33	21	26	25
Hopkinton Reservoir.	Surface.	41	50	36	64	91	193	203	91	243	186	41	13	105
	25 ft.	28	10	4	57	42	61	46	65	130	190	56	9	58
	50 ft.	4	5	21	76	51	39	18	47	83	214	60	16	53

A further analysis of the results at Lake Cochituate shows the vertical distribution of the different classes of organisms to be as follows:

RELATIVE NUMBER OF ORGANISMS (STANDARD UNITS) PER C.C. AT THE SURFACE AND BOTTOM OF LAKE COCHITUATE.

AVERAGE FOR THE YEAR 1895.

	Diatomaceæ.	Chlorophyceæ.	Cyanophyceæ.	Protozoa.	Rotifera.	Miscellaneous.	Total.
Surface.....	144	79	108	17	3	4	355
Bottom, 60 ft..	160*	16	67	10	1	99†	353

\* If the dead and empty cells were excluded this figure would be much lower.

† Chiefly Crenothrix.

## CHAPTER XII

### ODORS IN WATER-SUPPLIES

THE senses of taste and odor are distinct, but they are closely related to each other. There are some substances, like salt, that have a taste but no odor, and there are other substances, like vanilla, that have a strong odor but no taste. Many of the so-called tastes are really odors, the gas or vapor given off by the substance tasted reaching the nose not only through the nostrils but through the posterior nares. Thus an odor "tasted" is often stronger than an odor smelled.

Chemically pure water is free from both taste and odor. Water containing certain substances in solution, as sugar, salt, iron, may have a decided taste but no odor. Such taste producing substances are met with in mineral waters or in brackish or chalybeate waters, but as a rule they are not offensive and they seldom affect large bodies of water. Most of the bad tastes observed in drinking water are due not to inorganic but to organic substances in solution or suspension and to microscopic organisms. These produce odors as well as tastes. The subject may be pursued therefore from the standpoint of odor alone, though in many instances the best way to observe the odor of the water is to taste it.

Water taken directly from the ground and used immediately is usually odorless. In certain sections of the country deep well water has a sulphurous odor. Contaminated well water or water drawn from a swampy region may be somewhat moldy or unpleasant.

Almost all surface-waters have some odor. Many times it is too faint to be noticed by the ordinary consumer, though it can be detected by one whose sense of smell is carefully

trained. On the other hand, the water in a pond may have so strong an odor that it is offensive several hundred feet away. Between these two extremes one meets with odors that vary in intensity and in character, and that are often the source of much annoyance and complaint.

**Classification of Odors**—It is difficult to classify the odors of surface-waters on a satisfactory basis, but they fall into three general groups: 1. Odors caused by organic matter other than living organisms. 2. Odors caused by the decomposition of organic matter. 3. Odors caused by living organisms.

**Odors Caused by Organic Matter.**—The odors caused by organic matter other than living organisms may be included under the general term *vegetable*. They vary in character in different waters and at different seasons. It is difficult to find terms that will describe them exactly. It is seldom that two observers will agree as to the most appropriate descriptive adjective. To one person the odor of a water may be *straw-like*, to another *swamp-like*, to another *peaty*. This is due to the fact that the sense of smell in man is not well cultivated. In practice, therefore, it has become customary among analysts to use the general term *vegetable* instead of the terms *straw-like*, *swamp-like*, *marshy*, *peaty*, *sweetish*. The intensity of an odor may be indicated by using the prefixes *very faint*, *faint*, *distinct*, *decided*, *very strong*. A better method, however, is to use numerical prefixes, which may be approximately defined as shown in table on p. 188. According to this method the expression “3 f” would indicate a “distinct fishy odor,” “2 v” a “faint vegetable odor,” etc. The reader will understand that the above definitions are far from exact, and that the intensity of odors varying in character cannot be well compared. A *faint fishy* odor, for example, might often attract more attention than a *distinct vegetable* odor. Heating a water usually intensifies its odor. In the laboratory the “cold odor” is observed by shaking a partly filled bottle of the water and immediately removing the stopper and applying the nose. The “hot odor” is obtained by heating a portion of the water in a tall beaker covered with a watch-glass to a point just short of

boiling. When sufficiently cool the cover is slipped aside and the observation made. A water that has a *faint* odor when cold may have a *distinct* odor when hot.

Numerical Value.	Term.	Approximate Definition.
0	None.	No odor perceptible.
1	Very Faint.	An odor that would not be ordinarily detected by the average consumer, but that could be detected in the laboratory by an experienced observer.
2	Faint.	An odor that the consumer might detect if his attention were called to it, but that would not otherwise attract attention.
3	Distinct.	An odor that would be readily detected and that might cause the water to be regarded with disfavor.
4	Decided.	An odor that would force itself upon the attention and that might make the water unpalatable.
5	Very Strong.	An odor of such intensity that the water would be absolutely unfit to drink (a term to be used only in extreme cases).

Most of the *vegetable* odors are caused by vegetable matter in solution. Brown-colored waters invariably have a *sweetish-vegetable* odor, and the intensity of the odor varies almost directly with the depth of the color. Both color and odor are due to the presence of certain glucosides, of which tannin is an example, extracted from leaves, grasses, mosses, etc. In addition to the odor, these substances have a slight astringent taste. Colorless waters containing organic matter of other origin may have *vegetable* odors, but they are usually less *sweetish* and more *straw-like* or *peaty*. Akin to the *vegetable* odors are the *earthy* odors caused by finely divided particles of organic matter and clay. The two odors are often associated in the same sample.

**Odors of Decomposition.**—Odors produced by the decomposition of organic matter in water are not uncommon. They

are described, somewhat imperfectly, by such terms as *moldy*, *musty*, *unpleasant*, *disagreeable*, *offensive*. An *unpleasant* odor is produced when the vegetable matter in water begins to decay. It may be said to represent the first stages of decomposition. As decomposition progresses the *unpleasant* odors become *disagreeable*, and then *offensive*. It is seldom that the decomposition of vegetable matter in water produces odors worse than *decidedly unpleasant*. The *disagreeable* odors usually can be traced to decaying animal matter, and, as a rule, *offensive* odors are observed only in sewage or in grossly polluted water. The terms *moldy* and *musty* are more specific than the terms *unpleasant*, *disagreeable*, and *offensive*, but they are difficult to define. They are quite similar in character, but the *musty* odor is more intense and is usually applied only to sewage-polluted water. The *moldy* odor suggests a damp cellar, or perhaps a decaying tree-trunk in a forest. The bacteriologist will recognize this odor as similar to that given off by certain bacteria growing on nutrient gelatine.

The odors of decomposition naturally are associated with the odors of the other groups, and one often finds it convenient to use such expressions as *distinctly vegetable and faintly moldy*, i.e., "3v+2m," or *decidedly fishy and disagreeable*, i.e., "4f+4d."

**Odors Caused by Organisms.**—The odors of drinking water due to the presence of living organisms are the most important because of their common occurrence, because of their offensive nature, and because they affect large bodies of water. It is only within recent years that these odors have been well understood, and even now there is much to be learned about the chemical nature of the odoriferous substances and their relation to the life of the organisms. At one time it was supposed that it was only by decay that the organisms became offensive. It is now a well-established fact that many living organisms have an odor that is natural and peculiar to them, just as a fresh rose or an onion has a natural and peculiar odor. It has been found, also, that in most cases—and it may be true in all cases—the odor is produced by compounds analogous

to the essential oils. In some cases the oily compounds have been isolated by extraction with ether or gasoline. Odors due to these oils have been called "odors of growth" because the oils are produced during the growth of the organisms. The oil globules may be seen in many genera if they are examined with a sufficiently high power. They are usually most numerous in the mature forms and are often particularly abundant just before sporulation or encystment. The production of the oil represents a storing-up of energy. The odors have been called "odors of disintegration," because they are most noticeable when the breaking up of the organism causes the oil globules to be scattered through the water. It is sufficient, however, to call them the "natural odors" of the organisms, to distinguish them from the very different odors produced by their decomposition.

It was stated in Chapter VI that the microscopic organisms are not found in ground-waters (except when stored in open reservoirs) or streams in sufficient abundance to cause trouble. It is in the quiescent waters of ponds and lakes and reservoirs that they develop luxuriantly, and it is to the reservoir that one should look first when investigating the cause of an odor in a public water-supply.

The littoral organisms found on the sides of reservoirs include the flowering aquatic plants, the Characeæ and the filamentous algæ, of the vegetable kingdom and the fresh-water sponge, Bryozoa, etc., of the animal kingdom. The effect which they exert on the odor of a water is difficult to determine because they are seldom found in a reservoir where the floating microscopic organisms are wholly absent. In many cases where a peculiar odor of a water has been charged to some of these littoral forms, subsequent investigation has made it probable that the odor was really caused by limnetic organisms that had been overlooked in the first instance.

Speaking generally it may be said that in reservoirs that are large and deep the organisms attached to the shores produce little or no effect on the odor of the water; and that in small shallow reservoirs where the aquatic vegetation is thick

they do not impart any characteristic "natural" odor, but may produce a sort of vegetable taste and a disagreeable odor due to decomposition.

**Odors of Littoral Plants.**—Some of the littoral aquatic plants, such as *Myriophyllum* and a number of the filamentous algæ, possess a natural odor that is strongly "vegetable" and, at times, almost fishy; but the odor is obtained only when the plants are crushed or when fragments are broken off and scattered through the water. Under ordinary conditions of growth in a reservoir this does not happen and therefore no odor is imparted to the water except through decomposition.

There are on record some apparent exceptions to the rule that the attached growths cause no odor. Hyatt described a growth of *Meridion circulare* at the headwaters of the Croton River, in 1881, that was supposed to have affected the entire supply of New York City; Rafter has connected odors with *Hydrodictyon utriculatum* and other Chlorophyceæ; Forbes investigated a water-supply where a growth of *Chara* was thought to be the cause of a bad odor; Tighe has also reported a troublesome growth of *Chara* at Holyoke. Weston has stated that serious trouble was caused in Henderson, N. C., by an extensive growth of *Pectinatella*. All of these cases where odors in water-supplies have been attributed to certain littoral organisms lack corroboration.

The author once examined a reservoir where a mass of *Melosira varians* several feet thick covered the slopes to a considerable depth. A severe storm tore away the fragile filaments, and masses of *Melosira* passed into the distribution-pipes and caused a noticeable vegetable and oily odor in the water.

**Cucumber Taste in Farm Pond.**—In connection with the relation of the littoral organisms to odors in water-supplies some reference should be made to the "cucumber taste" thwt has been a frequent cause of complaint against the Boston water-supply. In 1881 the trouble was very severe. The water had a decided odor of cucumbers, which was intensified at times to a "fish-oil" odor. Heating made the odor very strong and

offensive. A noted expert made an examination and concluded that the seat of the trouble was in Farm Pond—one of the sources of supply. This pond was so situated that all the water of the Sudbury system passed through it on its way to the city. Chemical analysis of the water and microscopical examination of the mud failed to reveal the cause of the odor. It was found, however, that fragments of fresh-water sponge (*Spongilla fluviatilis*) were constantly collecting on the screens and that these had the “cucumber odor.” It was decided therefore that the fresh-water sponge was the cause of the odor. The conclusion was quite generally accepted and the report has been quoted extensively.

At that time some water experts disagreed with this opinion. They claimed that the amount of sponge found in the pond was not sufficient to produce the odor. In the light of modern microscopical examinations we have come to believe that the dissenters were right and that the fresh-water sponge was not the cause of the cucumber odor. The author took masses of *Spongilla* and allowed them to rot in a small quantity of water till the odor was unbearable. This water was then diluted with distilled water to see how large a mass of water the decayed sponge would affect. It was found that with a dilution of 1 to 50,000 there was no perceptible odor. At this rate it would take a mass of sponge several feet thick over the entire bottom of Farm Pond to produce an odor as intense as that observed in 1881. Moreover the odor produced by decaying sponge is not the “cucumber odor,” although similar to it.

There is good reason to believe that the cucumber odor observed in 1881 was due to *Synura*. One need not dispute the observation that the sponge that collected on the Farm Pond screens had the cucumber odor, for no doubt the sponge was covered with *Synura*, as it is often covered with other organisms. It is not surprising, either, that the *Synura* should have been overlooked in the water, because the organism disintegrates readily and a comparatively small number of colonies is able to produce a considerable odor. The times

of the occurrence of the odor—namely, in the spring and autumn—are worth noting, as they correspond with the seasons when *Synura* grows best and when it is most commonly found.

In February, 1892, the cucumber taste again appeared in the Boston water. This time it was definitely traced to *Synura* that was growing in the water just under the ice in Lake Cochituate. Since then it has reappeared at intervals in other parts of the supply—notably in Basin 3 and Basin 6. It has been found that 5 or 10 colonies per c.c. are sufficient to cause a perceptible odor.

*Synura* has often been the cause of bad odors in the Croton supply of New York.

**Odors of the Plankton.**—The floating microscopic organisms, or the plankton, are responsible for most of those peculiar nauseating odors that are the cause of complaint in so many public water-supplies. In most, if not in all, cases the odor is due to the presence of an oily substance elaborated by the organisms during their growth. This has been proved by long-continued observations and experiments, during the course of which the following facts have been noted:

The odors referred to vary in character. They are difficult to describe, but they can be readily identified. Particular odors are associated with particular organisms. If an organism is present in sufficient numbers its particular odor will be observed; if it is not present in sufficient numbers its odor will not be observed. Further, with some exceptions the intensity of the odor varies with the number of organisms present. If water that contains an organism which has a natural odor is filtered through paper, the odor of the filtered water \* will be much fainter than before, and the filter-paper on which the organisms remain will have a strong odor. If the organisms are concentrated by the Sedgwick-Rafter method, the concentrate will have a decided taste and odor. If these organisms are placed in distilled water, the water will acquire

\* In some cases the odoriferous substances from the organisms pass through the filter, and the disintegration of the organisms gives the filtered water an increased odor over the unfiltered water.

the odor of the original water. Thus, the relation between particular odors and particular organisms has been well established. Indeed, in the absence of a microscopical examination, experienced observers are often able to tell the nature of the organisms present by a simple observation of the odor.

That the odors are not due to the decomposition of the organism is proved by the character of the odors themselves and by the fact that they are not accompanied necessarily by large numbers of bacteria or by the presence of free ammonia or nitrites. Further, when the organisms do decay, the bacteria increase in number and the odor of the water changes in character.

The natural odor is given off by some substance inside the organism, and when this substance becomes liberated the odor is more easily detected. The odor is intensified by heating, by mechanical agitation, by pressure, and by change in the density of the water containing the organisms. Many of the odor-producing organisms are very delicate. Heating breaks them up and drives off the odoriferous substances. The flow of water through the pipes of a distribution system is sufficient to cause the disintegration of many forms, and it is a matter of common observation that in such cases the odor of a water at the service-taps is more pronounced than at the reservoir. If the density of a water is increased by adding to it some substance, such as salt, the organisms may become distorted if not actually broken up. This causes an intensification of their odor. Increased pressure leads to the same result.

The natural odor of the organisms is due to some oily substance analogous to those substances found in higher plants and animals, and that give the odor to the peppermint and the herring. The fact was noted long ago that the addition of salt to water that was affected with certain odors developed an oily flavor. Many of the odors caused by organisms are of a marked oily nature. The oil globules in these organisms may be observed with the microscope. The number of oil globules varies according to the age and condition of the

organisms, and the intensity of the odor varies with the number of oil-globules present. Finally, the oily substances have been extracted from the organisms and it has been found that they possess the same odor as that observed in the water containing them.

**Odors of Essential Oils.**—A series of experiments was made at one time to show that the amount of oil present in the organisms was sufficient to account for the odors observed in drinking water. Some of the familiar essential oils, such as oil of peppermint, oil of clove, cod-liver oil, etc., were diluted with distilled water, and the amount of dilution at which the odor became unrecognizable was noted. The oil of peppermint was recognized when diluted 1: 50,000,000; the oil of clove, 1: 8,000,000; cod-liver oil, 1: 1,000,000; etc. The odor of kerosene oil could not be detected when diluted 1: 800,000. The amount of oil present in water containing a known number of organisms was estimated for comparison. It was found that in water containing 100 colonies of *Synura* per c.c. the dilution of the *Synura* oil was 1: 25,000,000; and that in a water with 50,000 *Asterionella* per c.c. the dilution was only 1: 2,000,000. Thus, the production of the odor by the oil is quite within the range of possibility. An interesting fact brought out by the experiments was that the odor of the oils varied with different degrees of dilution not only in intensity but in character. On one occasion seven people out of ten who were asked to observe the odor of very highly diluted kerosene oil declared that it smelled like "perfumery." This variation of the character of the odor with its intensity is important to notice, as it accounts for the different descriptions of the same odor in a water-supply at different times and by different people.

The nature of the odoriferous oils or oily substances is not well known. Calkins, who isolated the odoriferous principle of *Uroglena* with gasoline and ether, describes it as being similar to the essential oils. It was non-volatile at the temperature of boiling water. Jackson and Ellms extracted a similar substance from *Anabæna* with gasoline. On standing it oxidized and became resinous. It contained needle-like

crystals. Experiments by the author have shown that the oils of *Asterionella* and *Mallomonas* are quite similar in character.

Most, if not all, of the organisms produce oil during their growth to a greater or less degree. In many cases it is quite odorless. Water is often without odor even when large numbers of organisms are present. This is either because the organisms have not produced oil, or because the oil is odorless. Sometimes water rich in organisms will have an oily flavor with no distinctive odor. This is true in the case of some species of *Melosira*. Many organisms impart a vegetable and oily taste, without a distinctive odor. This is true of *Synedra pulchella* and *Stephanodiscus*. There are, moreover, microscopic organisms that produce oils that have a distinctive odor, but that occur in drinking water in such small numbers that the odor is not detected. The organisms that have a distinctive odor and that are found in large numbers are comparatively few. Not more than twenty-five have been recorded and only about half a dozen have given serious trouble. More extended observations may lengthen this list.

**Odors of Particular Organisms.**—The distinctive odors produced by these organisms may be grouped around three general terms—*aromatic*, *grassy*, and *fishy*—and for convenience they may be tabulated as in the table on page 197.

**Aromatic Odors.**—The aromatic odors are due chiefly to the Diatomaceæ. The strongest odor is that produced by *Asterionella*. The character of this odor changes with its intensity. When few organisms are present the water may have an undefinable *aromatic* odor; as they increase the odor resembles that of a *rose geranium*; when they are very abundant the odor becomes *fishy* and *nauseating*. The other diatoms given in the table produce the aromatic odor only when present in very large numbers. There are two protozoa that have an aromatic odor. The odor of *Cryptomonas* is *sweetish* and resembles that of the *violet*. The odor of *Mallomonas* is similar to that of *Cryptomonas*, but when strong it becomes *fishy*.

Group.	Organism.	Natural Odor.
AROMATIC • ODOR.	DIATOMACEÆ	
	Asterionella	Aromatic—geranium—fishy.
	Cyclotella	Faintly aromatic.
	Diatoma	Faintly aromatic.
	Meridion	Aromatic.
	Tabellaria	Aromatic.
	PROTOZOA	
	Cryptomonas	Candied violets.
	Mallomonas	Aromatic—violets—fishy.
GRASSY ODOR.	CYANOPHYCEÆ	
	Anabæna	Grassy and moldy—green-corn—nasturtiums, etc.
	Rivularia	Grassy and moldy.
	Clathrocystis	Sweet, grassy.
	Cœlosphærium	Sweet, grassy.
	Aphanizomenon	Grassy.
FISHY ODOR.	CHLOROPHYCEÆ	
	Volvox	Fishy.
	Eudorina	Faintly fishy.
	Pandorina	Faintly fishy.
	Dictyosphærium	Faintly fishy.
	PROTOZOA	
	Uroglena	Fishy and oily.
	Synura	Ripe cucumbers—bitter and spicy tatse.
	Dinobryon	Fishy, like rockweed.
	Bursaria	Irish moss—salt marsh—fishy.
	Peridinium	Fishy, like clam-shells.
Glenodinium	Fishy.	

**Grassy Odors.**—The grassy odors are produced by the Cyanophyceæ. *Anabæna* is the most important organism of this class. There are several species that have slightly different odors. The *grassy* odor is usually accompanied by a *moldy* odor, which is probably due to decomposition, as this organism decays rapidly. When very strong the odor of *Anabæna* much resembles *raw green-corn*, or even a *nasturtium* stem. The prevailing odor, however, is *grassy*, i.e. the odor of freshly cut grass. The other blue-green algæ have odors that may be called *grassy*, but they are less distinctive than in the case of *Anabæna*.

**Fishy Odors.**—The *fishy* odors are the most disagreeable of any observed in drinking water. That produced by *Uroglena* is per-

haps the worst. It is quite common. Water rich in *Uroglena* has an odor not unlike that of *cod-liver oil*. The odor of *Synura* is almost as bad and almost as common. It resembles that of a *ripe cucumber*. *Synura* also has a distinct bitter and spicy taste. It "stays in the mouth" and is most noticeable at the back part of the tongue. *Glenodinium* and *Peridinium* both produce fishy odors. The latter somewhat resembles *clamshells*. *Dinobryon* has a fishy odor and suggests *sea-weed*. The odor of *Bursaria* is said to be like that of *Irish moss*. It also reminds one of a *salt marsh*. With certain degrees of dilution some other Protozoa have the salt-marsh odor, reminding one of the sea. Fishy odors are said to be produced by *Volvox*, *Eudorina*, and *Pandorina*. These Chlorophyceæ are sometimes classed with the Protozoa, so that it may be said in a general way that the fishy odors are produced by microscopic organisms belonging to the animal kingdom.

**Odors of Decomposition.**—Some of the microscopic organisms have distinctive odors of decomposition. The Cyanophyceæ when decaying give a "pig-pen" odor. *Beggiatoa* and some species of *Chara* give the odor of sulphureted hydrogen. All the odors given off by the decomposition of microscopic organisms are offensive. They are particularly so when the organisms contain a high percentage of nitrogen. Jackson and Ellms, in an interesting study of the decomposition of *Anabæna circinnalis*, found that that organism contained 9.66 per cent of nitrogen. They found that the "pig-pen" odor was due "to the breaking down of highly organized compounds of sulphur and phosphorus and to the presence of this high percentage of nitrogen. The gas given off during decomposition was found to have the following composition:

Marsh-gas . . . . .	0.8%
Carbonic acid . . . . .	1.5%
Oxygen . . . . .	2.9%
Nitrogen . . . . .	12.4%
Hydrogen . . . . .	82.4%
	<hr/>
	100.0%

The gas that remained dissolved in the water containing the Anabæna was practically all CO<sub>2</sub> and represented a large percentage of the total gas produced. ”

Besides the odors above described, water-supplies sometimes become affected with what have been called “chemical odors”—such as those of carbolic acid, creosote, tar, etc. They can be traced usually to some pollution by manufacturing waste, though a vigorous decomposition of organic matter has been known to give an odor resembling carbolic acid. Similar odors are sometimes caused by the coating on the inside of new distribution-pipes.

#### Occurrence of Different Odors in Massachusetts Reservoirs.

—The extent to which water-supplies are afflicted with odors was well shown by the investigations of the Massachusetts State Board of Health. Out of 71 water-supplies taken from ponds and reservoirs, 45, or 63 per cent, were found to have given trouble from bad tastes or odors, and about two thirds of these had given serious trouble. Calkins has stated that in 1404 samples from surface-water supplies in Massachusetts odors were observed as follows:

Odor.	Per Cent of Samples Affected.
No odor.....	20
Vegetable.....	26
Sweetish.....	7
Aromatic.....	6
Grassy.....	15
Fishy.....	3
Moldy.....	10
Disagreeable.....	6
Offensive.....	7

The intensity of these odors was not stated. Many of them probably were not strong enough to cause complaint.

It must not be inferred from this that Massachusetts is more afflicted in her surface-water supplies than other sections of the country. The same troubles are observed almost everywhere. It is only because the Massachusetts supplies have been more carefully studied than elsewhere that attention has

been drawn to them. In a previous chapter it was stated that the microscopic organisms are widely distributed both in this country and abroad. Wherever they are found in abundance they must inevitably affect the odor of the water.

**Are Algæ Injurious?**—The question is often asked, “Are growths of organisms such as *Asterionella*, *Synura*, etc., injurious to health?” This cannot be answered authoritatively, but from the data at hand it is believed that such organisms are not injurious—certainly not to persons in good health. The actual amount of solid matter contained in the organisms is much smaller than might be supposed. For example, it has been calculated that the weight of one *Asterionella* is .000000004 gram. A growth of 100,000 *Asterionella* per c.c. would render a water unfit to drink because of its odor, yet a tumblerful of such water would contain but eight milligrams of solid matter, and only one-half of this would be organic matter. It is almost inconceivable that such a small amount of organic matter could cause trouble unless some poisonous principle were present, and so far as is known no such substance has been found. The alleged cases of poisonous algæ rest upon too uncertain evidence to be received as facts.

Nevertheless there is some reason to believe that people accustomed to drinking water free from organisms may be subjected to temporary intestinal disorders when they begin to drink water rich in microscopic organisms—just as people are affected by changing from a hard to a soft water and *vice versa*. It is possible that with young children and invalids such disorders may be more common than has been supposed. Decomposition of the organisms by bacterial action may possibly contribute to intestinal disorders.

Yet, whether harmful or not the presence of large numbers of organisms in a public water-supply is most objectionable.

**Value of Pure Water.**—In his little book entitled “The Value of Pure Water” the author has attempted to express in terms of money the value to a community of a supply of clean water over a water that is unattractive by reason of color, turbidity and the presence of algæ. The following paragraphs are taken from this work.

**Attractiveness.**—The analytical determinations which relate to the general attractiveness of a water are those of taste, odor, color, turbidity, and sediment. As these quantities increase in amount, the water becomes less attractive for drinking purposes, until finally a point is reached where people refuse to drink it. In order to use these results in a practical way, it is necessary to combine them so as to obtain a single value for the physical characteristics or, as they say abroad, for the “organoleptic” quality of the water. An attempt has been made by the author to obtain what may be termed an æsthetic rating of the water, and the result is shown in the diagram on page 202.

This diagram, it should be said, is based almost entirely upon estimates and very little upon statistical data. It rests upon the assumption that people differ in their sensibilities or their æsthetic feelings as to the use of water. Some persons are much more fastidious than others in regard to what they drink. A water which would be shunned by one person, even though he were thirsty, might be taken by another with apparent relish. As a rule, people are more fastidious about the odor of water and the amount of coarse sediment which it contains than they are about its color and turbidity. This is perhaps natural, as a bad odor suggests decay, and decay is instinctively repugnant. Often, however, people do not discriminate between odors which are due to decomposition and those which are not. Habit and association have much to do with a person's views as to the attractiveness of water. In New England, where the clear trout brooks run with what Thoreau called “meadow tea,” few people object to a moderate amount of color, while they do object to a water which is very turbid. In the Middle West, where all the streams are muddy, it is the unknown colored waters which are disliked. People who are accustomed to well-water object to both color and turbidity. With most people a fine turbidity, such as is produced by minute clay particles, is less a subject of complaint than an equal turbidity produced by comparatively coarse sediment. In the diagram an attempt has been made to reconcile these different points of view, so as to put them, as well as may be, on the same footing. In this connection several series of comparisons were made.\* Turbid waters were viewed by a group of Western people, who made some comparisons with colored and turbid waters, while colored waters were viewed by a group of students in New York, and *vice versa*.

\* Acknowledgments are due to Mr. J. W. Ellms, of Cincinnati, Ohio, and Mr. Andrew Mayer, Jr., of Brooklyn, N. Y.

The abscissæ of the diagram represent turbidity, color, and odor, as given in the ordinary water-analysis. The ordi-

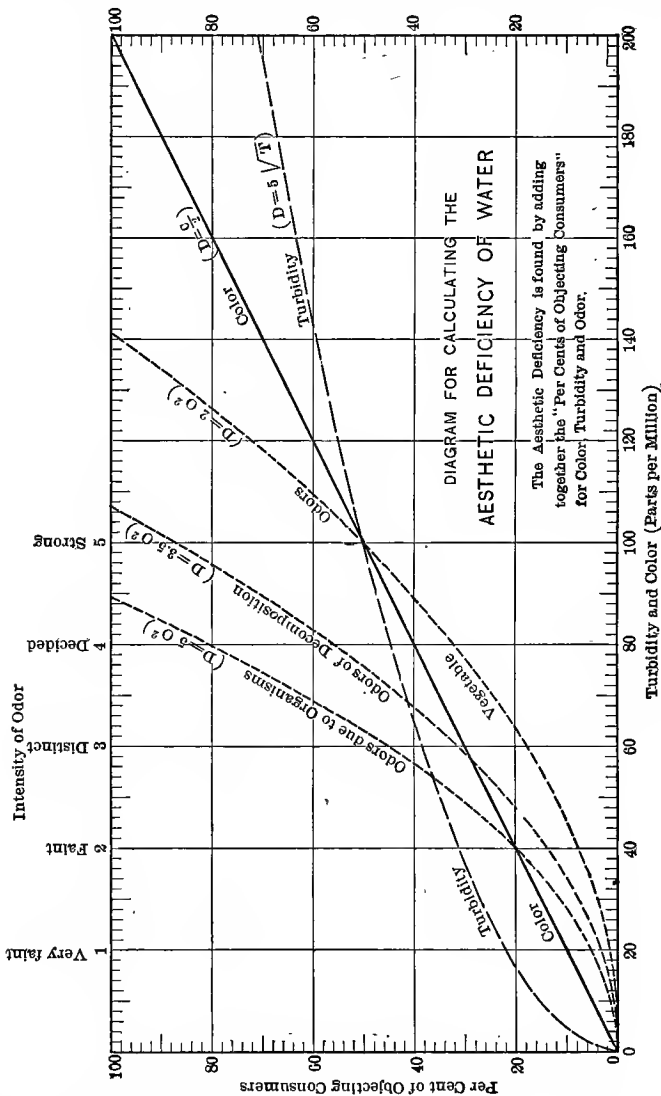

FIG. 59.

nates represent the "per cent of objecting consumers." By this is meant the proportion of the water-takers who would ordinarily choose not to drink the water because of the quality

indicated by the curve, or who would buy spring water, or bottled water, rather than use the public supply, if they could afford to do so. This number would increase, of course, as the general attractiveness of the water decreased. From the curves one may calculate what may be called the *æsthetic deficiency* of the water by adding together the per cents of objecting consumers for color, turbidity, and odor. If the æsthetic deficiency equals 100, it indicates that the water is of such a character that every one would object to it, and figures in excess of 100 only emphasize its objectionable character.

It will be seen from the diagram that when the color of water is less than 20, or the turbidity less than 5, only one person in ten would object to it, but when the turbidity or color is 100, one-half of the people would object to it. It may be thought that this proportion is too low, but it must be remembered that colored waters are invariably accompanied by a vegetable odor and often by a slight turbidity, and that it is the sum of the several quantities which determines the æsthetic rating.

Experience has shown that objection to color varies directly with its amount; consequently this curve has been plotted from the equation,  $p_c = \frac{c}{2}$ , i.e., a straight line, where  $p_c$  stands for the per cent of objecting consumers, and  $c$  for the color.

In the case of turbidity, however, small amounts count for more, relatively, than larger amounts. The equation for the turbidity curve has been taken, therefore, as  $p_t = 5\sqrt{t}$ , where  $t$  stands for the turbidity.

With odor, however, the opposite condition prevails; faint odors count for little, but distinct and decided odors cause much more complaint. Consequently, the per cent of objecting consumers has been made to vary as the square of the intensity of the odor expressed according to the standard numerical scale. The quality of the odor makes quite as much difference as its intensity, and for that reason three curves have been plotted, one representing vegetable or pondy odors ( $O_v$ ), one representing odors due to decomposition ( $O_d$ ), and one representing the aromatic, grassy and fishy odors due to microscopic organisms ( $O_o$ ). These curves are plotted from the following equations:

$$\begin{aligned} p_0 &= 2O_v^2, \\ p_0 &= 3.5O_d^2, \\ p_0 &= 5O_o^2, \end{aligned}$$

in which  $O_o$ ,  $O_d$ , and  $O_v$  stand for the intensity of the three groups of odors mentioned.

These curves represent somewhat imperfectly our present ideas as to the relative effects of color, turbidity, and odor; and on further study they are likely to be considerably modified.

It is a well-known fact that in cities which are supplied with water which is not attractive for drinking purposes, large quantities of spring water and distilled water are sold, and that consumers go to much expense in the purchase of house-filters in order to improve the quality of the water furnished by the city mains. It is fair to assume that in any community the amount of money expended for bottled water and house-filters will vary in a general way, according to the attractiveness of the water, although there is no doubt that the presence of typhoid fever in the community, or the fear that the water is contaminated, will greatly increase the use of auxiliary supplies for drinking. For purposes of calculation it may be assumed that the diagram just described represents this tendency to use vended waters, and that each "objecting consumer" would go to the expense of buying spring water or putting in a house-filter, if he could afford it. It may be argued, also, that the poor consumer who may be unable to do this is as much entitled to satisfactory water as is the well-to-do consumer.

From a study of price-lists of spring waters sold in New York and other cities, it has been found that the ordinary wholesale price of spring water is seldom more than 10 cents a gallon. In some places it is as low as 1 cent. The average is about 5 cents. To filter water through house-filters costs less, but generally it is less satisfactory.

As a convenient figure for calculation, and as a most conservative one for general use, a cost of 1 cent per gallon to the ordinary consumer for an auxiliary supply of drinking water (either spring water or well-filtered water) has been taken. In cities where the cost of procuring and distributing bottled water exceeds 1 cent per gallon, as it does in such a city as New York for example, this should be taken into account in making local use of the data. For the illustrative purposes of the present study, and for general comparisons, the figure mentioned will serve as a satisfactory basis. The average person drinks about 1.5 quarts of liquid per day, of which one-half may be assumed to be water, the rest being tea, coffee, etc. Therefore one-fifth cent per capita daily may be taken as a reasonable figure for the cost of an auxiliary supply. If the entire population used such a supply, and if the daily consumption of the public water-supply were 100 gallons per capita, then one-fifth cent per hundred gallons, or \$20 per million gallons, would represent the loss to the consumers due to an imperfect water-supply which

had an æsthetic deficiency of 100. If the æsthetic deficiency were less than 100, say 37, then the loss to the consumer would be  $\frac{37}{100}$  of \$20, or \$7.40 per million gallons. In other words, the figure for the æsthetic deficiency divided by 5 gives the financial depreciation of the water-supply in dollars per million gallons, or

$$D = 20 \frac{p_a + p_t + p_o}{100}.$$

Example: Suppose the turbidity of a water is 3, its color 65, and its odor 2f (that is, faintly fishy), because of the presence of microscopic organisms; then

$$D = 20 \frac{12 + 32 + 20}{100} = \$12.80;$$

that is, the depreciation of the water, because of its unsatisfactory physical qualities, amounts to \$12.80 per million gallons.

#### DEPRECIATION DUE TO ODOR

Values of  $D$  for different values of  $O_v$ ,  $O_d$ , and  $O_o$  in the formula

$$D = \frac{20(2O_v^2 + 3.5O_d^2 + 5O_o^2)}{100}.$$

Dollars per million gallons.

	Odor.	Vegetable Odor ( $O_v$ ).	Odor of Decomposition. ( $O_d$ ).	Odor Due to Organisms ( $O_o$ ).
0.....	None	0.0	0.0	0.0
1.....	Very faint	0.4	0.7	1.0
2.....	Faint	1.6	2.8	4.0
3.....	Distinct	3.6	6.3	9.0
4.....	Decided	6.4	11.2	16.0
5.....	Strong	10.0	17.5	25.0

**Algæ as Local Nuisances.**—Thus far in this chapter the algæ have been considered from the standpoint of the odor imparted to water used for drinking. The odors are sometimes strong enough to be noticed in the vicinity of the reservoirs, in fact in some cases, the odors have been wafted by the wind for distances of a quarter of a mile. The decay of littoral growths of filamentous algæ sometimes cause objectionable odors along the shore. The odors derived from the exposed bottoms of reservoirs, when the water has been drawn down, are familiar to all, but it is not generally considered that such odors are due largely to algæ. The “odor of the sea” that is so much loved, is similarly due largely to sea-weed.

Algæ are sometimes driven inshore by the wind and stranded on beaches, where they decay and produce foul conditions.

## CHAPTER XIII

### STORAGE OF SURFACE-WATER

*To obtain a permanently safe and satisfactory surface-water supply without filtration the rainfall must be collected quickly from a clean watershed and stored in a clean reservoir.*

A clean watershed may be defined as one upon which there are no sources of pollution and no accumulations of decomposing organic matter. The subject of pollution is of paramount importance, but it will not be emphasized here as its discussion leads into bacteriology rather than into microscopy. No watershed can be wholly free from organic matter, and this must eventually decompose. The grass dies, the leaves fall, and a thin layer of decay is spread over the surface of the ground. This is repeated year by year. Normally this organic matter disappears by rapid oxidation, and if the ground is sloping the rain that falls upon it runs off rapidly and absorbs comparatively little organic matter. If, however, the decaying vegetation has accumulated in thick layers, if the ground is level and becomes saturated or covered with water, decomposition takes place under different conditions, and the water may become highly charged with organic matter and the products of decay.

**Effect of Swamp Land.**—The effect of swamp areas upon the color of water has been referred to. Water from a clean watershed seldom has a color higher than 30 of the Platinum Scale. The amount of color above this figure can be generally traced to swampy land. The color of the stagnant water of swamps is sometimes very high—often 300 and sometimes as high as 500 or 700 on the Platinum Scale. From this it is easy to see that even a comparatively small percentage of swamp-

land upon a watershed may have an important effect upon the color of the combined yield.

A highly colored water means a water rich in organic matter. If the color is much above 50 the water has an unsightly appearance, a distinct vegetable odor, and a sweetish and somewhat astringent taste. But the presence of organic matter is objectionable for another reason. It helps to furnish food-material for the microscopic organisms, and these may render the water very disagreeable. Swamps are breeding-places for many of the organisms that cause trouble in water-supplies, and numerous instances might be cited where organisms have developed in a swamp and have been washed down into a storage reservoir, rendering the water there almost unfit for use.

Cedar Swamp, at the head of the Sudbury River of the Boston water-supply, furnishes an example of this. During August, 1892, *Anabæna* developed abundantly in a small pond in the middle of this swamp. At one time there were 8400 filaments (about 50,000 standard units) per c.c. A heavy rain washed the *Anabæna* down-stream, and on August 15 there were 2064 filaments per c.c. at the upper end of Sudbury Reservoir No. 2, which is long and narrow. On August 17 the water entering the basin contained but 600 filaments, and a week later it contained none. The *Anabæna* were washed down-stream in a sort of wave, which passed through the basin, down the aqueduct, through the Chestnut Hill reservoir, and into the service-pipes. On August 22 *Anabæna* were first observed at the gate-house at the lower end of Reservoir No. 2, where there were 647 filaments per c.c., and on the following day they appeared at the terminal chamber of the conduit at Chestnut Hill reservoir, where there were 326 filaments per c.c. In another week they became disseminated through this reservoir and were found in the service-pipes. As the water from Reservoir No. 2 passed toward the city it became mixed with the water from other sources, so that by the time it reached the consumers the *Anabæna* were not sufficiently abundant to cause complaint. After the first wave of *Anabæna* had passed through Reservoir No. 2 the organisms began to increase

throughout the basin, and the growth continued for several weeks. It was evident that the water from the swamp carried down not only the *Anabæna* themselves, but enough food-material to support their growth in the basin.

Instances are still more common where organisms from swamps have seeded storage-reservoirs. Entering the reservoir in comparatively small numbers, the organisms frequently find in the quiet water conditions favorable to their growth. Growths of some of the *Flagellata* may be traced directly to seeding from swamps. The draining of swamps makes a vast improvement in the quality of the water delivered from a watershed. In general it should be carried out in such a way that the water falling upon the clean portions of the watershed is not obliged to pass through the swamp before entering the reservoir. This may be accomplished by a system of marginal drains or canals. The lowering of the water-table of a swamp also improves the quality of the water delivered from it.

Small mill-ponds and other imperfectly cleaned ponds or pools are also frequent breeding-places of microscopic organisms. Again the Boston water-supply furnishes an example. A short distance above Sudbury reservoir No. 3 there were at one time several mill-ponds. These ponds were favorite habitats of *Synura*. These organisms were often found there in large numbers, and when the water was let down-stream through the mills or when heavy rains caused the ponds to overflow, the *Synura* would become numerous in the reservoir.

**Effect of Pockets.**—Thus it is seen that in order to avoid the growth of troublesome organisms the water should be delivered from a water-shed *quickly*, and should not be allowed to stand in shallow ponds or pools in contact with organic matter. As far as possible a watershed should be self-draining. It may be added that the storage reservoir also should be self-draining. It often happens, when the bottom of a reservoir is uneven, that water is left in small pools as the reservoir is drawn down. These pools are usually shallow and the water becomes warm and stagnant. They often become filled with rich cultures of organisms, and when they overflow the organ-

isms are scattered through the reservoir. Such pools or pockets should be provided with an outlet. If this is impossible it may be advisable to fill them up. The author once observed a pocket in a reservoir that was excavated to a considerable depth for the sake of removing all the organic matter at the bottom. This pocket could not be drained, and during the summer it became the breeding-place of *Synura* and other organisms. It would have been better to have removed a portion of the organic matter and to have covered the remainder with clean material.

It has been stated that water should not be allowed to stand for any length of time in contact with organic matter. It is quite as bad for water to stand over a swamp as it is for it to stand in a swamp. It may be worse, for if the water has sufficient depth the decomposition of the organic matter at the bottom may take place in the absence of oxygen, and under these conditions some of the resulting products are more easily taken up by the water. This brings us to the consideration of the so-called "stagnation effects."

**Effects of Stagnation in Reservoirs.**—By this term is meant a continued state of quiescence of the lower layers of water in a lake or reservoir caused by thermal stratification, as described in Chapter VII. During these periods of quiescence the water below the transition zone, i.e., the stagnant water, undergoes certain changes, the character and amount of these changes varying with the nature of the water and especially with the presence or absence of organic matter at the bottom of the reservoir. Stagnation may be studied best in ponds where there is a considerable deposit of organic matter at the bottom, and of such ponds Lake Cochituate is an excellent example.

Near the efflux gate-house the lake has a depth of 60 ft. At the bottom there is a layer of organic matter of unknown thickness. The upper portion of this is due to deposition of organisms and other organic material transported by the water. The period of summer stagnation extends from April to November, and during this time the deposit of organic matter at the bottom is accumulating.



The changes that take place in the water at the bottom of Lake Cochituate during the summer are shown in the following table, where the analyses of the water at the surface and bottom are compared. The most conspicuous change is that of the color (see Fig. 6o). While the water at the surface is bleaching under the action of the sunlight, that at the bottom grows rapidly darker until, near the close of the stagnation

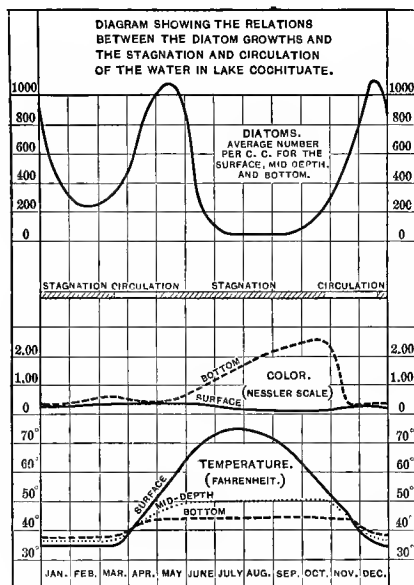

FIG. 6o.—Stagnation Effects. Lake Cochituate.

period, it has a decided opalescent turbidity and a rich brown color. A peculiarity of the water is that its color deepens rapidly after being drawn to the surface. These color phenomena are due to the presence of iron in the water. By sedimentation of iron in combination with organic matter and of ferric hydrate produced by oxidation in the upper layers, a considerable deposit of iron has been formed at the bottom. As the oxygen dissolved in the water at the bottom disappears during the summer, the ferric iron gives up its oxygen to the organic matter

and becomes reduced to the ferrous state. In this state it is soluble. As stagnation continues it becomes dissolved in increasing amounts. When carried to the surface it becomes oxidized to the insoluble ferric state, deepening the color of the water for a time, but later precipitating as a brown sediment and leaving the water with little color. Important changes in the organic matter in the lower layers take place during the stagnation periods. The amount of organic matter in the water increases by sedimentation from above and by solution from the ooze at the bottom. The albuminoid ammonia increases. Decomposition of the organic matter takes place. The dissolved oxygen disappears and the nitrates and iron become reduced. The free ammonia and nitrites increase, and the free carbonic acid increases greatly. After the supply of oxygen has become exhausted, putrefaction through the agency of the anærobic bacteria takes place and the water acquires offensive odors. Increasing amounts of mineral matter are taken up from the bottom by the lower layers of water. This is true not only of iron, but also of silica, manganese, and some of the calcium and magnesium salts. The bacteria below the transition zone increase and forms resembling *B. coli* sometimes multiply.

These stagnation effects are observed only below the transition zone. The relative changes that occur at different depths are well shown by the amount of dissolved oxygen, and the progress of the changes through the season may be studied by a series of such observations. Elaborate studies upon this subject have been made at Jamaica Pond by the Massachusetts State Board of Health for the details of which the reader is referred to the Special Report of 1890 on Examination of Water supplies, and to the Annual Reports for 1891 and 1892. The following tables serve to illustrate these phenomena.

The effect of stagnation upon the microscopic organisms has been referred to. In deep reservoirs relatively little life exists below the transition zone. The ooze at the bottom is largely an accumulation of dead organisms. The few living organisms that are found there are Bacteria, Fungi, Protozoa and Crustacea,

organisms that are parasitic or that play the part of scavengers. The water at the bottom, however, acquires a supply of food-material—both organic and mineral—suitable for microscopic life. After stagnation ceases and the period of circulation begins, this food-material is carried to the upper regions where, with light and oxygen, the plankton are able to utilize it. The diatoms in particular depend upon the food-supply acquired by the water during periods of stagnation.

DISSOLVED OXYGEN AT VARIOUS DEPTHS IN LAKE COCHITUATE, IN PER CENT OF SATURATION.

	Aug. 16, 1891.	Sept. 28, 1891.
Surface.....	79	90
10 ft.....	84	81
20 ".....	36	33
30 ".....	21	9
40 ".....	20	8
45 ".....	2	—
50 ".....	0	0
56 ".....	—	0
57½ ".....	0	—

FREE CARBONIC ACID AT VARIOUS DEPTHS IN LAKE COCHITUATE.

(Parts per million.)

Depth.	May 24, 1901.	Oct. 11, 1901.	Nov. 14, 1901.
Surface	1.5	4.0	6.0
10	2.0	3.0	6.0
20	6.8	10.0	6.0
30	6.0	11.0	6.0
40	10.0	11.0	6.0
50	8.0	19.0	6.0
60	8.0	23.0	6.0 [52 ft.]

The stagnation of a pond that has deposits of organic matter at the bottom affects the quality of the water in two ways. When the bad water at the bottom is carried to the surface during the periods of circulation the entire body of water is affected by it. The color increases, the organic matter increases, and the odor may become unpleasant. These are the direct effects. Odors of the water that are caused by the growth of organisms that have been stimulated by the acquired food-materials are the indirect effects.

**Effect of Organic Matter on Reservoir Bottoms.**—The disagreeable effects of stagnation are not dependent upon the depth of a pond, except in so far as the depth affects thermal stratification. They depend somewhat upon the character of the water stored, but much more upon the amount and character of the organic matter at the bottom and upon the length of the stagnation periods. If the bottom of the reservoir contains no organic matter the phenomena described above will not occur. It has been found that in the Wachusett reservoir of the Boston water-supply, where the organic matter was carefully removed from the bottom, the dissolved oxygen at the bottom does not become exhausted during the stagnation periods, although it is appreciably reduced in amount.

The author once collected a sample from Lake Champlain at a depth of nearly 400 ft. The temperature was  $39.2^{\circ}$ —i.e., maximum density—and the water was probably in a state of permanent stagnation. The sample was bright, clear, colorless, and without odor. The material on the bottom was found to be almost perfectly clean gravel.

Organic matter at the bottom of shallow reservoirs will cause a deterioration of the water stored in them. If there is no summer stagnation the water at the bottom becomes warm, and decomposition goes on rapidly. The products of decay taken up by the water support the growth of organisms—particularly the blue-green algæ. Moreover, during the winter when the surface is frozen these shallow ponds grow stagnant and the conditions become similar to those in deep ponds. After the periods of winter stagnation, shallow ponds often contain heavy growths of diatoms. Organic matter at the bottom of a shallow reservoir affects the quality of the water in another way. It offers support for fixed aquatic plants, and these may injure the quality of a water directly by their decay or indirectly by harboring microscopic organisms.

**Stagnation in Reservoirs at Panama.**—Mr. John R. Downes, Physiologist to the Isthmian Canal Commission, has described the stagnation of the reservoirs of the water supplies at Panama. This occurs even though the reservoirs are relatively shallow

and the temperature of the water high. For example, in the Cocoli reservoir, 9 feet deep, the temperature on one occasion was 83° at the surface and 80° at the bottom, yet the dissolved oxygen varied as follows: Surface, 8.6; 5 feet, 6.2; 7 feet, 0.8; 9 feet, 0.0 parts per million. In Carabali reservoir, 12 feet deep, there was no dissolved oxygen below 8 feet. In Comache reservoir, 26 feet deep, there was none below 14 feet. At certain seasons of the year there are periods of overturn as elsewhere. This stagnation of the bottom water has been the cause of some bad tastes and odors in the water supplies. Algæ occur in these waters but apparently do not cause as much trouble as one might think.

**Sanitary Effect of Algæ Growths.**—While the growth of algæ and other microscopic organisms in surface-waters is often troublesome, yet at times they tend to improve the sanitary quality of the water. The following instances, taken from the records of Mt. Prospect Laboratory, illustrate this:

Baiseley's Pond, one of the sources of water-supply of Brooklyn, is fed by a number of streams which are more or less polluted. During August, 1899, the water of the pond contained a large amount of *Clathrocystis*. Bacteriological examinations of the inflowing streams showed that the water contained from 1000 to 17,000 bacteria per c.c. while the water at the lower end of the pond contained less than 50 per c.c. A study of the analytical records for the same pond during the years 1898-9 showed that the number of bacteria varied inversely with the number of *Clathrocystis*. (See Fig. 61.)

Laboratory experiments made by Strohmeyer and others corroborate the above and show that certain algæ tend to reduce the number of bacteria in water. More recent experiments by Emmerich have indicated that certain Protozoa exercise a similar purifying effect on surface-waters. He has found that two species of the genus *Bodo* will very greatly reduce the number of typhoid-fever germs in water. Staining of the organisms shows that the bacteria are absorbed by the animal-cell, the action being analogous to that of the white-blood corpuscles in the human body upon which Metchnikoff's theory of phago-

cytosis was based. Emmerich considers that these and other Protozoa play an important part in the self-purification of streams.

Experiments by Mr. C. P. Hoover, at the Columbus, Ohio, water filtration plant have shown that the removal of the free

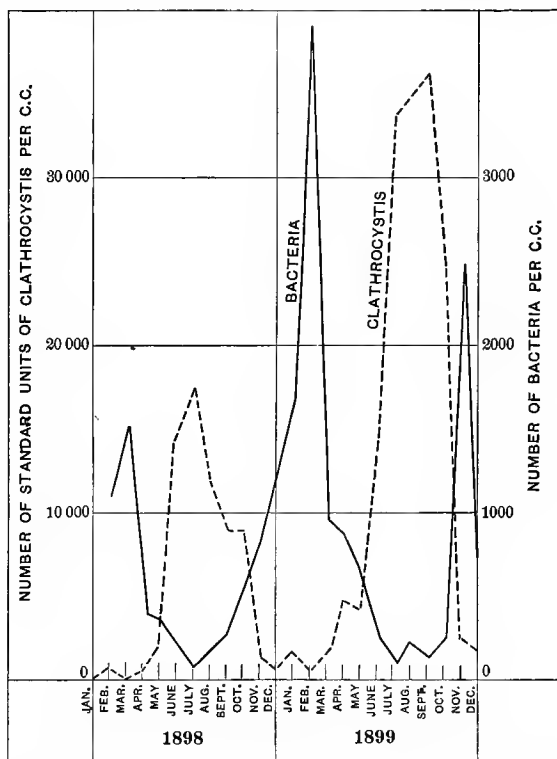

FIG. 61.—Diagram Showing the Number of Standard Units of Clathrocystis and the Number of Bacteria per cubic centimeter in the Water of Baiseley's Pond, Brooklyn Water Supply.

carbonic acid and the half-bound carbonic acid from water will destroy any typhoid bacilli that may be present in the course of a few hours. Inasmuch as the algæ are able to thus render the water alkaline to phenolphthalein, as already mentioned, we have here a possible explanation of the great reduction of bacteria by algæ that sometimes occurs in reservoirs.

**Strohmeyer's Experiments.**—Strohmeyer, at Hamburg, made some interesting laboratory experiments showing how growing Enteromorpha influenced the number of bacteria in the water placed in direct sun-light and in diffused light. Thus in diffused light he obtained the following results:

Date.	Time.	Number of Bacteria per c.c.	
		Enteromorpha Present.	Enteromorpha Absent.
July 4	11.30 A.M.	145	108
4	2.00 P.M.	160	144
4	6.00 P.M.	152	243
5	8.30 A.M.	1100	5900
5	2.00 P.M.	180	26000
5	6.30 P.M.	7	50000
6	9.00 A.M.	24	63000
6	7.30 P.M.	0	80000

## CHAPTER XIV

### SOIL STRIPPING

IN 1907 Messrs. Allen Hazen and George W. Fuller made a study of the advisability of stripping the soil from the sites of the Ashokan and Kensico reservoirs about to be constructed by the Board of Water Supply of the City of New York, Mr. J. Waldo Smith, Chief Engineer. In the course of this study a large amount of valuable information was accumulated, the general results of which were published in the annual report of the Board of Water Supply for 1907. Because of the importance of this report and the very thorough manner in which it was compiled the following quotations are taken from the report *in extenso*. They constitute this entire chapter. The author justifies this long quotation on the ground that he himself had a part in the preparation of the report.

**History of Reservoir Stripping.**—The stripping or removing of soil from the bottom and sides of reservoirs so as to eliminate at the outset practically all organic matter is a Massachusetts custom. For the most part the practice has been confined to that State. In fact, so far as we can ascertain, there is scarcely an impounding reservoir outside of New England which has been thoroughly stripped.

In Europe, impounding reservoirs have not often been stripped; sometimes they have not even been grubbed. We have been able to learn of only three impounding reservoirs there which have been stripped. These are small and have been built on peaty areas. Stripping was undertaken apparently for the reason that at lower points on the same streams older reservoirs were found to have given trouble for a time in earlier years. One of these stripped reservoirs is near Bradford, England.

In India there are quite a number of large impounding

reservoirs, but so far as we can ascertain, none of them has been stripped. The same is true of several projects in Australia of which we have record.

About twenty-five years ago, particularly during the unusually dry seasons of 1881-82, seriously objectionable tastes were experienced in the water from some of the reservoirs supplying Boston. At that time the more recently constructed storage reservoirs of Boston had had the trees and brush growing on the bottom and sides cut down and removed or burned. Shallow flowage had also been eliminated somewhat, but, generally speaking, there was no radical departure in Massachusetts from the practice elsewhere, although there was a well-defined tendency to make flooded areas cleaner.

Beginning about 1883 the cleaning of the bottoms and sides of the reservoirs then under construction was undertaken systematically. Thus Reservoir No. 4 of the Boston water-works, now known as the Ashland reservoir, built in 1882-85, was thoroughly cleaned of all loams, stumps and vegetable matter, and was deepened wherever the original depth below high water was less than 8 ft. The Hopkinton reservoir, built a little later, was similarly prepared, and the same has been true of all large reservoirs since built for the Boston supply. Two of the older reservoirs, namely, Framingham reservoirs Nos. 2 and 3, of the Boston water-works, were also improved about this time by removing all stumps and much of the muck from the sides and bottom as far as they could be exposed by drawing down the water, and by increasing the depths at points of shallow flowage. There were also a few comparatively small reservoirs elsewhere in Massachusetts which were prepared with clean bottoms and sides during this period.

**Early Discussions of Stripping.**—Various reports and records show that twenty years ago and more, distinctly unpleasant conditions in the quality of public water-supplies, especially as regards tastes and odors, were experienced in quite a large number of American cities outside of Massachusetts. Of particular interest is the report made in 1859 to the Croton Aqueduct Board by the late Dr. John Torry. (Transactions American Society of Civil Engineers, Vol. XXI, 1889, p. 555.) A good account of the experiences in early years may be found in the following reports and papers:

1. Prof. Wm. Ripley Nichols, a report upon the cause of algæ growths in water with reference to filtration, in the 1878 Report of the Massachusetts State Board of Health, p. 158.

2. Mr. Alphonse Fteley's report upon the algæ observed in the Boston water-supply in 1879, in the Massachusetts State Board of Health Report, 1879, p. 123.

3. Prof. W. G. Fowler's report upon vegetable growths in drinking water, in the 1879 Report of the Massachusetts State Board of Health.

4. Prof. Wm. Ripley Nichols' paper on tastes and odors of surface waters before the Boston Society of Civil Engineers, Journal of the Association of Engineering Societies, Vol. I, 1882, p. 97.

5. Mr. Geo. W. Rafter's paper before the American Society of Civil Engineers on fresh-water algæ and their relation to the purity of public water-supplies, Transactions of the American Society of Civil Engineers, Vol. XXI, 1889, p. 483.

A number of the writings of the late Messrs. Fteley and Nichols are of much historical significance. Each of these gentlemen had unusual opportunities for making personal studies of important cases. Mr. Fteley was resident engineer for many years of the Boston reservoirs and later became chief engineer to the Croton Aqueduct Commission of New York City. In discussing Mr. Rafter's paper in 1889 (see above reference), Mr. Fteley stated, on p. 518, in connection with the large new Croton reservoir, which was then being planned.

"As to the advisability of removing the loam and all perishable matters from its area before construction it is clearly out of the range of practicability.

"It is certainly better, when within practical limits, to remove the loam from the surface of reservoir grounds near the water mark, although experience shows that inside of a very few years after flowage nature produces that result within the limits of fluctuation, except on flat grounds; but a general removal of the top-soil is not to be advised."

Prof. Wm. Ripley Nichols was a careful observer of these matters, particularly as they related to the reservoirs for the Boston supply. An excellent summary of his various writings and reports is to be found in his book on "Water Supply," published in 1883. His descriptions of the history of organic matter on the bottoms and sides of reservoirs are so clear that several paragraphs, pp. 84-89 of his book are quoted at length.

"A word or two may be in place with reference to the action of fresh water upon vegetable matter in its bearing upon impounding reservoirs. When vegetable matter decays in moist soil, it is converted into a brown or black substance

generally known as 'humus;' this is really a mixture of a number of different bodies, and from it chemists have isolated a variety of substances, such as humic acid and humin, ulmic acid and ulmin.\* The acids of the humus, by oxidation, undergo chemical change, to be sure, being converted into crenic and apocrenic acids which, or rather the salts of which, are found in surface-waters; but when the vegetable matter is thoroughly 'humified,' as in the case of peat, it exerts apparently no bad effect on the water, except by giving it a brown color and a somewhat earthy taste.

"When a recently felled tree is exposed to the action of the water, or when bushes or even grass and weeds are killed by being flooded with water, the sap and more soluble matters are bleached out and putrefy, or, in the presence of much air, undergo other forms of decomposition. This action will take place, no matter under what depth of water the vegetable matter may be placed, but the effect will be less marked as the amount and motion of the water is greater.

"After the more soluble portions are extracted, the subsequent decay proceeds with extreme slowness, provided the remaining cellulose or woody fiber is kept continually covered with water, but alternate exposure to the air and water soon causes decay, as every one knows. In a natural or artificial reservoir the inevitable variations of level are very disadvantageous. As the level is lowered those aquatic plants which grow in shallow water die, and if the water rises after only a short interval it becomes impregnated with the products of their decay; if a considerable interval elapses, land plants grow upon the exposed surface, and being drowned by the rising waters, tend to its contamination in the same manner.

"It appears from this, that in the construction of impounding reservoirs, the mass of growing plants, as well as the soil in which they have their roots, and which of itself contains more or less soluble organic matter, should be removed as thoroughly as possible, especially if the water is to be of no great depth above it when the reservoir is flooded. If the reservoir is filled without such removal of the organic accumulations, a long time may be required before the chemical changes have combined themselves and the water becomes well suited for use, *but the complete removal of the soil, as far as such removal*

\* For a résumé of the investigations on the composition of humus, see Julien, Proceedings American Association, XXVIII, 1879, p. 313 and following.

*is practicable, is not a guaranty that no trouble will arise from a newly filled reservoir.* Occasionally the vegetable decay in a new reservoir gives rise to much offense from the formation of sulphureted hydrogen. A marked instance of this occurred in one of the basins of the Sudbury River supply, Boston, Mass., the summer after it was first filled. The whole mass of water in the basin was permeated with the odor, which was so strong on the leeward side of the pond as to incommode the passers-by. The odor was not that of pure sulphureted hydrogen as prepared in the laboratory, and the gas was no doubt accompanied by other chemical products. The water drawn from the depths of the pond had the odor of an antiquated privy. The presence of sulphureted hydrogen was made very manifest by suspending in the gate-house cloths wet with a solution of acetate of lead; these became yellowish-red, and finally jet black, owing to the formation of sulphide of lead.

“The formation of the sulphureted hydrogen is readily explained. The flooding of the basin started the decay of a large quantity of organic matter; this taking place in the presence of the sulphates contained in the water changed them into sulphides, and from these sulphides thus formed sulphureted hydrogen is liberated by the acid products of decay. This same change takes place to a less degree in almost all ponds and reservoirs. The gas is formed, however, mainly at the bottom, and as it diffuses upward and mixes with the overlying water it comes into contact with the oxygen in the water and is decomposed. The sulphur is set free and sinks to the bottom, or in a very finely divided state flows off with the water. . . .

“These algæ, when present in any considerable quantity, give a repulsive appearance to the water, and when they are in a state of decay they communicate to it an offensive taste and odor. Fortunately, in most cases, the trouble which they cause is of short duration, although often recurring in the same water-supply year after year. Their presence is not a sign of contamination, as they occur in natural ponds removed from all polluting influences. *While, however, they do grow in pure waters and in old and clean ponds, they seem to grow more abundantly in water containing mud and vegetable extractive matter, as in newly filled reservoirs; so that, while immunity from their presence cannot be guaranteed in the case of any pond, they may with some certainty be looked for in dirty and especially shallow ponds. A warm temperature and shallow water are perhaps of even more importance than the products of decay of higher*

*plants, for all surface-waters contain the ammoniacal and mineral salts necessary for the growth of the algæ.*

*“As far as our present knowledge extends, there is nothing that can be done to exterminate the algæ from ponds in which they occur. . . .”*

**Discussion of Stripping by Dr. Drown.**—Between 1890 and 1895 Mr. Frederick P. Stearns, and Dr. T. M. Drown, the Chief Engineer and Chemist, respectively, of the Massachusetts State Board of Health, carried on important researches on soil stripping, based on extensive analyses and surveys of local water-supplies. Their studies were summarized by Dr. Drown as follows:

1. Waters containing organic matter in the presence of oxygen are decomposed by bacterial action and in this oxidation the carbon and the hydrogen of the organic matter take precedence over the nitrogen. Objectionable tastes and odors seldom result from this decomposition of organic matter in the presence of oxygen. The measure of this change in organic matter was taken as being indicated by the free ammonia.

2. Where oxygen becomes exhausted the organic matter in water is subjected to the activity of other kinds of bacteria. Such waters are spoken of as “stagnant” and the bacterial process which stagnant waters undergo is spoken of as “putrefaction.” Resulting from the putrefaction of organic matters, stagnant waters possess offensive odors, due largely to sulphureted, carbureted and phosphoreted hydrogen.

3. The stagnation of water is stated not to be objectionable in itself, and a practical suggestion of much merit is made with regard to the correction of the offensive odors from stagnation by means of aeration.

4. The several reports made it plain by inference that the objectionable tastes and odors of stagnant waters are due to gases of decomposition and not to growths of organisms. In fact, recent evidence makes it appear that the fungi are only organisms capable of growing prolifically in stagnant water and they do not directly cause objectionable tastes and odors.

5. Stagnant waters are improved by aeration partly by the mechanical removal of objectionable gases and partly by the oxidation of dissolved compounds, especially salts of iron.

6. The opinion was restated that the character of the bottom of reservoirs affects stagnation and putrefaction of the water therein contained more than does the dissolved and suspended organic matter in the water itself.

7. Cases were noted where reservoirs contained stagnant

and offensive bottom layers in which the amount of organic matter was less than in the top water when the latter contained both oxygen and organic growths producing seriously disagreeable odors.

8. It was recognized that one of the beneficial effects of aeration in stopping excessive growths of algæ was contributed by the agitation of the water.

As a result of these investigations and of others made under the direction of Desmond FitzGerald Superintendent of the Boston Water Works, the following conclusions were reached in 1895 in regard to the stripping of the Wachusett reservoir.

“As a preliminary conclusion, based on the facts determined in this investigation, it may be said that the effect of the organic matter in these various soils on the water in contact with them is simply a question of its amount, and that its origin and composition seem to be without marked influence. The watershed from which the samples were taken is very sparsely populated, and the organic matter in all cases is mainly of vegetable origin.”

“It is probable, therefore, that we need only concern ourselves with the amount of organic matter in a soil of this character in determining the necessity of its removal, and as a provisional standard we may perhaps fix 1.5 to 2 per cent of organic matter, as determined by the loss on ignition of the sample dried at 100° C., as the permissible limit of organic matter that may be allowed to remain on the bottom and sides of a reservoir.”

**Results of Stripping in Massachusetts.**—In the 1904 Report of the Massachusetts State Board of Health, p. 144, is given a record of the results of extended observations made by the Board upon surface-waters throughout the State. In this table the waters are divided into five groups, the first group being of waters having the least odor, and the fifth group of waters containing the most offensive and objectionable odors.

There are 64 reservoirs in this list. Many of these are very small, and for that reason are not comparable with large reservoirs. For the purpose of this discussion we have excluded all reservoirs less than 100 acres in area. This leaves only 17 reservoirs, 11 of which were more or less completely stripped. These 11 are practically the only reservoirs of considerable size in the United States which have been stripped.

The essential facts as to stripping have been supplied by Mr. X. H. Goodnough, Chief Engineer of the Board. These

data for the large reservoirs of the State are classified according to stripping as follows:

STRIPPED RESERVOIRS IN MASSACHUSETTS OVER 100 ACRES IN AREA.

Place.	Reservoir.	Year Put in Service.	Area in Acres.	Capacity M.G.	Average Depth, Feet.	Supply Held (Days)	Odor Group.
Worcester	Lower Holden.	.....	149.3	742	15.2	161	I
"	Kent.....	.....	119	513	13.2	142	II
"	Upper Holden.	.....	185	794	16.8	174	II
"	Leicester.....	.....	143	681	14.6	235	II
Met. Water District	Sudbury.....	1897	1292	7253	18	332	II
"	Wachusett....	1905	4200	63100	46	534	III
"	Framingham 2	1878	134	530	12	12	III
"	Framingham 3	1878	253	1183	15	43	III
"	Ashland.....	1885	167	1464	26	227	III
"	Hopkinton....	1894	185	1521	26	261	III
Cambridge	Lower Hobbs.	.....	467	1450	10	220	III

Average odor group.....2.5

UNSTRIPPED RESERVOIRS IN MASSACHUSETTS OVER 100 ACRES IN AREA.

Holyoke	Wright & Ashley.....	.....	280	1510	16	500	III
Holyoke	Whiting.....	.....	115	500	13	300	IV
New Bedford	Old Storage....	.....	300	400	4	550	IV
Lynn	Walden.....	.....	128	403	12	308	V
Springfield	Ludlow.....	.....	387	1344	11	75	V
Whitman.	Hobart's Pond	.....	175	.....	.....	.....	V

Average odor group.....4.3

DESCRIPTION OF ODOR GROUPS

*Group I.* Waters which are odorless or which have occasional faint odors.

*Group II.* Waters which are usually odorless but have occasionally a distinct and at times an unpleasant odor.

*Group III.* Waters which have frequently a noticeable and at times a distinct or unpleasant odor.

*Group IV* Waters which have generally a noticeable odor which is frequently unpleasant or disagreeable.

*Group V.* Waters which have generally a strong and frequently an unpleasant or disagreeable odor.

These results indicate a substantial reduction in odor in the stripped reservoirs and the reduction is no doubt largely due to stripping.

The chief fact, however, to be learned from the practical application of reservoir stripping in Massachusetts is that it does not entirely or uniformly eliminate unpleasant or offensive odors from impounded surface-waters. This is shown by occasional tastes and odors even in the Ashland, Hopkinton and Wachusett reservoirs as they continue in service. It certainly reduces these odors to a considerable extent when compared with the results obtained under more or less comparable conditions from unstripped reservoirs. But the evidence is clear that stripping alone cannot be relied upon to produce an impounded water satisfactory as to tastes and odors at all times.

**Effect of Stagnation Upon the Quality of Water.**—There are four ways by which the quality of water is unfavorably affected by stagnation in the bottom layers of deep reservoirs which become stratified, namely:

1. The amount of free carbonic acid in the water increases during the time when the oxygen is being exhausted through the action of bacteria upon the organic matter. This increase in free carbonic acid, facilitates the solvent action of the water upon lead pipes and in Great Britain seems to have had considerable practical significance with reference to lead poisoning.

2. Odors of decay due to putrefaction of organic matters are found in the water as drawn from the bottom layers. These odors are largely due to compounds containing more or less sulphur and phosphorus. They result from the putrefaction of the organic matter originally present in the bottom and sides of the reservoir and in the water flowing into the reservoir, and also from that resulting from the organisms which either grow in the bottom layers or which reach there by settling down from the upper portions of the reservoir.

3. The appearance of the water is made quite unsightly due to the marked increase in the amount of organic matter dissolved by the water and to the iron which is extracted from the soil and which in a ferrous condition unites with the organic matter. The color and appearance of such stagnant waters

is very high and unsatisfactory, particularly after partial aeration by exposure to the air.

4. In the bottom layers many kinds of organisms are found; but so far as we can ascertain it is chiefly the fungi which grow in large numbers in the stagnant layers. Algæ and diatoms when present in the bottom layers appear to arrive there only by settling down from above.

In this country the increase in color in stagnant bottom waters is noticed in practically every instance, and this is true to a greater or less extent of the odors of decay.

Comparatively little has been heard in this country of the increased power of impounded water to dissolve lead or objectionable fungus growths in bottom layers, but in Great Britain, as has already been stated, lead poisoning has been more or less of a practical matter. Indeed, in order to neutralize free carbonic acid in the water of the new Elan Valley reservoirs of the Birmingham supply, it was found desirable to add lime at times. This has also been done at Burnley and elsewhere.

Heavy growths of *Cladotrix* and other fungi have been noted in several large reservoirs, particularly those of the Elan Valley works (Birmingham) and the Vyrnwy works (Liverpool) in Wales. Neither of these reservoirs was stripped and Lake Vyrnwy was not even grubbed. Although in each case water is drawn from the top, these growths have caused deposits in tunnels and pipes leading from the reservoirs to the filters and materially reduced their carrying capacity. So far as known these fungi do not directly cause bad odors or tastes either by growth or disintegration.

**Irregularity of the Occurrence of Objectionable Growths.**— We have been impressed with the evidence showing that while some reservoirs are regularly subject to troublesome growths, there are others which are troubled only at intervals. With increasing knowledge upon this subject it appears that numerous ponds and reservoirs, which were formerly supposed to have such clean bottoms and sides that no serious growths could result, are actually subject to such growths at intervals; and that it is more difficult than was believed in 1890 to prevent such growths.

Current views need to be more or less changed upon the following points:

- a.* Irregularities of seeding reservoirs with organisms.
- b.* Growths temporary and frequently not noticed or recorded.

*c.* Available food for organic growths other than nitrogenous matter from reservoir bottom and sides.

*d.* Effect of winds and other means of securing agitation and aeration and thus preventing growths.

We will review briefly the present evidence upon the above points.

**Seeding.**—Troubles arise from growths of organisms in reservoir waters only when the water is seeded or infected with the organisms. This is a difficult element to take fully into account, as there are cases where reservoirs have been used for years with satisfactory results, after which, without warning, objectionable growths of organisms have started. It is obviously possible and easy to confuse the absence of seeding and the absence of conditions favoring growths in seeking the true reason for freedom from objectionable growths in ponds, lakes and reservoirs.

There is not a great deal of definite information available as to how reservoirs become seeded. Sometimes the spores of organisms are brought into a reservoir by the water coming from the watershed. In other cases the spores seem to be transferred by the wind from swampy places in the general neighborhood. There seems to be no way of keeping the germs or seeds of organisms out of a reservoir; and, although the absence of seeding appears to have been an important element in some phenomena which have been observed and which are otherwise difficult of explanation, it must be assumed that in every case a reservoir may sooner or later become seeded with objectionable vegetable or animal growth.

Among the best illustrations as to the freedom from growths of organisms through absence of seeding are those to be found in numerous ponds and lakes in the South, some of which are used as sources of water-supply and where all other conditions seem to favor abundant growths of organisms.

It may be that there is some antagonism exerted by some groups of organisms which prevents the growth of other groups. We simply mention this point as a possibility. We have obtained no evidence which enables us to discuss it even in general terms.

Other illustrations of the irregularity of organic growths in surface-waters are to be found in many of the large natural ponds and lakes throughout the North and including coves and arms of some very large lakes.

The development of water filtration in this country has also furnished illustrations as to the irregularity of organic growths

in uncovered filtered water reservoirs. We have examined all available experiences in this regard and find that the results are conspicuous by the absence of growths under conditions where we would certainly expect them if the water was seeded. The list of such filtered water reservoirs, where the clear filtered water more or less resembles ground water, included experiences obtained both with sand filters and mechanical filters. Among such reservoirs we may mention the distributing reservoirs at Paterson, N. J., and Watertown, N. Y.

**Growths Temporary and Frequently not Noticed or Recorded.**—Recent information tends strongly to show that growths which would be objectionable in a public water-supply are far more frequent in natural ponds and lakes than was formerly supposed. Such growths frequently are of short duration and casual examinations do not reveal their existence. For this reason less importance is to be attached to the supposed favorable conditions in lakes having clean and sandy bottoms than was formerly believed to be the case. In fact, we know of several cases where very deep natural lakes with clean bottoms such as Lake Champlain, have developed vegetable growths in the upper layers of water.

It is also a fact that objectionable growths are frequently of an intense character for a short time and then disappear quite suddenly and leave the water in a satisfactory condition. This, of course, has much significance where the water requires a considerable period for its passage from a storage reservoir through a distributing reservoir to the consumer. It is believed that growths in some quite clean storage reservoirs have in this way escaped detection by the water consumers.

Another factor bearing upon our knowledge as to growths of organisms in reservoirs is that the results of analyses made at intervals sometimes fail entirely to show the presence of objectionable conditions. Even where the analyses are made at intervals of about one month, as in Massachusetts, it has been found in a number of instances that the reports from the laboratory do not correctly portray the conditions existing at the reservoir. Actual experience at Springfield and Holyoke, Mass., and elsewhere has still further shown that the agitation and aeration of samples of water during transportation to the laboratory frequently minimize the apparent amount, intensity and effect of growths of organisms.

Taking all of these elements together it is certain that more growths of organisms and more objectionable results therefrom at the source have resulted in reservoirs and natural lakes with

comparatively clean sides and bottoms than was formerly supposed to be the case.

**Nitrogenous Food.**—The food for growths of organisms does not necessarily come from organic matter stored on the bottom of flooded areas within the flow line. Much of the organic matter may reach a storage reservoir by entering with flowing water.

Instances are numerous where large bodies of water stored in reservoirs of entirely artificial construction have been troubled with growths of organisms. The Central Park reservoirs in New York City, and the Ridgewood reservoirs of Brooklyn, are notable illustrations. Another case where organic growths obtained their food-supply outside of the reservoir is that of the Waban Hill reservoir in Newton, Mass., now used by the Metropolitan Water Board.

**Weeds as Source of Food.**—It is found that the organic matter which most influences the composition of the impounded water is that of the grass, shrubs and weeds which are submerged. Should a reservoir after having been stripped have its sides exposed so that the weeds may grow, it is difficult and expensive to prevent more or less organic matter reaching the water from this source. Experience shows that this factor relates principally to the case of large reservoirs which from time to time during dry seasons are drawn down and in the case of reservoirs which require a considerable period for their initial filling after the completion of the original stripping.

**Growths of Organisms as Sources of Food.**—It has already been stated that the albuminoid ammonia contents in some Massachusetts waters sometimes reach in summer about three times the normal. This increase is due to the organisms themselves which may grow in quite large quantities in the top water of deep reservoirs and which may be entirely independent of the character of the original bottom of the reservoir. Such growths sooner or later subside in large part to the bottom of the reservoir and tend to accumulate upon it. The decomposition of the matter so deposited furnishes the material for subsequent growths.

It is quite apparent that stripping affords no assurance that ample food will not be available in the upper water for organic growths sooner or later. This is all the more apparent when it is realized that during periods of vertical circulation following periods of stagnation there is such a mixing of the water that the top layers may be supplied with necessary food coming from the decomposition of organisms deposited on the bottom.

**Sewage Pollution as Source of Food.**—In the early Massachusetts data it was stated, that where there was a population of 300 or more per square mile of drainage area, the organic matter and other substances, such as nitrates, etc., resulting from this population had a pronounced influence upon the organic growths. In recent large projects for impounded water-supplies the catchment areas have usually been so sparsely populated that sewage pollution appears to be a very small factor. Indeed it is believed that it may be practically ignored in such cases. The population upon the Esopus watershed is very small.

**Temperature of Surface-water.**—Objectionable growths of Protozoa and diatoms are sometimes found in reservoir waters during the winter when the water is covered with ice. Diatoms and some forms of algæ appear in objectionable quantities during the spring and fall periods of overturning. It is during warm weather, however, when the temperature of the water is near or above 70 degrees that the greatest and most objectionable growths of blue-green algæ are encountered, and it is these growths which have given the greatest amount of trouble in this country. The temperature of the water is apparently of controlling importance with reference to growths of anabæna and some other blue-green algæ.

The fact that in Great Britain the summer temperature of reservoir waters seldom exceed 65 degrees and only exceeds 60 degrees for short periods, is probably the explanation of why the upper layers of water in the large English reservoirs have been so singularly free from objectionable growths of blue-green algæ. Accordingly the British experiences are not to be used as safe precedents as to midsummer complications from growths in American reservoirs. We understand that this fact was appreciated by the Massachusetts authorities in 1890.

**Wind and Agitation.**—Increasing information has shown that a vigorous development of certain filamentous algæ is reached only in a fairly quiet state of water. As pointed out by Dr. Drown, this is one reason why they do not occur in river waters. The waves produced by the winds in comparatively large reservoirs and lakes are often sufficient to prevent such growths. At Ludlow reservoir, in Springfield, vigorous growths of anabæna have sometimes appeared, and a single windy day has sufficed to eliminate them. This wind action breaks up the growths, causing them to subside, and it may be weeks before they appear again. Toward the end of the season they may not start again after having been once broken. Small

lakes are less disturbed by wind. This is one of the reasons why small lakes, other things being equal, are much more subject to growths than larger lakes or reservoirs. This also explains in part why organic growths often develop in coves protected from wind action, and particularly where water weeds prevent agitation of the water.

The wind not only affects the organisms mechanically, but influences their growth by controlling the amount of carbonic acid in the water. A gentle breeze, just sufficient to stir the water of a shallow reservoir to the bottom, but without causing high waves, may increase the amount of carbonic acid in the upper layers by carrying it upward from the bottom; while a heavy wind in the same reservoir might reduce the carbonic acid in the upper layers by making the loss to the atmosphere greater than the increase from the bottom.

Reference may also be made to the growth of organisms in a distributing reservoir supplied with water from a large lake where the organisms do not grow, as has been frequently observed. It seems to be accounted for by the relative protection of the water from the action of the wind in the smaller area of this distributing reservoir. A striking example of this is furnished by Syracuse, where objectionable growths have occurred in the distributing reservoir supplied with water from Skaneateles lake. Other examples are the reservoirs of Burlington, Vt., and Cleveland, Ohio, which are supplied with water from Lake Champlain and Lake Erie, respectively.

In this connection it is interesting to cite the explanation of Prof. Shaler as to why some of the large lakes and ponds have continued to the present day without becoming entirely filled up with peat and muck resulting from vegetation in the water, as in the case of most of the lakes left by the glacial period in New England which have become filled. He states that the controlling factor is the existence of wave action which prevents the growth of organisms which would otherwise fill up the lake.

**Conclusion as to Advantages of Stripping the Reservoirs.**— We conclude from the available evidence that the effect of stripping the bottoms and sides of reservoirs upon the quality of the reservoir water as regards stagnation, is as follows:

1. The stripping of the sides and bottom of a reservoir will ordinarily prevent stagnation of the bottom layers for a period of years the length of which depends upon various local conditions. In the Boston reservoirs this period does not seem to exceed from 10 to 20 years.

2. Ultimately it makes comparatively little difference as

to stagnation of the bottom layers whether the sides and bottom of a reservoir are stripped or not.

3. By aeration and filtration of the bottom water of deep reservoirs there can be obtained a better quality of water without the benefit of stripping, than it is possible to obtain with the aid of stripping in the absence of aeration and filtration.

4. In the absence of stripping substantially as good a quality of bottom water may be obtained after aeration and filtration, as in the presence of stripping. In fact, as just stated, decolorization and purification are facilitated by the absence of stripping due to bacterial agencies which make some of the iron in the soil available as a coagulant.

5. In view of the above and as aeration and filtration will ultimately be required in order to obtain satisfactory results in this climate, present evidence and experience indicate that beyond grubbing a reservoir it is unwise to spend money for further removing organic matter from the bottom and the sides.

We may add that we are aware that materials obtained in stripping may be used successfully in building dikes, as at the Wachusett reservoir, and that by so doing the net cost of stripping may be reduced. We also take into account the fact that any deep deposits of muck when sufficiently firm to carry it may be covered with sand at less expense than would be required for their complete removal. We will not enter into a discussion in this report of different methods of reservoir construction, but will simply state that in the preceding paragraph we have had in mind the net cost of stripping.

**Comparative Cost of Stripping.**—The cost of stripping the Ashokan reservoir would be very great, possibly as much as five million dollars. Aeration of the water as it leaves the reservoir will do as much, if not more to remove the tastes and odors than stripping would do to prevent them, and the cost of aeration would be only a small fraction of the cost of stripping.

For the cost of thoroughly stripping the Ashokan reservoir it would be possible to build a filter plant to filter all the water that could be obtained from the Esopus watershed; and a filter plant between the Kensico reservoir and New York City, following aeration, would be far more efficient in preventing tastes and odors and in otherwise improving the quality of the water, as supplied to the consumers, than stripping could be, even under the most favorable conditions.

We are firmly of the opinion that materially better results, due to the stripping of the Ashokan reservoir, could not be

obtained by such aeration and filtration, as regards either the quality of the purified water or the cost of purification.

Further, if for financial reasons it is necessary to defer the construction of filters until after the first water is delivered to the City from the Ashokan reservoir, it still will be unwise to strip the reservoir. It is better to save any money that might be so spent for use in providing filters when that becomes possible.

**Recommendations as to the Treatment of the Ashokan Reservoir.**—Our conclusions, after careful deliberation upon this matter, in the light of experience now available from various large city water-works, lead us to the following recommendations:

1. *Clearing and Grubbing.*—Cut all trees and bushes close to the ground over the entire area of the sides and bottom.

2. *Burning Vegetation.*—Burn all grass, weeds and shrubs and see that this is done shortly before the areas are flooded. In other words, do not allow the water to flood any areas on which expansive growths of weeds have occurred since the original preparation of the area.

3. *Preparing the Shores.*—Around the shore of the reservoir, to a vertical depth of at least 20 ft. below high water, remove all stumps, and, so far as necessary, roots and other matters which might become exposed by continued wave-action; and leave the surface with even slopes, so that the shores will be maintained in a presentable condition when the water is drawn down. We do not think it is necessary to spend a large amount of money in this preparation. The wave-action will tend to clean it and accomplish the desired results, but some extra attention should be given to it with reference to its appearance when exposed, and also to prevent as far as possible the leaving of enclosed shallow areas which might serve as places where the spores of organisms would remain and serve as centers of infection when conditions in the reservoir became favorable.

4. *Preparing the Bottom.*—After removing all the top vegetation from the swamp areas, which can be done by cutting it off close to the surface and burning, careful examination should be made for places where the surface "crust" is so loosely attached to underlying soft material that it might rise after the reservoir is full. We have given this question some attention when examining the swamps, and their surfaces wherever we have seen them are such that this factor does not appear to be of much importance here. However, experience elsewhere indicates that it should be given further attention.

5. *Each Basin to Have Outlet.*—The separation of the reservoir into two parts, with outlets so that water may be drawn from either or both basins into the aqueduct, seems advantageous to us.

6. *Draw at Any Level.*—We recommend that the reservoir outlets be arranged so as to permit water to be drawn from any desired depth.

7. *Aeration.*—Arrangements should be provided to aerate thoroughly all the water passing from the reservoir to the aqueduct, except perhaps at times of extremely low stages of water in the reservoir. This can be accomplished by fountains and basins, or other effective appliances to make available the head of the water in leaving the reservoir for bringing it in contact with air to remove the gases, which produce tastes and odors and which result from putrefaction in the stagnant layer and odors from the growth of organisms in the water; and also the carbonic acid which otherwise might serve as a food for further growths in the Kensico reservoir.

In making the foregoing recommendations we desire to state clearly, that we consider:

First, that the stripping of the Ashokan reservoir in itself will not sufficiently prevent tastes and odors so as to allow water of satisfactory quality to be obtained from it at all times.

Second, that aeration at a small fraction of the cost will do fully as much in removing tastes and odors as stripping would do in preventing them.

Third, that water of perfectly satisfactory quality can be obtained by aeration and filtration.

Fourth, that this result can be just as certainly and fully accomplished in this way if the Ashokan reservoir is not stripped as if it is stripped.

It is certainly more important to consider the questions of the quality of the water leaving the Kensico reservoir than that of the water leaving the Ashokan reservoir. In accordance with your instructions, we shall report upon the treatment of the Kensico reservoir in a subsequent communication after further local data are available.

**Effect of Aeration and Filtration upon the Quality of the Kensico Water and the Relation of the Same of Stripping.**—This matter was carefully considered by Messrs. Hazen and Fuller in connection with the report on the stripping of the Ashokan and Kensico reservoirs of the New York City water-supply. The following extended quotation from their report bear upon the subject:

We have considered the question whether, with aerators and filters installed, the tastes and odors resulting from growths in the reservoir would be entirely removed at all times, and whether it would not be worth while to strip this reservoir for the sake of securing a better water after filtration.

We have considered this question in the light of all available evidence as to the effect of aeration and filtration in the removal of tastes and odors. We are most decidedly of the opinion that after aeration and filtration the water will be uniformly of satisfactory quality whether the reservoir is stripped or not, and that stripping the reservoir will make no appreciable difference in the quality of the filtered water.

**Aeration.**—The effect of aeration alone in reducing taste and odors in a number of well established examples was set forth in our report on the stripping of the Ashokan reservoir. Among these we mentioned the removal of odors from the water from the Newark, N. J. reservoirs; from the Grassy Sprain reservoir at Yonkers, N. Y.; from the Whiting Street reservoir at Holyoke, Mass.; and from the Ludlow reservoir at Springfield, Mass. These cases are all well attested. We believe there can be no doubt as to the results that are practically obtained by aeration. These cases have great weight with us, because we have known about them personally, and have observed the great reduction in tastes and odors which has been brought about by a simple and inexpensive method of adequate exposure to air.

Aerating as we have it in mind is not comparable with that resulting from exposing the water to air in the aqueduct. We take aeration to mean the exposure of water in fine drops, practically spray, for an interval of say 2 seconds or more corresponding to a nozzle discharge under at least 16 feet head. The 16-foot head and the 2-second interval are not given in any way as limits. Actually, more head will be used when available, and with the reservoir drawn down smaller amounts of head and exposure will be used which, though less effective, will still be serviceable. Such aeration for the head and interval mentioned will not only oxygenate water, but it will, as indicated by the data at our disposal, reduce free carbonic acid from about 20 to about 5 parts per million and remove considerably more than half or probably three-quarters of the odors of growth and of decomposition.

**Filtration.**—The reduction of tastes and odors by filtration to a greater or less extent, and often to the extent of entire removal has been a matter of common observation. We have

personally noted such reductions in many cases. We have also known some cases where filtration, as actually carried out, has failed to sufficiently remove tastes and odors, but we have known of no case where tastes and odors could not be sufficiently removed by filtration and adequate aeration.

Where waters have contained abnormally large amounts of organic matter, much more thorough methods of treatment are required than in other cases. The application of methods, sufficient for the treatment of water that is only moderately bad, have failed when applied to the treatment of the worst waters. We have kept clearly in mind all such comparative failures that we have known about, and we fully believe that they do not afford the slightest ground for assuming that well selected methods at moderate cost will not be fully adequate in this case.

Among the cases where filtration has served to entirely remove tastes and odors we may mention the English experiences, where waters from many impounding reservoirs are supplied after filtration without any complaint from tastes and odors. We may also mention the case of Reading, Pa., where filters were constructed for the specific purpose of removing tastes and odors from the water of an impounding reservoir. These filters operate at a rate of 5,000,000 gallons per acre daily while one of the filters is out of service for cleaning, which, in summer time, is a considerable percentage of the time; otherwise at a somewhat lower rate. These filters were installed as the result of successful experiments upon the removal of tastes and odors from these reservoir waters, and have been in service for a sufficient length of time to fully test them. Mr. Emil L. Nuebling, Superintendent of Water Works, writes as follows:

“Our Antietam filters operate at a rate of 5,000,000 gallons per acre daily only when one bed is out of commission on account of scraping and refilling, but they have at all times successfully removed the tastes and odors which were formerly so obnoxious that the water, at times, could not be used during the periods of *Anabæna* growths. Some of the success in removing the odors may be attributed to the aeration of the raw water before it passes through the filters.”

At Brisbane, Australia, with experimental filters, water from the Enoggera reservoir, having very bad tastes and odors, has been purified so that the effluents from certain devices, corresponding in a general way to those proposed for the New York water-supply, though with much worse water and with a lower rate of filtration, have uniformly produced effluents

entirely free from tastes and odors. This was tested by one of us to his personal satisfaction at the time of his recent visit to Australia by most carefully tasting and smelling of the various waters upon the ground; and we have the assurance of the chemist and other competent persons as to the conditions at other times.

As stated above, there are some limits to the removal of tastes and odors by filtration. These limits are investigated at length at Springfield, Mass., and the investigations were conducted partly by the Massachusetts State Board of Health. The quality of the water of the Ludlow reservoir at times went beyond the point where simple filtration at such rates as are proposed for the Ashokan water was capable of removing the tastes and odors, but it only went beyond the limit at a certain season of the year. The State Board of Health in their report of April 3, 1902, states as follows in regard to the filtration of the Ludlow reservoir water:

“This filter was operated, except for a short time, as a continuous filter at a rate of 2,500,000 gallons per acre per day, and in the latter part of the year at a considerably higher rate, and was successful in removing the objectionable odors from the reservoir water except at the time of the presence of the excessive quantities of organic matter in August and September when the effluent of the filter had for a time the odor characteristic of the water of the reservoir and in nearly as pronounced a degree. The results obtained by filtering the water through other similar filters at a rate nearly twice as great as that employed during the year with a large filter were nearly equal to those obtained with that filter. None of these filters, however, to which the Ludlow water was directly applied removed the characteristic odor from the reservoir water during the time in August and September when this water contained excessive quantities of organic matter.”

Filtration at this high rate, practically as high as proposed by us for the Catskill supply, thus sufficed to fully remove the tastes and odors from Ludlow water for ten months of the year or more.

The Ludlow reservoir is perhaps the most notoriously bad smelling reservoir in the United States. Some other reservoir waters are no doubt worse, but they are less well known than the Ludlow reservoir and have not been studied so carefully. It is certain that the water of the Ashokan and the Kensico reservoirs will never reach a condition even approximating the worst conditions at Ludlow. It is reasonably

certain that these reservoirs will never become charged with organisms, and with the tastes and odors resulting from their growth, to a greater extent than was reached by the water of Ludlow reservoir during those ten months of the year when simple filtration at a high rate sufficed to completely remove tastes and odors. The Springfield experiments made by the Massachusetts State Board of Health, therefore, give assurance of the success of the method of filtration proposed as applied to the waters of the Ashokan and Kensico reservoirs.

Still additional data from Springfield, Mass., are available in reports of Mr. E. E. Lochridge, now Engineer of the Water Department of that city. For some ten weeks in 1903 he conducted an elaborate series of tests, under the direction of Messrs. Gray and Fuller, with results as set forth in a special report to the City Council of Springfield, March 28, 1904. These tests were made during the "Anabæna period," when the water is in its worst condition and included experiments not only with the Ludlow reservoir water, but also with the much worse water of the Belcherton reservoir which was abandoned as a source of water-supply years ago.

The water from the reservoirs was put through a strainer or roughing filter and also aerated before it was put through various sand filters at rates ranging from 3,000,000 to 10,000,000 gallons per acre daily. Taking into consideration the quality of these reservoir waters as applied to the sand filters, as shown by daily analyses, in comparison with the quality of the water of the Catskill supply, and bearing in mind that the Catskill water can be readily aerated much more thoroughly than was actually done in the Springfield tests, there is no room for doubt that the filtration of the water from the Ashokan and Kensico reservoirs at rates averaging 5,000,000 gallons per acre daily will be entirely satisfactory.

We do not refer to the actual successful experience with the intermittent filtration of the Ludlow water, because intermittent filtration is adapted to treat very bad water and probably is no better than continuous filtration for treating waters that are not exceptionally bad. It could be used at Kensico, should the conditions require it; but there is no indication that it will be required, or that any better results could be secured with it.

The removal of tastes and odors from the water of Goose Creek reservoir at Charleston, South Carolina, may also be mentioned as an extreme case. Goose Creek reservoir was made by flooding 1,800 acres of uncleared marsh covered

with much vegetation to an average depth of 3.5 ft. The water in it is exposed to a sub-tropical sun, and has growths of organisms greater than could ever be anticipated in the latitude of New York. It has been treated with substantially satisfactory results. It is true that the process is more elaborate and extended than is proposed for New York. Allowing for the difference in conditions it is clear that no such methods as are actually used at Charleston would ever be required for treating the New York waters. We cite the Charleston case, from among a number of successful experiences in treating bad-smelling waters, simply to show that tastes and odors can be sufficiently removed even when present to an extent many times greater than can be reasonably anticipated in the waters under consideration.

We are perfectly satisfied as a result of the evidence herein mentioned, and of our general experience with filters, and of observing their operation and of noting the odors before and after filtration, that the proposed filtration works will serve to fully remove tastes and odors from the proposed Kensico reservoir water, and that, practically speaking, this result will be reached with equal certainty whether the reservoir is stripped or only cleared and grubbed as herein recommended.

**Effect of Stripping on the Cost of Filtration.**—It is possible that the stripping of the Kensico reservoir would reduce the growths of organisms in such a way as to reduce the cost of filtration. It might be possible to operate the filters, taking water from a stripped reservoir, at a higher rate, thus reducing the size and first cost of the plant; and it might also be that they could be operated for longer periods between cleanings, thereby reducing the cost of operation. These matters we have considered at length.

Generally speaking, the conditions which limit the rate of filtration and size of a filter plant are the winter conditions. Any filter plant sufficient to meet the winter conditions will be able to perform satisfactorily during any summer conditions likely to exist in the proposed Catskill supply, or in any ordinary reservoir supply. There is no evidence that the stripping of the Kensico reservoir would make any material difference with the condition of the water in the winter. If the winter conditions should be the limiting ones at Kensico, then the stripping of the reservoir would make no difference with the allowable rate of filtration. It may be, however, that the removal of tastes and odors in summer would be the limiting condition of the rate that could be used. There is no indication, from

the records of the present Kensico reservoir water nor from any other data elsewhere which we have at hand, that this would be so for a plant provided with adequate aeration. Practically, we do not believe that this would be the limiting condition. Conceding, however, for the moment for purposes of discussion, that summer growths might control, we can at least make an approximate calculation of the additional cost that would be involved.

In a previous communication we proposed the use of an average rate of 5,000,000 gallons per acre daily as a proper one for the purification of this water. This is based on the use of water from an unstripped reservoir.

For the purpose of calculation assume that with a stripped reservoir a rate of 6,000,000 gallons per day could be used instead of the 5,000,000 rate above assumed. It should be distinctly understood that we have no reason for believing that such a relative increase in rate would be possible, and we do not believe, that the difference in conditions would justify such an allowance; but we make the computation to show the amount of money that could possibly be saved in case such an assumed increase in rate were made possible by stripping.

Conceding for the moment that such a difference might be made, for an average yield of 250,000,000 gallons per day from the Ashokan watershed, it would make the difference between 50.00 acres and 41.67 acres of filter surface. The difference in area would thus be 8 1-3 acres, costing perhaps \$600,000, without including the piping and general appliances that would be the same whatever the rate. This is certainly the largest possible estimate which can be placed upon the difference in cost of filter plant attributable to stripping.

Stripping would make no difference in the settling basins which were suggested and have been considered in some of the filter projects. Such settling basins are clearly unnecessary in connection with the treatment of any and all waters to be derived from the Ashokan watershed. Such basins were contemplated only for use in connection with the waters from other watersheds yielding highly colored waters to be ultimately diverted to the Ashokan system; and in the light of the present evidence it seems unlikely that such treatment would be required even with these matters after they had passed the Ashokan reservoir. Certainly the stripping of the Ashokan and Kensico reservoirs would have no tendency to remove the color from such waters.

We have also considered the probability of obtaining longer

periods between the cleanings of filters with the cleaner water from a stripped reservoir, and the consequent reduction in the cost of operation.

In considering this point the operation of covered filters and open filters must be sharply distinguished. Most of the filters with which the experiences in removing tastes and odors have been obtained have been open filters. For the filtration of this water we are considering the use of covered filters. Open filters are often choked and clogged more rapidly by organisms which grow in the water upon them than by organisms which may already be in the incoming water. For this reason the evidence as to the frequency of cleaning of open filters does not have much bearing on the frequency of cleaning to be reasonably expected in the operation of covered filters.

Considerable experience has been had with the rate of clogging of filters by other substances than vegetable growths on the filters, and this allows some idea to be formed of the probable effect of a greater or smaller number of organisms upon the cost of operation. Taking it up on the basis of such general experience, the rapidity of clogging would not be proportional to the number of organisms. Doubling the number of organisms would not reduce the period by more than one-fourth. Further, the expense of operating a filter plant is not directly proportional to the amount of cleaning and of washing and of handling sand. Taking it altogether, a wide difference in the number of organisms would be necessary to produce a considerable effect upon the cost of operation of filters.

For eight months in the year there is no reason to suppose that stripping would affect the frequency of cleaning or the cost of filtration in any way. For four months in the year, more or less, it is possible that some difference in the length of the runs would be made. A very liberal estimate is that the cost of operation for this period might be reduced one-third by stripping. This would represent a reduction of one-ninth in the cost of operation of the filters for the whole year, attributable to stripping.

The cost of operating filters with the Ashokan water, and with modern appliances for cleaning filters and handling sand, would certainly not exceed 75 cents per million gallons. It is likely that it would be much less than this figure. One-ninth of 75 is 8 1-3 cents per million gallons as the extreme amount of saving which could be made in the cost of operation by stripping. For 250,000,000 gallons per day, the amount

of water which can be obtained from the Ashokan watershed, this saving would amount to \$20.83 per day, or \$7,600 per year, equal to 5 per cent on a \$152,000 investment; and this represents the largest possible amount, as we see it, which could be saved in the cost of operation by stripping the Ashokan and Kensico reservoirs. With less than the full amount of water used the saving would be proportionately less. The total saving possibly made in the case of filtering on these lines would, therefore, be:

Saving in cost of plant. . . . .	\$600,000
Capitalized cost of operation. . . . .	152,000
	<hr/>
Total amount to be saved. . . . .	\$752,000

We repeat what we said at the outset: We have no reason to believe, and do not believe, that any such saving could be made. The calculation is given to show the maximum possible saving which could be made under assumed conditions. The saving even if made in the first years would not be permanent. It would gradually decrease to nothing as the deposit which forms on the bottom of reservoirs in this climate gradually covers the present surface and eliminates its effect upon the water. The significance of such deposits in several of the present reservoirs of New York City has already been recorded in this report.

As against this possible saving, which we believe is much larger than could actually be reached, the cost of stripping the Kensico reservoir is roughly estimated at \$1,100,000, and the cost of stripping the Ashokan reservoir is estimated at \$5,000,000, making the total cost of stripping \$6,100,000.

There is no possible way in which the cost of stripping, or any considerable portion of it, could be saved through a resulting reduction in the cost of construction and operation of filters.

**Questions Connected with the General Operation of the Plant.**—We do not deem it necessary at this time to enter into a discussion as to whether it would be best to draw the water from the top or from the bottom of the Kensico reservoir, or for what portions of the time it would be best to draw from the top or the bottom or from any intermediate point. When the plant is put in service it will be operated under trained and intelligent supervision. The results actually to be obtained by the use of water from different points will be soon ascertained, and water can and should be drawn at all times from

that part of the reservoir which yields the best results. In our previous report upon the stripping of the Ashokan reservoir we have attempted to give some description of the principal changes and growths taking place in the different parts of such a reservoir, and of their practical effects upon the quality of the water, and of the ways in which water from the different parts can be most advantageously handled; but we regard it as a useless speculation to attempt to determine in detail at this time how the plant can best be operated in practice, in view of all the varying conditions from season to season.

In the same way, we have in mind that in practical operation water will be drawn to the filters directly from Kensico, or through the aqueduct and by-pass from Ashokan, according as the best results can be obtained. The usefulness of the Kensico reservoir as a reserve against accidents and repairs to the aqueduct, will not be in the least reduced by the direct use on the filters of Ashokan water whenever better results can be obtained in that way.

We have also considered the possibility or probability that disagreeable odors in troublesome quantities will be evolved by the aerators. In considering this question we have kept in mind that the water quantities will be large; that strong growths of objectionable organisms are sometimes to be anticipated, and that water which has been through vigorous putrefaction would necessarily be drawn at times. This would happen at the times of the spring and fall turn-overs, even though bottom water were never drawn. We have considered that there might be times, when, because of these odors, it would be inexpedient to use the Kensico water drawn through an aerator at the outlet of that reservoir, and that at such times it would be desirable to use water coming directly from the Ashokan reservoir. We have considered that probably for a large part of the year it would make but little difference in the practical results whether the aerators at Ashokan and at Kensico were used or not. There will be times, however, when the use of the aerators will be absolutely essential to secure the desired quality of water. The aerators at both reservoirs must be provided for these occasional periods. When they are provided, with the proposed arrangements, it will cost practically nothing to operate them. Aerating the water at other seasons of the year than when necessary will tend in a general way to improve its quality. The tendency may be slight for a large part of the time, but it will be in the right direction. The aerating plants that we have suggested will

also be more or less pleasing features of the landscape, and objects of interest to the public.

We, therefore, consider that the aerators will no doubt be often used, even when they have but little effect upon the quality of the water.

**Conclusions as to Stripping.**—After full consideration of the question of stripping the proposed Kensico reservoir we are firmly convinced that stripping without filtration will not produce at all times water of satisfactory quality.

If, however, for financial reasons it is necessary to defer the construction of filters it is still unwise to strip the reservoir. It is better to save any money that might be so spent for use in providing filters when that becomes possible. We are equally convinced that stripping will not materially affect the efficiency or the cost of filtration.

Filtration and aeration, without the stripping of either the Ashokan or Kensico reservoirs, will enable an entirely satisfactory quality of water to be delivered to The City, and this is the treatment which we advise.

We recommend that the sides and bottom of the Kensico reservoir be well cleared, as recommended for the Ashokan reservoir, and that they be not stripped.

We recommend that the shores of the Kensico reservoir be treated with special care to a vertical depth of 35 feet, in the way that was suggested for the treatment of the shores of the Ashokan reservoir, to a depth of 20 ft. This additional depth is with reference to the possible depth that the reservoir will be drawn, and to its location near to New York City, and in a populous district, where it will be under observation, and where the maintenance of the shores in a sightly condition, at all times is highly desirable.

## CHAPTER XV

### STORAGE OF GROUND-WATER

*Ground-water must be stored in the dark in order to prevent the growth of microscopic organisms.*

Water that has passed through the soil usually carries mineral matter in solution, some of which forms an important ingredient of plant-food. It also usually contains free carbonic acid. When such water is stored in an open reservoir it is liable to deteriorate. Diatoms especially are liable to develop, because their mineral contents are greater than those of most plants, much silica being required. These growths are less likely to occur in a new reservoir than in one that has been long in use. The seeding of the reservoir must first take place. As a rule some of the littoral organisms develop first, growing on the sides or even on the bottom of the reservoir. Gradually a deposit of organic matter collects at the bottom, and the conditions become favorable for the growth of the limnetic organisms.

Of the diatoms that occur in ground-water exposed to the light *Asterionella* is by far the most troublesome. Others may make the water turbid, but the *Asterionella* is very odoriferous. In surface-waters it has been found that this organism develops most vigorously after the stagnation periods. It is probable that this is true also in ground-waters. Most reservoirs for the storage of ground-water are shallow and of comparatively small size. Often water is not pumped directly through them. Such reservoirs become stagnant at times, and it has been observed that in them the *Asterionella* show a spring and fall seasonal distribution like that observed in surface-

waters. It sometimes happens that for many years an open reservoir gives no trouble, but that finally a layer of organic matter accumulates at the bottom, the water in some way becomes seeded with *Asterionella*, and thereafter regular growths of these organisms occur. If open reservoirs are to be used for the storage of ground-water they should be kept clean.

**Mixed Surface and Ground-water.**—When a water-supply is taken partly from the surface and partly from the ground it is even more necessary that covered storage reservoirs should be used. This is because the surface-water may contain organisms the growth of which in the reservoir would be stimulated by the food-material in the ground-water, and because organic matter will be deposited from the surface-water, increasing the effects of stagnation and making it possible for *Asterionella* growths to occur. The water-supply of Brooklyn, N. Y., presents an interesting example.

The supply of this city is derived from a number of small storage reservoirs along the southern shore of Long Island and from driven-well stations and infiltration galleries along the line of the aqueduct. The well-water is drawn from depths varying between 25 and 200 ft. The waters become mixed in the aqueduct and are stored in three basins comprising Ridgewood reservoir. The different sources of water vary greatly in character. Some contain an abundance of organic matter; some have high free ammonia, nitrites, and nitrates; some have considerable iron; and one or two have high chlorine and hardness due to admixture of a small amount of sea-water. All have carbonic acid. The watershed is sandy, and the waters are rich in silica.

***Asterionella* in Ridgewood Water.**—In 1896 *Asterionella* developed in Ridgewood reservoir in great abundance, and since then it has reappeared at intervals. In a general way these growths have shown the spring and fall distribution, but they also correspond to some extent with increased proportions of ground-water used. At times the numbers of *Asterionella* present have been very high—25,000 or 30,000 per c.c.

For many years Ridgewood reservoir caused no trouble and the water-supply bore an enviable reputation. It was not until a considerable deposit of diatoms and other organic matter had accumulated on the bottom of the basins and until the amount of ground-water had come to be about 40 per cent of the total supply that the conditions became favorable for such enormous growths of *Asterionella*. Fortunately for the consumers, a by-pass around the distributing-reservoir permits the water to be pumped from the aqueduct directly into the distribution system. This was used whenever the *Asterionella* in the reservoir become abundant enough to cause a bad odor. During recent years copper sulphate has been used.

**Storage of Filtered Water.**—Water that has been filtered resembles ground-water, and microscopic organisms may develop in it to such an extent as to cause trouble. For this reason provision is generally made for storing filtered water in covered reservoirs. Often, however, from motives of economy, it is necessary to use existing reservoirs which are not covered. Such reservoirs at times become affected with microscopic organisms, but these seldom cause as much trouble in filtered water as in ground-water exposed under similar conditions. Water which has been filtered by the mechanical system of filtration is somewhat more liable to growths than the same water filtered by sand filtration. This is because the use of sulphate of alumina leaves a certain amount of dissolved free carbonic acid in the water, which tends to favor the growth of the organisms. On the other hand the effluent of a sand filter may contain a larger amount of nitrogen in the form of nitrate, a condition in which it is more available for use by the algæ. The controlling factor, however, is usually the length of storage in the reservoir. If the period is short the growths are usually insignificant, but if the water is kept in the reservoir for many days algæ are likely to develop to a troublesome extent.

As an illustration of the effect of storage on a filtered water the following figures taken from analyses of the Hudson River water at Poughkeepsie, New York, before and after filtration are interesting:

Date, 1903.	Microscopic Organisms per c.c.	
	Raw Water.	Filtered Water after Storage.
April 23.....	60	1455
May 11.....	70	135
June 8.....	95	65
June 20.....	65	130
July 8.....	205	655
July 23.....	230	2440
August 6.....	185	2265

**Growth of Organisms in the Dark.**—Darkness is not always sufficient to prevent a ground-water from deteriorating. There are some organisms that can live without light, and indeed prefer darkness. Of such a nature are the fungi (using the word in its broad sense as including those vegetable forms destitute of chlorophyll) and some of the Protozoa and larger animal organisms.

**Crenothrix in Ground-water.**—Crenothrix is the most important organism of this character that affects ground-water supplies. It is a small filamentous plant, the cells of which are but little larger than the bacteria. Its filaments have a gelatinous sheath colored brown by a deposit of ferric oxide. It grows in tufts, sometimes matted together into a felt-like layer. Other organisms similar to Crenothrix are Clonothrix, Gallionella and Chlamydothrix.

Crenothrix is liable to occur in ground-water rich in iron and organic matter. It frequently infests water obtained from wells driven in swampy land. It is often observed in imperfectly filtered water. It may grow in almost any part of the system—in the driven wells, filter-galleries, reservoirs, and distribution-pipes. It is especially liable to occur about wood-work.

Crenothrix causes trouble in tubular wells by choking them with deposits of iron. It causes trouble in the service-pipes by reducing the capacity of the pipe. But it causes most trouble when the filaments break off and become scattered through

the water. It is then liable to make the water unfit for laundry use on account of deposits of iron-rust.

Crenothrix has caused annoyance in many water-supplies. The "water calamity" in Berlin first drew attention to its evil effects. In 1878 the water from the Tegel supply became filled with small, yellowish-brown, flocculent masses which settled to the bottom when the water was allowed to stand in a jar. The odor of the water and the effects of the iron oxide in washing were decidedly troublesome. Crenothrix was not found in Lake Tegel, but was found in many wells, in the reservoirs at Charlottenburg and in the unfiltered water of the river Spree.

In 1887 the water-supply of Rotterdam was badly affected with Crenothrix. The water was drawn from the river Maas, and, after sedimentation, was filtered. At the time when Crenothrix appeared the system was being enlarged. New filter-beds were in use, but the filtered water was conducted through the old conduits and the old reservoir to the old pumps. In the old conduit, or flume, there were many wooden timbers, and on these Crenothrix was found growing in abundance. Inspection showed that some of the water was imperfectly filtered, and that this impure water was the chief cause of the sudden and extensive development of Crenothrix.

It has been recently found that Crenothrix thrives best in water which contains little or no oxygen but where carbonic oxygen is present in considerable amounts.

For a more complete description of the organisms in this group the reader is referred to "Die Eisenbakterien," by Dr. Hans Molisch.

**Floating Roofs.**—Various attempts have been made to prevent the access of light to reservoirs by constructing cheap roofs or floating rafts of boards. It is said that in some cases these have effectually prevented the growth of algæ. They do not appear to have been permanently successful and their economy is questionable, except for very small reservoirs. If used at all the entrance of sunlight through the cracks between the boards should be prevented.

## CHAPTER XVI

### COPPER TREATMENT FOR ALGÆ

IN 1904 Dr. George T. Moore and Karl F. Kellerman, of the Bureau of Plant Industry, U. S. Department of Agriculture published a report stating the results of successful experiments made by them in the eradication of algæ and other microscopic organisms from reservoirs by the use of copper sulphate. This report immediately attracted wide attention and the method was tried in many places. Nearly ten years' experience has shown its advantageous use in many situations and has likewise developed some of its shortcomings.

Copper sulphate had been used as a fungicide long before Moore proved its worth for destroying algæ. Many experiments had been made by Miquel, Devaux, and many others, which showed that very minute doses of poisonous substances were able to destroy the unicellular microscopic organisms, but Moore deserves full credit for the use of copper sulphate in water-supplies. The first practical test on a working scale was made by him at the water-cress beds in Ben, Va., in 1901, where a troublesome growth of *Spirogyra* was eliminated.

**Effect of Copper on the Human System.**—The first question that was naturally raised when the copper treatment was mentioned was its possible effect on the human system. Moore had collected extensive data to show the extent to which copper salts were used in medicine and the wide distribution of copper in nature, its presence in vegetables and even in natural waters themselves. Clark showed that some natural waters in Massachusetts contained small amounts of copper. Experience with the use of copper in many water-supplies has fully demon-

strated the innocuous character of this treatment if properly carried out. It is not a matter, however, that should be left to the ordinary laborer. It needs intelligent and continual supervision.

**Method of Applying Copper Sulphate.** The method of application is extremely simple. Ordinary commercial crystals of blue-vitriol are used. The required quantity of these crystals is placed in a coarse bag, gunny-sack, perforated bucket, or wire basket, attached to a rope and drawn back and forth in the water at the stern of a rowboat. Or an out-rigger may be arranged so as to drag two or more bags at the same time, thus cutting a wider swath. By rowing slowly along about 100 lbs. can be thus dissolved in an hour. By using several boats quite a large reservoir can be covered in a working day. For a very large reservoir a motor launch may be used. In making the trips the parallel paths of the boats should be about 20 ft. apart. Care must be taken not to row too slowly, as too great a concentration may be obtained near the bags, and if fish should swim into this overdosed water they might be poisoned.

It is generally preferable to carry out the treatment on a day when the wind is blowing, so that the circulation of the water may more readily distribute the chemical. Advantage may be taken also of vertical convection currents. If the algæ to be killed are near the surface the application should be made early in the day when the surface-water is warming and tending to become stratified; but if the algæ are well scattered through the water it is better to make the application toward night. It will often be found best to row against the wind. A knowledge of the currents such as may be obtained from Chapter VII, will be an aid to judgment in this matter. It has been found difficult to treat a frozen reservoir with copper sulphate, as the chemical does not diffuse readily, but precipitates at the bottom near the point of application. The solution of copper sulphate is heavier than water.

**Nature of the Reaction.**—Just how the copper sulphate acts in the destruction of algæ it is difficult to say, involving as it does intricate problems of cytological chemistry. That

copper exerts a toxic effect is, however, well known. Much interest is attached to the fate of the copper that is not involved in the reaction with the organisms, for manifestly not all of copper sulphate is so utilized. Does it remain in solution or is it deposited at the bottom of the reservoir, where it cannot possibly harm those who drink the water? Generally speaking the latter condition prevails.

The sulphate of copper reacts with calcium bicarbonate, which is present to a greater or less extent in nearly all natural waters, to form sulphate of calcium and basic copper carbonate, some carbonic acid being liberated. The basic copper carbonate may then become decomposed, copper hydrate and carbonic acid being formed. Copper hydrate is almost insoluble in water. Basic copper carbonate is somewhat soluble in water which contains carbonic acid, especially if the hardness of the water is low. Experiments have shown that in hard waters the reactions above mentioned take place in the course of a few hours, the copper hydrate first becoming a colloid and then precipitating as solid matter in suspension. In softer waters the reaction takes place more slowly. It seems probable, however, that the reduction of the carbonic acid brought about by the organisms themselves may hasten the reaction. The presence of organic matter in solution tends to retard it. The reaction is more rapid in warm than in cold water. The precipitation of the copper hydrate is hastened by the presence of suspended matter. This is probably a physical action. These are all important matters, for the quantity of copper sulphate required to remove the algæ is closely related to the speed of the reaction.

The precipitated copper settles to the bottom and later may be recovered from the mud. Goodnough found that the mud in the reservoir at Arlington, Mass., contained as high as 0.3 per cent of copper. This precipitated copper, in the mud after it has ceased to be in a colloidal condition, does not appear to be objectionable.

**Quantity of Copper Sulphate Required.**—It is of great importance that just the right quantity of copper sulphate be

used. If too little is applied the algæ will not be destroyed; if too much is used, there is danger that fish may be killed and there is also the money waste.

In deciding upon the quantity to be used several factors need to be considered, such as the kind of algæ present, the amount of organic matter in the water, the hardness, the presence or absence of carbonic acid, the temperature, the kind of fish present, and of course the quantity of water to be treated. Some of these matters were considered in the preceding section.

It is hazardous for one not familiar with the various matters involved to attempt to treat a water-supply with copper, as the effect of overdosing may produce disastrous results in the destruction of fish and other animal organisms. Of particular necessity is it to know what organisms are present that need to be killed. For this a microscopical examination is essential. Fortunately this is an easy matter for a water-works superintendant to determine. A simple equipment like that described in Chapter III and a general knowledge of the different organisms such as may be obtained from the plates at the end of this book should be sufficient to furnish the desired information.

**Quantity Required to Eradicate Different Organisms.**—Organisms differ considerably in their susceptibility to copper sulphate. Some of the blue-green algæ are destroyed by the application of only one part of copper sulphate in ten million parts of water, while other organisms require more than ten times as much as this, and some twenty times as much. One of the organisms most easily killed is *Uroglena* which can be eradicated by using as little as one part of copper sulphate in twenty million parts of water.

It is probable that the stage of growth of the organisms is also a determining factor and that the presence or absence of carbonic acid is important. Different observers have brought in different figures for the quantities that have proved efficacious with the same organisms. It is impossible to state any very definite figures for the quantities required, but the following figures chiefly given by Kellerman, one of the originators of the method, are believed to be as reliable as any.

## QUANTITY OF COPPER SULPHATE REQUIRED FOR DIFFERENT ORGANISMS.

Organisms.	Parts per Million.	Pounds per Million Gallons of Water.
<i>Diatomaceæ</i>		
Asterionella.....	0.10	0.8
Fragilaria.....	0.25	2.1
Melosira.....	0.30	2.5
Synedra.....	1.00	8.3
Navicula.....	0.07	0.6
<i>Chlorophyceæ</i>		
Cladophora.....	1.00	8.3
Conferva.....	1.00	8.3
Hydrodictyon.....	0.10	0.8
Scenedesmus.....	0.30	2.5
Spirogyra.....	0.20	1.7
Ulothrix.....	0.20	1.7
Volvox.....	0.25	2.1
Zygnema.....	0.70	5.8
Microspora.....	0.40	3.3
Draparnaldia.....	0.30	2.5
Raphidium.....	0.30	2.5
Coelastrum.....	0.30	2.5
<i>Cyanophyceæ</i>		
Anabæna.....	0.10	0.8
Clathrocystis.....	0.10	0.8
Coelosphærium.....	0.30	2.5
Oscillaria.....	0.20	1.7
Microcystis.....	0.20	1.7
Aphanizomenon.....	0.15	1.2
<i>Protozoa:</i>		
Euglena.....	0.50	4.2
Uroglena.....	0.05	0.4
Peridinium.....	2.00	16.6
Glenodinium.....	0.50	4.2
Chlamydomonas.....	0.50	4.2
Cryptomonas.....	0.50	4.2
Mallomonas.....	0.50	4.2
Dinobryon.....	0.30	2.5
Synura.....	0.10	0.8
<i>Schizomycetes:</i>		
Beggiatoa.....	5.00	41.5
Cladothrix.....	0.20	1.7
Crenothrix.....	0.30	2.5
Leptomitius.....	0.40	3.3

The figures given may be assumed to apply at a temperature of  $15^{\circ}$  C. or  $59^{\circ}$  F. Moore and Kellerman state that these should be increased or decreased by about 2.5 per cent for each centigrade degree below or above  $15^{\circ}$  C.

They also state, though with less assurance, that an increase of 2 per cent should be made for each ten parts of organic matter per million and an increase of 0.5 to 5 per cent for each ten parts per million of alkalinity. A 5 per cent increase should be made if the amount of carbonic acid is small.

**Calculating the Volume of Water to be Treated.**—Usually the quantity of water to be treated is not known exactly; but has to be estimated. The following data will assist in making this estimate.

The problem is first to find the number of million gallons of water in the reservoir. When this has been found, the total quantity of copper sulphate required is ascertained by multiplying this by the figure in the last column of the preceding table corresponding to the organism that is to be killed. This must then be increased or decreased slightly to take account of the other factors above mentioned.

One million gallons of water represents a depth of about 3 ft. over one acre. Hence the number of acres of water surface, multiplied by the average depth of the water divided by 3 gives approximately the number of million gallons of water in the reservoir. In an ordinary reservoir the average depth may be taken as about one-third of the maximum depth.

If the reservoir to be treated is so deep that the lower strata are stagnant the calculation should be made to include only the water above and within the transition zone. This involves a knowledge of the temperatures at different depths which may be obtained by the method described on page 86.

**Safe Limit for Treating Water to Prevent Killing Fish.**—Kellerman recommends that in order to prevent killing certain fish the following limits should be set to the amount of copper sulphate applied to water.

It will be seen that some of the amounts required for algæ destruction are critically near the amounts that will

kill fish. This explains] the need of cautious application of this remedy.

Fish.	Parts per Million.	Pounds per Million Gallons (Approximate).
Trout.....	0.14	1.2
Carp.....	0.30	2.5
Suckers.....	0.30	2.5
Catfish.....	0.40	3.5
Pickarel.....	0.40	3.5
Goldfish.....	0.50	4.0
Perch.....	0.75	6.0
Sunfish.....	1.20	10.0
Black bass...	2.10	17.0

**Secondary Growths of Organisms.**—It not infrequently happens that after copper sulphate has been used to destroy a certain kind of algæ, this growth is followed by a second growth of some other organism. Thus, following the destruction of *Anabæna* a growth of diatoms may occur. Usually the second growth is an organism less susceptible to the influence of copper than the first, but sometimes the same species returns.

This raises the question as to whether organisms do not become accustomed to the chemical to such an extent that larger doses are required for subsequent treatment. While some observations appear to indicate that this may be so, there is no reason to believe that it goes very far, or that it is a matter to be seriously reckoned with.

In dosing a reservoir it must not be forgotten that organisms sometimes become concentrated within the transition zone, and that these organisms may be carried up into the circulating waters by a high wind and cooler weather. Hence, watch should be kept of such growths, so that a subsequent treatment may be given if these organisms show signs of increase.

**Increase of Bacteria after Copper Treatment.**—A secondary effect of the copper treatment is to increase the number of bacteria in the water. This has been observed so often that it may be considered as a universal phenomenon. The fol-

lowing figures by Jackson illustrate this bacterial increase. They refer to one of the reservoirs of the water-supply of Brooklyn that had been treated with copper to destroy a growth of *Asterionella*.

EFFECT OF COPPER SULPHATE ON WATER BACTERIA AFTER A REDUCTION OF *ASTERIONELLA*.

Date.		Number per Cubic Centimeter.	
		Microscopic Organisms.	Bacteria.
March 13, 1905	Before treatment	4625	405
14	After "	3645	600
15	" "	3325	6,000
16	" "	1925	11,000
17	" "	1850	12,000
18	" "	1575	45,000
20	" "	1350	100,000
21	" "	900	440,000
22	" "	350	630,000
23	" "	350	310,000
24	" "	400	107,000
25	" "	360	80,000
26	" "	300	64,000
27	" "	270	50,000
28	" "	150	37,000
29	" "	100	20,000
30	" "	100	8,000
31	" "	60	3,500
April 1	" "	28	860

Sometimes the numbers of bacteria are even higher than those given in the table.

The bacterial growth may be alleviated by dosing the water with hypochlorite after the dosage with copper.

**Subsequent Odors of Decomposition.**—The decay of the algæ after they have been killed sometimes causes a temporary increase in the odor of the water. This is usually of short duration and sometimes it does not occur at all.

**Copper Sulphate as a Disinfectant.**—Copper sulphate will destroy bacteria if a sufficient quantity is used. The amount required is considerably greater than that needed to destroy algæ. For killing bacteria copper sulphate is less efficient than hypochlorites or liquid chlorine.

**The St. Thomas Experience.**—An interesting after-effect of the use of copper sulphate occurred at St. Thomas Ontario. There the destruction of the algæ in the reservoir deprived of its food-supply the pipe moss which had been growing luxuriantly in some of the main pipes. Consequently these pipe-dwelling organisms died and decayed, causing foul odors in the water as it left the service taps.

**Treatment of Water Prior to Filtration.**—One of the situations where the use of copper sulphate has proved of much use is when the water in an algæ-laden reservoir is applied to a filter. Such growths tend to clog both sand and mechanical filters, reducing the yield of the filter and increasing the loss of head and, in the case of mechanical filters, the quantity of wash water required. Interesting examples of this are the mechanical filter plants at Cincinnati and Louisville on the Ohio River, and at the sand filter at Wilmington, Del.

**The Proper Function of the Copper Treatment.**—The use of copper sulphate for protecting a water-supply against algæ troubles should not be regarded as a permanent remedy or one that is to be continuously used. Rather it is a palliative, to be used under exceptional conditions—a very valuable adjunct to our other methods of purifying water.

The question often comes up as to whether copper sulphate may be used in a reservoir from which the water must flow to the consumers almost immediately after treatment. This is usually unwise, as the decaying organisms would be carried into the pipes. If the algæ conditions are so serious as to warrant its use in such a situation the consumers should be warned not to drink the water for several days. If this is done and the copper treatment followed by disinfection with hypochlorites there seems to be no hygienic objection to it.

The copper treatment has been widely used in all parts of the world, and nearly all sanitarians and water-works engineers approve of its intelligent use.

**Creosote Treatment for Algæ Growths.**—Mr. Wm. F. Wilcox, of Meridian, Miss., has stated that the application of creosote to the water in his reservoir in 1910 destroyed the algæ. The

quantity used was one gallon per acre of water surface, which was equivalent to about 0.5 part per million. The method has not been used elsewhere, so far as the author knows.

**Hypochlorite Treatment for Algæ.**—Algæ may be killed by the use of hypochlorite, but just as this substance is better than copper sulphate for bacterial disinfection so the copper treatment is generally better than hypochlorites for the destruction of algæ.

**By-passes.**—It often happens that a water-works system is so arranged that a reservoir can be cut out of service if the water in it becomes affected with growths of algæ. When a reservoir is thus allowed to remain standing the organisms sometimes disappear in the course of a short time. This cannot always be depended upon. Reservoirs thus isolated sometimes remain in a foul condition for many months. In case an open reservoir is used for the storage of ground-water, it should be provided with a by-pass in order that this method of isolation may be resorted to in case of need.

The by-pass around the Ridgewood reservoir in Brooklyn, was of great service, prior to the use of copper sulphate. The by-pass also gives opportunity for the reservoir to be shut off while the copper treatment is being given, thus avoiding the temporary unpleasant effects due to the decomposition of the algæ.

## CHAPTER XVII

### PURIFICATION OF WATER CONTAINING ALGÆ

THE keynote of success in purifying water which contains algæ is *aeration*. By this is meant the exposure of water to the air in thin films, in drops or as a fine spray. The object is to provide opportunity for an interchange of gases between the water and the air, so that oxygen may be dissolved and carbonic acid and odoriferous gases, such as sulphureted hydrogen and the like, may be liberated. Aeration alone sometimes greatly improves the quality of water which has a bad taste and odor caused by algæ, but usually it is to be regarded as an adjunct to filtration; for while aeration may reduce the odor it does not remove the organisms themselves.

The aeration of water has been practised for many years. At one time it was thought to improve the hygienic condition of the water, but bacteriological studies have shown that the bacteria are not destroyed to any extent by the process. One of the early instances of the application of aeration was in the reservoirs of the Hackensack Water Company in New Jersey, where air was blown in through perforated pipes placed near the bottom. It is said to have produced beneficial results, but, as applied, it was a one-sided process. Oxygen was forced in, but there was very little opportunity for carbonic acid or odoriferous gases to be liberated. The natural aeration that occurs when water flows down the rocky bed of a brook or over water-falls has been repeatedly found to be of benefit in reducing odors. The mechanical agitation tends to disinte-

grate the organisms, the repeated exposure of the water to the air liberates the odoriferous substances, and the absorption of air provides oxygen for oxidation processes. A similar disintegration of the organisms may take place in the pipes of a distribution system, but in this case there is no chance for the odoriferous substances to be lost, and the disintegration of the organisms, may only intensify the odor of the water.

**Experiments on Aeration.**—In 1907 some experiments were made by the author, assisted by Mr. Melville C. Whipple, at the Polytechnic Institute of Brooklyn, N. Y., for Messrs. Hazen and Fuller in connection with their report to the New York Board of Water Supply. Deaerated water was exposed to the air in various receptacles and by causing it to fall through the air as drops, and the rate of oxygen absorption determined. Water containing carbonic acid was similarly tested and the rate of decarbonation ascertained. Water charged with sulphureted hydrogen, oil of peppermint and other essential oils were also used. Some of the results of these experiments were published in the Journal of the New England Water Works Association, 1913, Vol. XXVII, No. 2, p. 193.

In brief it was found that an exposure of water to the air in drops for a period of one second would increase the dissolved oxygen from 0 per cent up to about 75 per cent of saturation, and an exposure of two seconds would increase it to about 90 per cent.

Carbonic acid was reduced after exposure in drops, as shown by the following figures, which give the quantity left in solution after different intervals of time.

CARBONIC ACID LEFT IN SOLUTION AFTER AERATION

	Carbonic Acid (Parts per Million).			
At the start.....	5.0	10.0	25.0	50.0
After 0.5 second.....	4.1	6.9	13.8	23.4
“ 1 “ .....	3.5	5.3	9.3	14.0
“ 2 “ .....	3.0	4.1	6.2	8.5
“ 5 “ .....	2.5	3.0	3.8	4.5
“ 15 “ .....	2.1	2.1	2.1	2.1

Sulphureted hydrogen was reduced as follows:

SULPHURETED HYDROGEN AFTER AERATION

Time.	Sulphureted Hydrogen. (Parts per Million.)	Odor.
At start.....	15.2	Faint
After 1 second....	10.2	Very faint
After 1.5 seconds..	5.0	Very faint
After 2.0 seconds..	2.6	None

The oil of peppermint gave a distinct odor when diluted in water to the extent of one in one million; and could be detected when diluted to one in fifty million. On exposure to the air in drops the odors decreased as follows:

ODOR AFTER AERATION

	Odor of Peppermint.		
	1	2	3
At start.....	Distinct	Faint	Very faint
After 1 second.....	Distinct	Faint	Very faint
After 1.5 seconds.....	Distinct	Very faint	None
After 2.0 seconds.....	Faint	None	None

**Natural Aeration by Falling over a Dam.**—Forbes and Richardson in their studies of the Illinois River have shown that at the Marseilles Dam in July and August, 1911, the dissolved oxygen increased from 0.64 to 2.94 parts per million, or four and a half times, during the fall. In winter, when the volume of water was larger, the increase was only 18 percent, namely from 7.35 to 8.65 parts per million. The carbonic acid during the summer decreased from 8.2 to 6.48 parts per million.

**Aerating Fountains.**—At Rochester, N. Y., West Point and many other places that might be named, the water entering the reservoir has been allowed to flow through an upturned nozzle so as to produce a fountain. This is often productive of substantial benefit to the water. An example of an aerating fountain is shown in Fig. 62, which represents the manner in which the stagnant water at the bottom of one of the reser-



FIG. 62.—View Below the Sodom Dam of the Croton Water Supply of New York City, Showing Aeration. Photograph by Pullis.

voirs of the Croton supply is oxygenated as it is discharged into the stream below the dam. The ferrous iron which the water contains is oxidized in this way, and the resulting ferric hydrate becomes deposited on the stones in the stream to such an extent as to color them brownish-red.

The frontispiece shows the aerating fountain at the West Parish filter of the water-supply of Springfield, Mass., which was constructed in 1909, the Consulting Engineers being Hazen and Whipple and the Chief Engineer being Mr. Elbert E. Lochridge, to whom the author is indebted for the photograph. If this fountain be compared with the jet shown in Fig. 62, the advantage of the multiple outlet will be evident.

Another example of aeration is at the filter plant at Albany, N. Y. designed by Allen Hazen in 1899. This serves to eliminate odors from the polluted water of the Hudson River and also to remove carbonic acid, thus helping to prevent growths of organisms in the settling basin into which the aerated water is discharged.

Aerating fountains are capable of artistic treatment and they always add to the attractive appearance of a reservoir. The enjoyment of watching falling water seems to be instinctive. The effect of aeration in liberating odors from water is often shown by the odors which pervade the air in the vicinity of fountains, when the water contains algæ. Even the spray at Niagara Falls at times has an odor of decomposition due in part to the sewage pollution which the river receives at Buffalo and elsewhere.

**Aerating Nozzles.**—The use of aerating nozzles and other devices for oxidizing sewage in connection with percolating filters, or sprinkling filters, seems likely to cause a decided advance in the art of aerating water. Fig. 65 shows the aeration of sewage at Baltimore, Md. Sprays of a new design have been put in operation at the Kensico supply of the New York supply. They are of interest as they involve the use of a rifled nozzle, which gives a whirling motion to the discharged spray. This aerator is shown in Figs. 67 and 68. A much larger plant of this kind is to be used for the new Catskill supply.



FIG. 63.—Spillway of the Croton Dam, Showing Natural Aeration.



FIG. 64.—Aerators at the Albany Filtration Plant. Designed by Allen Hazen.



FIG. 65.—Sprinkling Filters, at Baltimore Sewage Disposal Works.



FIG. 66.—Aerator at the Ludlow Filter, Springfield, Mass.



FIG. 67.—Aerator at Rye Pond. Borough of the Bronx, New York City.



FIG. 68.—Aerator at Rye Pond. Borough of the Bronx, New York City.

**Aeration by Percolation.**—Aeration is much used in connection with the removal of iron from public water-supplies. A common method is to allow the water to trickle slowly downward through porous beds—such as broken stone, coke, shavings—or to fall through perforated plates. These methods serve to retard the flow of the divided water, so as to give a longer period of exposure of the water to the air. When these methods are used it is important to have the beds themselves well ventilated.

**Filtration of Water Containing Small Numbers of Algæ.**—When water contains few algæ it may be filtered by either sand filtration or mechanical filtration. Usually the choice of method is determined by other considerations than the presence of organisms, except when the amount of algæ is large. In both systems the presence of organisms tends to clog the filters and increase the loss of lead.

**Growth of Algæ on Open Sand Filters.**—When water is filtered through open sand filters where the sand surface is always covered with water, as in continuous filtration, algæ grow upon the sand surface. That this is a growth and not a mere accumulation was shown by some experiments made by the author many years ago at Chestnut Hill reservoir.

An experimental filter became so clogged after running for 25 days that it was necessary to scrape the surface of the sand. Microscopical examinations showed that over each square centimeter there were 2,500,000 *Tabellaria* and 1,000,000 *Synedra*, besides many other microscopic organisms. Calculations from the analyses of the raw water showed that during the 25 days when the filter had been in operation only 150,000 *Tabellaria* and 20,000 *Synedra* were removed from the water by each square centimeter of the filter. The difference between the two sets of figures represents the growth of organisms upon the sand. Samples of scum taken from various filters in practical operation have shown the presence of microscopic organisms in numbers which range from a few thousand to several million per square centimeter of surface area. The presence of these organisms aids filtration in a certain sense

by forming a tenacious surface scum over the sand. This schmutzdecke, however, forms even without their presence, and accumulations of organisms above the sand are, on the whole, likely to do more harm than good. They cause the filter to clog more quickly than it otherwise would, and, therefore, increase the cost of operation. Furthermore, when open filters are used these algæ growths sometimes interfere with filtration in another way. When their growth is vigorous the amount of gas liberated from them sometimes becomes so great that masses of the organisms are lifted from the sand layer and floated to the surface. Spots of sand are, therefore, left uncovered, and the water filters through them, more rapidly than it should, with the result that filtration is imperfect. It seems probable, also, that decomposition of the organisms at the surface affects the filtered water unfavorably. When filters are covered with roofs these organisms do not grow on the sand surface and those which are found there represent accumulations from the raw water.

**Kemna's Studies at Antwerp.**—Dr. Ad. Kemna made systematic studies of the algæ found in the schmutzdecke every time a filter bed at Hamburg was scraped. A summary of these may be found in a discussion by the author in the Transactions of the Am. Soc. C.E. Vol. XLIII, p. 318, from which the following is quoted.

The organisms which develop over the surface of a sand filter may be grouped, for practical purposes, into three classes: those which form a matting upon the sand; those which are attached to the sand but extend upward in filaments or sheets; and those which are free-floating in the water. Perhaps it would be better to say that the organisms are found in these three conditions, because the same organism is sometimes found now on the sand and now above it.

The effects of these three groups of organisms upon the operation of the filter are not the same. The most important effect is that produced by those organisms which form a matting upon the sand. The diatoms and the unicellular algæ are here chiefly concerned. By their growth they form a more or less

gelatinous film upon the surface, and as this film becomes denser, the rate of filtration is retarded until finally it becomes necessary to scrape the filter. The algæ which grow erect upon the sand do not thus clog the filter. On the contrary, they prevent clogging to some extent. Their waving, interlaced threads act as a sort of preliminary strainer, removing from the applied water some of the suspended matter which would otherwise collect on the sand. This action continues as long as the plants are in good condition and as long as the evolution of gas is sufficient to cause flotation. When they begin to decay or when they become overloaded with foreign matter they settle to the bottom and help to clog the filter. Kemna found that at Antwerp *Hydrodictyon* was the most effective organism in this process of preliminary straining. The free-floating forms have little influence on the rate of filtration as long as they remain in suspension, although, to some extent, they too play a part in the preliminary clarifying process. But ultimately most of them reach the surface of the sand and help to clog the filter.

During the course of the year the character of the flora changes. This change is often gradual, but at times is very rapid. Kemna has noticed that at the time when certain organisms are rapidly disappearing from the sand the efficiency of filtration is impaired. He attributes this to the changed condition of the surface film caused by the decomposition of the organisms, but suggests that changes in the bacterial flora may also play an important part. In a recent publication he cites the following interesting experience with *Anabæna*:

During the hot weather of July, 1899, *Anabæna* became abundant over some of the Antwerp filter beds. Knowing the character of this organism and its tendency to impart an odor to the water, he kept a careful watch of the filters, collecting samples of the filtered water twice a day and testing them as to their odor and the amount of ammonia they contained. As long as the *Anabæna* remained in a living condition in the water over the sand, the filtered water was satisfactory, but when the organisms disappeared, on the advent of cold weather, the

filtered water acquired a bad taste and the amount of ammonia increased.

The studies made at Hamburg and at Antwerp show, with apparent conclusiveness, that when the vegetation over a sand filter is in a living condition, it is a positive aid to the efficiency of filtration, though it increases the cost of operation. Most of the microscopic organisms have a coating which is somewhat gelatinous, and in many cases the gelatinous material is very abundant. The diatoms and other organisms which grow directly on the sand aid in the formation of the surface film on which the efficiency of filtration largely, but not solely, depends. This fact has been understood for many years. The surface film forms through bacterial agency on covered filters as well as on open filters, but on the latter its formation is assisted by the microscopic organisms.

**Examination of Filter Scum.**—As an example of the number of organisms that may be found upon the surface of an open sand filter, the following table is taken from the records of an experimental filter at Boston, Mass. The sample was collected in March after the filter had been in operation two months.

	Number of Organisms over 1 Sq. Cm. of Sand. (In Standard Units.*)
<i>Diatomaceæ:</i>	
Asterionella.....	278,000
Cymbella.....	130,000
Diatomâ.....	150,000
Melosira.....	10,000
Meridion.....	25,000
Navicula.....	7,700
Stephanodiscus.....	6,500
Synedra.....	1,100,000
Tabellaria.....	2,390,000
<i>Chlorophyceæ:</i>	
Closterium.....	1,200
Scenedesmus.....	800
Protococcus.....	60,500
Conferva.....	12,000
Spirogyra.....	5,500

\* One standard unit equals 400 square microns.

<i>Cyanophyceæ:</i>	
Chroococcus.....	5,300
Oscillaria.....	84,000
 <i>Protozoa:</i>	
Trachelomonas.....	16,000
Ciliata.....	5,000
Peridinium.....	4,000
Tintinnus.....	14,000
Mallomonas.....	800
Synura.....	6,000
Codonella.....	400
 <i>Rotifera:</i>	
Annuræa.....	800
Polyarthra.....	1,000
Synchæta.....	8,000
<hr/>	
Total organisms.....	4,324,500
Amorphous matter.....	2,300,000

**Crenothrix Growths in Sand Filters.**—Where water is filtered through sand filters and there is a deficiency of oxygen by reason of the presence of too much organic matter undergoing decomposition, it often happens that iron is reduced within the filter, going into solution and appearing in the effluent. Under these conditions growths of *Crenothrix* often occur in the underdrains and may even produce clogging by their vigorous development.

**Filtration of Water Containing Large Numbers of Algæ.**—Where the algæ growth in water is excessive it is impossible to satisfactorily filter the water by the ordinary methods. Aeration is a necessity. Sometimes it has to be used not only before, but after filtration in order to keep the oxygen from becoming exhausted. In fact sometimes the quantity of algæ is so great that the oxygen will be exhausted before the water has had a chance to reach the bottom of the sand bed.

In this case continuous filtration becomes impracticable and intermittent filtration necessary. The latter method is that which has been used so commonly for sewage purification.

**The Ludlow Filter.**—Perhaps the best illustration of intermittent filtration applied to the purification of water contain-

ing algæ was the Ludlow filter at Springfield, Mass., designed in 1905. A description of this filter may be found in the journal of the New England Water Works Association for 1907, Vol. XXI, p. 279.

This filter was built cheaply for temporary service by leveling a mound of sand, so as to obtain a flat area of four acres. This was divided into four beds enclosed by earth embankments. The water was pumped from the reservoir to an aerator in the center of the plant, from which it was intermittently applied to the different beds. Tiles 6 in. and 8 in. in diameter were laid  $12\frac{1}{2}$  ft. apart, to serve as underdrains. The sand was 5 ft. deep and had an effective size of 0.30 mm. The aerator shown in Fig. 66, was a novel feature of the plant. The filtered water was further aerated by falling from the small drains into a large drain and thence into a wooden flume.

This filter did good service for several years and until the supply was abandoned for the new supply from the Little River.

**Double Filtration for Water Containing Algæ.**—Double filtration was tried experimentally at Springfield by the Massachusetts State Board of Health before the Ludlow filter was built. The results of these experiments were summed up in the chemist's report as follows:

“Summarizing the discussions upon this point given upon previous pages, it has been found that practically all positive odors were removed by single filtration except during the period of high numbers of *Anabæna* and fermentation of organic matter in the reservoir. During this period single filtration through sand filters at rates of 2,500,000 and 5,000,000 gallons per acre daily failed to remove the odors, but double filtration, even with the secondary filter operating at a rate of 10,000,000 gallons per acre daily, was entirely successful in removing all odors remaining in the water that had passed through the primary filter, although this primary filter was poorly operated at this time. This result was aided by the aeration of the water before passing to the surface of the secondary filter.”

Double filtration with liberal aeration has also been used

for treating waters of this class, notably at South Norwalk, Conn., and at Mt. Desert, Me. H. W. Clark, the Chemist of the Massachusetts State Board of Health was the designer of both plants.

**Copper Treatment Prior to Filtration.** This subject is discussed in Chapter XVI.

**House Filters.**—The use of house filters at the faucet for removing microscopic organisms is quite common. Some of these filters give reasonably satisfactory results if properly cared for, but generally their use is not to be recommended for sanitary reasons. Porcelain or stone filters, such as the Gate City filter, the Pasteur filter and the Berkefeld filter, remove the microscopic organisms completely, but they do not remove all of the odors produced by them. They also improve the sanitary quality of the water, but they clog rapidly and yield but little water.

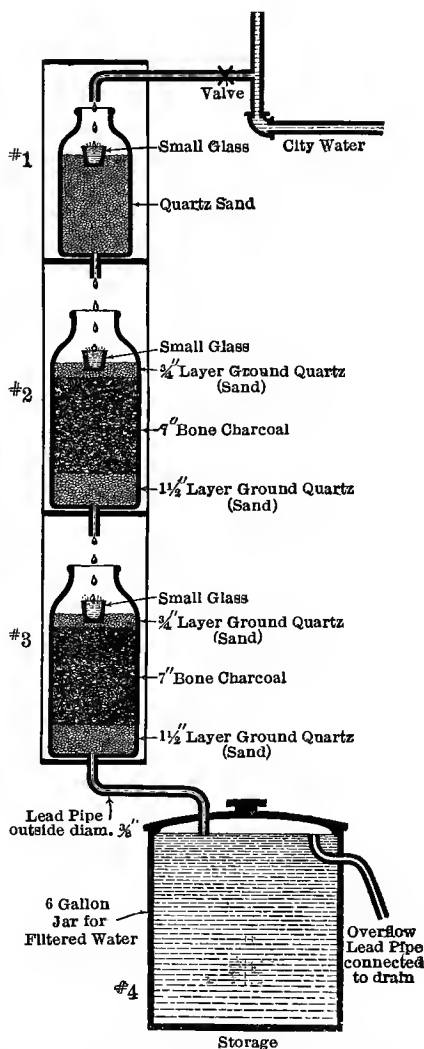

FIG. 69.—Newcomb Filter for Purifying Water for the Household.

A filter of this type, combining aeration and decolorization with charcoal, was much used at Springfield, Mass., in the days of the old Ludlow supply.

Charcoal filters remove the odor as well as the organisms, but for sanitary reasons they are more objectionable than the other types. In certain cases the use of sand and charcoal with liberal aeration of the water gives reasonably satisfactory results. The Newcomb filter has been used at Springfield with satisfactory results. A filter of this type can be made by anyone who has any ingenuity. In general, however, methods of house filtration prove expensive and disappointing.

## CHAPTER XVIII

### GROWTH OF ORGANISMS IN WATER-PIPES

THE reactions between the water and the water-pipes of a water-works system involve principally such matters as iron-rusting, tuberculation, lead-poisoning, and others of a chemical<sup>1</sup> and physical nature, but there are also biological

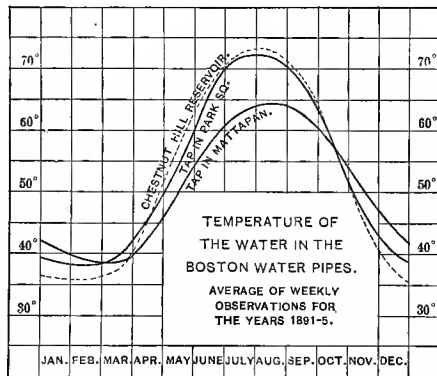

FIG. 70.

reactions. These may be considered under two heads: (1) the effect of the aqueducts and pipes upon the water, and (2) the effect of the water upon the organisms on the walls of the aqueducts and pipes.

**Temperature Changes in Distribution Pipes.**—The temperature of water changes during its passage through the pipes of a distribution system. The nature of these changes is shown by Fig. 70, where the curves represent the averages of weekly temperature observations for five years at Chestnut Hill reservoir and at two taps, one at Park Square, 5 miles from the reservoir and the other at Mattapan, 11 miles from the reservoir. Dur-

ing the spring and summer the water grows cooler as it passes through the pipes, and during the autumn and winter it grows warmer. The maximum temperature at Mattapan is never as high as that at Park Square, but the minimum temperature is about the same at both places, though it occurs later in the season at Mattapan.

**Reduction of Organisms in Pipes.**—Samples taken at the same places serve to illustrate the changes that take place in the organisms of the water due to their passage through the pipes. Weekly observations for five years (1891-5) showed the following average number of organisms present:

	Number of Standard Organisms.	Units per c.c. Amorphous Matter.
Chestnut Hill Reservoir .	248	222
Brookline Reservoir. . . . .	215	212
Tap in Park Square. . . . .	189	190
Tap in Mattapan. . . . .	81	105

The greatest reduction did not occur near the reservoirs, where the pipes were large and the currents swift and constant, but at the extremities of the distribution system, where the pipes were smaller and where during the night the velocities were reduced.

The observations showed that during the winter, when there were comparatively few organisms in the water, the reduction in the pipes was much less than during the summer, when organisms were more abundant. During the six months of the year, from November to April, there was a reduction of 44 per cent in organisms and 24 per cent in amorphous matter in about 6 miles of pipe; while during the six months from May to October the reduction was 62 per cent for the organisms and 53 per cent for the amorphous matter. It is worth noting that the reduction in organisms was greater than the reduction in amorphous matter.

Not only are the microscopic organisms and amorphous matter reduced in the pipes, but the bacteria also tend to decrease. This fact has been observed in many cities. In the pipes of the Boston Water Works the decrease does not occur throughout the entire year. In the summer, when the

temperature of the water is high and when the organisms in the water and those growing in the pipes are passing rapidly through stages of growth and decay, there is a considerable increase. This is shown in Fig. 71.

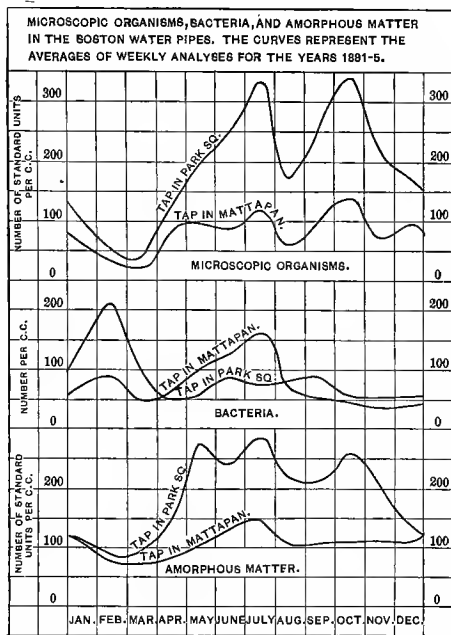

FIG. 71.

In order to determine what organisms showed the greatest reduction in the pipes, a detailed study of the examinations above referred to was made for the years 1892 and 1893. The following were the results:

PERCENTAGE REDUCTION OF MICROSCOPIC ORGANISMS IN THE DISTRIBUTION-PIPES BETWEEN PARK SQUARE AND MATTAPAN, BOSTON, MASS.

	Average for the years 1892 and 1893.
Diatomaceæ.....	58 per cent.
Chlorophyceæ.....	57 " "
Cyanophyceæ.....	54 " "
Protozoa.....	64 " "
Miscellaneous.....	58 " "
Organisms of all kinds.....	56 " "

**Cause of Reduction of Organisms in Pipes.**—Questions naturally arise as to the cause and effect of this reduction of organisms in the pipes. They may be considered under the following topics: sedimentation, disintegration, decomposition, and consumption by other organisms.

Most of the microscopic organisms are heavier than water. Some always settle in quiet water, and they do so in the pipes whenever the current is reduced to a certain point. Others, which in ponds usually rise to the surface on account of the gas bubbles which they contain, will settle in the pipes when the pressure of the water has deprived them of their gas. In dead ends the organisms and particles of amorphous matter often accumulate and form deposits upon the bottom of the pipes. They also tend to deposit on up-grades. It is a matter of frequent observation that the water from the high points of a distribution system contains fewer organisms than that from the low points. The same fact has been observed in high buildings, where the difference between the water on the upper stories and that on the lower floor is often considerable.

The colors of the organisms often change in the pipes of a distribution system. For example the color of *Tabellaria* and other diatoms may be yellowish-brown in the reservoir but greenish-brown in the pipes.

Many of the common organisms are very fragile. Even a slight agitation of the water will break them up. This is particularly true of certain Protozoa, but it also happens to the siliceous cells of diatoms.

The organisms found in surface-waters are accustomed to live in the light. When they enter the dark pipes they are liable to die and decompose. This is particularly true of some of the organisms that are abundant in the summer. Microscopical examination of samples from the service-taps has often revealed organisms in a decomposing condition, swarming with bacteria. This decomposition tends to reduce the numbers of organisms in the pipes.

Another important consideration in the reduction of organisms is the fact that in many of the distribution systems where

surface-waters are used the pipes are covered with growths of sponge, etc. These attached growths depend for their food-material upon the minute organisms found in the water. If the growths are abundant, the removal of organisms from the water by this means may be considerable.

**Pipe Moss.**—Comparatively little has been written in this country upon the biology of aqueducts and pipes. Our attention has been called to growths of *Crenothrix* and of fresh-water sponge, but no attempt has been made to give an accurate account of the organisms infesting the distribution systems of our water-supplies. In Europe, however, the subject has been considered to some extent.

In the city of Hamburg the minute animals inhabiting water-pipes were studied by Hartwig Petersen in 1876. Ten years later Karl Kraepelin made a more extended study. His observations were of much interest. He found an animal growth, often more than one centimeter thick, covering the entire surface of the pipes. The composition of this growth varied in different places. He gave a list of sixty different species observed. In many places the walls of the pipes were covered with fresh-water sponges, chiefly *Spongilla fluviatilis* and *Spongilla lacustris*. Mollusks were conspicuous, especially the mussel, *Dreysena polymorpha*. Snails were also numerous. Hundreds of "water-lice" (*Asellus aquaticus*) and "water-crabs" (*Gammarus pulex*) were found at every examination. The material known as "pipe-moss" was common, and consisted largely of *Cordylophora lacustris* and the Bryozoa, *Plumatella* and *Paludicella*.

**The Rotterdam "Water Calamity."**—At the time when *Crenothrix* was giving so much trouble at Rotterdam, Hugo de Vries made an extended study of the animals and plants found in the water-pipes of that city. His observations were confined chiefly to the pipes and canals which conveyed the unfiltered water of the river *Maas* to the filter beds. In speaking of one of the canals he said: "The walls were thickly covered with living organisms up to the water-level. They formed an almost continuous coating of varying composition.

There were only one or two exceptions to this. In one place, where the water came from the pumps with great velocity, the walls were free from living organisms; and in another place, where there was almost no current, only one living form was seen. There was a section of one of the canals, where a gentle current was flowing, that was a magnificent aquarium. The walls were everywhere covered with white tufts of fresh-water sponge, *Spongilla fluviatilis*. Many of these tufts reached a diameter of 6 or 8 inches, but most of them were somewhat smaller. Between the sponge patches were seated countless numbers of the mussel, *Dreyssean polymorpha*. Individuals old and young were often seen grouped together in colonies which sometimes extended completely over the sponges. But what most of all attracted attention was a luxuriant growth of the 'horn-polyp,' *Cordylophora lacustris*. It covered the mussel-shells and occupied all the space between the sponges. The stalks reached a length of an inch or more. On and between the *Cordylophora* swarmed countless numbers of *Vorticella*, *Acineta*, and other Protozoa and Rotifera. These organisms had no lack of food-material, and the absence of light protected them from many foes which, in the light, thin out their ranks. Over all these animals *Crenothrix* was found growing in abundance. The shells of the mussels and the stems of the 'horn-polyps' were coated with a thick felt-like layer of these 'iron-bacteria.' In other localities in the pipes the place of the 'horn-polyps' was occupied by the Bryozoa, or 'Moss-animalcules.' All of these branching forms were spoken of collectively by the workmen as 'pipe-moss.'"

**Boston Experience.**—In the summer of 1896, when the pipes of the Metropolitan Water Works were being laid in Beacon Street, Boston, near the Chestnut Hill reservoir, a 16-inch main leading from the Fisher Hill reservoir to the Brighton district was opened. This afforded an opportunity to examine the material on the inside of a pipe that had been laid ten years. Inspection showed that besides the usual coating of iron-rust, tubercles, etc., there were numerous patches of fresh-water sponge, both *Spongilla* and *Meyenia*, brownish or almost white

in color, and about the size of the palm of one's hand. What was most conspicuous, however, was a sort of brown matting which covered much larger areas, and which had a thickness of about  $\frac{1}{4}$  inch. It had a very rough surface and, when dried, reminded one of a piece of coarse burlap. This proved to be an animal form belonging to the Bryozoa, known as *Fredericella*. As fragments of it had several times before been observed in the water from the service-taps, and as it had been seen growing in some small pipes connected with the filtration experiments at the Chestnut Hill reservoir, more extended observations were made in different parts of the distribution system.

These brought out the fact that sponges and the Bryozoa were well established in the pipes. Many other organisms were also observed. In some places almost pure cultures of *Stentor* and *Zoothamnium* were found. At other points hosts of different organisms were seen, such as snails, mussels, *Hydra*, *Nais*, and *Anguillula*, *Acineta*, *Vorticella*, *Arcella*, *Amoeba*, countless numbers of ciliated infusoria, and many other forms. The growths were distinctly animal in their nature, but in many places parasitic vegetable forms, such as *Achlya*, *Crenothrix*, *Leptothrix*, etc., were common. The most important class of organisms found, however, was the Bryozoa, of which *Fredericella* and *Plumatella* were the chief representatives.

**Food-supply of Pipe-moss.**—The fact that the organisms that dwell in water-pipes depend for their food-material upon the algæ, protozoa, bacteria, etc., contained in the water may be easily demonstrated by experiment. Specimens of *Fredericella* and *Plumatella* were once placed in a series of jars, some of which were supplied with water rich in its microscopic contents, while others were supplied with the same water after filtration. All the jars were kept in semi-darkness at the same temperature, and were examined daily. The *Fredericella* and *Plumatella* that had been supplied with filtered water soon began to die, while those in the other jars lived as long as the experiment was continued. Some of the same Bryozoa were placed in jars furnished with water from the Newton supply,

a ground-water almost free from microscopic organisms, and after about a week they died for want of food. Dr. G. H. Parker of Harvard University once made a similar experiment on fresh-water sponge, and obtained the same result. With these facts established, we may confidently affirm that fresh-water sponge, Bryozoa, and similar pipe-dwellers will be absent from water-pipes where ground-water or water that has been effectively filtered is used.

**Effect of Growths of Organisms in Pipes.**—One naturally asks, "What is the effect of these organisms growing in the pipes?" In a certain sense they tend to improve the quality of the water, by reducing the number of floating microscopic organisms; but they themselves must in time decay, and any one whose nose has ever had an experience with decomposing sponge will appreciate the fact that better places for these organisms may be found than the distribution systems of our water-supplies. It should be stated, however, that in all probability very large quantities would be required to produce tastes or odors that would be noticed in the water. Perhaps the greatest objection to their presence is the fact that they tend to impede the flow of water in the pipes. When one considers that a coating  $\frac{1}{4}$  inch thick diminishes the area of the cross-section of a 24-inch pipe by 4 per cent, and of a 6-inch pipe by 15 per cent, and when one learns that these organisms often form layers even thicker than this, it will be seen that such growths are matters of no little importance. Furthermore, fingers of the fresh-water sponge sometimes extend several inches into the water, and the matting of the Bryozoa is always rough on account of the stiff branches that are extended in order that the organisms may secure their food. This roughness of the surface materially increases the friction of the pipe by a considerable but indefinite amount.

Organisms growing on the inner walls of water-pipes tend to promote tuberculation. This takes place in the following manner: Between the organisms and the walls of the pipe there is a layer of water from which the oxygen is at times temporarily exhausted and in which carbonic acid is abundant, these condi-

tions being brought about by the organisms. If the organisms are torn away the pipe-coating may be removed and a little spot of iron thus exposed to the action of the carbonic acid. Corrosion thus begins and iron oxide becomes deposited in crystalline form around this spot, forming what is known as a tubercle. These tubercles greatly increase the roughness of the pipe and consequently retard the flow of water.

**Experience with Pipe Moss in Brooklyn.**—An interesting experience with pipe moss is on record at the Brooklyn Water Department. In November, 1897, the water in the Mt. Prospect reservoir became so filled with *Asterionella* that it was deemed advisable to shut off the reservoir and pump directly into the pipes. This action was followed by the appearance of brown fibrous masses in the tap-water. In a number of instances this fibrous matting stopped up the taps, and even large pipes were choked. The water at the same time had a distinctly moldy and unpleasant odor. The fibrous matting proved to be *Paludicella*. It had been growing on the inner walls of the pipes, and the change of currents and the pulsations of the pump, due to the direct pumping into the pipes, had dislodged it. Systematic and thorough flushing of the pipes materially improved the conditions.

## PART II

---

### CHAPTER XIX

#### CLASSIFICATION OF THE MICROSCOPIC ORGANISMS

THE microscopic organisms found in drinking water include the lowest forms of life. Some of them belong to the vegetable kingdom, some belong to the animal kingdom, while others possess characteristics that pertain to both. There is in reality no sharp dividing-line between the vegetal and the animal in the low forms of life. Nature's boundaries are always shaded on both sides.

**Classification.**—Classification of organisms into groups is necessary, but it must be borne in mind that all classifications are artificial and subject to change. The one outlined below and used throughout this volume is believed to be the most convenient for the work at hand. Several groups, not pertaining to the microscopical examination of drinking water, are omitted.

#### CLASSIFICATION OF THE MICROSCOPIC ORGANISMS

##### Plants

DIATOMACEÆ.	ALGÆ (in the narrower sense).
SCHIZOPHYCEÆ.	<i>Chlorophyceæ.</i>
<i>Schizomycetes.</i>	FUNGI.
<i>Cyanophyceæ.</i>	VARIOUS HIGHER PLANTS.

**Animals****PROTOZOA.***Rhizopoda.**Mastigophora (Flagellata).**Infusoria* (in the narrower sense).**CRUSTACEA.***Entomostraca.***BRYOZOA (POLYZOA).****SPONGIDÆ.****VARIOUS HIGHER ANIMALS.****ROTIFERA.**

**Conflict of Terminology.**—The word “Algæ” is used so much and is so often applied to all growths of microscopic organisms, whatever their place in nature, that special mention should be made of its true limitations.

Algæ are flowerless plants of simple cellular structure, without mycelia, roots, stems, or leaves. The functions of the plants are centered in the individual cells, and only to a limited extent is there any “division of labor” among the cells. Prof. G. S. West, in his excellent treatise on the British Fresh Water Algæ describes them as follows:

**Algæ.**—Algæ are Thallophytes of a simple or complex structure, and are of a green, yellow-green, blue-green, red or brown color. Most of them live entirely submerged in water and the major portion of them inhabit the sea. They are found floating freely at the surface, attached to stones, or as in a large number of the fresh-water forms, adhering in gelatinous masses to the submerged portions of more highly organized aquatic plants. A few prefer damp situations in which they do not become immersed at all, or only periodically become covered with water.

They are mainly distinguished from the Fungi by the presence of chlorophyll and consequently by their mode of life. Even in the red, brown, and blue-green Algae chlorophyll is present, but the green color is masked by the presence of other coloring-matters. As the coloring-matter is usually the same throughout large groups of these plants which agree in other characters, particularly in the method of reproduction, they are classified as follows:

- Class 1. *Rhodophyceæ* (or the Red Algæ), containing a reddish coloring-matter known as phycoerythrin. Mostly marine.
- Class 2. *Phæophyceæ* (or the Brown Algæ), containing a brown coloring-matter known as phycophæin. Mostly marine.
- Class 3. *Chlorophyceæ* (or the Green Algæ), containing only the green coloring-matter known as chlorophyll. Very largely fresh-water plants. The stored product of assimilation is in allmost all cases starch.
- Class 4. *Heterokontæ* (or the Yellow-green Algæ), containing a large proportion of a yellow pigment known as xanthophyll. The stored product of assimilation is a fatty substance. Fresh-water.
- Class 5. *Bacillariææ* (or the Diatoms), containing a brown coloring-matter diatomin, which much resembles the phycophæin of the brown algæ. Universal both in fresh and salt water.
- Class 6. *Myxophyceæ* (or the Blue-green Algæ), containing a blue coloring-matter known as phycocyanin. The stored product of assimilation is most probably glycogen. Mostly fresh-water.

Dr. West uses the term *Myxophyceæ* in place of the better known term *Cyanophyceæ*. For the sake of avoiding confusion the latter term is retained in the present volume. For the same reason the term *Diatomaceæ* is used instead of *Bacillariaceæ*.

The same writer also includes such organisms as *Dinobryon* and *Synura* in the class, *Phæophyceæ*, or the brown algæ, while Calkins, our greatest American authority on Protozoa, includes them in the Protozoa. The latter seems to be the general practice among those who have studied the organisms from the water-works standpoint. It is well to notice however, that these are examples of organisms about the status of which there is doubt.

**Few Organisms Described.**—Of the many thousands of different species of microscopic organisms found in fresh water

only a few are described in this book. These have been chosen chiefly because of their frequent occurrence and their important influence on the quality of the water in which they are found, but in some instances they have been included as representative of a class or group in order that the attention of the student may be drawn to them. The reader is urged to extend his studies beyond the confines of the present volume.

The description of the organisms is not in many cases carried beyond the genus. To describe the different species belonging to the same genus would have been quite beyond the possibilities of a small work. The reader should remember, however, that under nearly all of the genera mentioned there are a number of common species. Similarly the plates do not include illustrations of all of the species commonly seen.

**Coloring.**—It is difficult to reproduce the colors of the organisms. Those shown on the plates are merely suggestions. The colors often change in the pipes of a distribution system. Diatoms change from brown to greenish-brown. Cyanophyceæ becomes more bluish.

## REFERENCES

- APSTEIN, CARL. Das Plankton des Süßwassers und seine quantitative Bestimmung. Apparate. Schriften d. naturw. Vereins f. Schleswig-Holstein, IX, 267-273.
- APSTEIN, CARL. 1891. Ueber die quantitative Bestimmung des Plankton im Süßwasser in Zacharias' Thier- und Pflanzenwelt des Süßwassers.
- BENNETT and MURRAY. 1889. A Handbook of Cryptogamic Botany. New York: Longmans, Green, & Co.
- BLOCHMANN. 1891. Die mikroskopische Thierwelt des Süßwassers.
- CONN, HERBERT WILLIAM, and WEBSTER, LUCIA WASHBURN (HAZEN). 1908. A preliminary report on the algæ of the fresh waters of Connecticut. Bulletin No. 10, Connecticut geological and natural history survey. Hartford.
- COOKE, M. C. One Thousand Objects for the Microscope. London.
- COOKE, M. C. 1885. Ponds and Ditches. London.
- ENGLER, A., and K. PRANTL. 1896. Die natürlichen Pflanzenfamilien. Teil I. Leipzig.
- EYFERTH, B. 1885. Die einfachsten Lebensformen des Thier- und Pflanzenreiches. Braunschweig.
- GRIFFITH and HENFREY. 1883. The Micrographic Dictionary, 4th edition. London: J. Van Voorst.

- HOKE, R. 1667. *Micrographia, or Some Physiological Descriptions of Minute Bodies, made by Magnifying Glasses, with Observations and Inquiries Thereupon.* London.
- HOOLE, SAMUEL. 1798. *The Select Works of Antony Van Leeuwenhoek, containing his Microscopical Discoveries in many of the Works of Nature.* Translated from the Dutch and Latin editions published by the author. In two volumes. London.
- KIRCHNER und BLOCHMANN. 1891. *Die mikroskopische Pflanzen- und Thierwelt des Süßwassers.* I. Plants. II. Animals. 2d edition. Hamburg.
- KÜTZING, F. G. 1849. *Species Algarum.*
- LAMPERT, KURT. *Das Leben der Binnengewässer.*
- MEZ, CARL. 1898. *Mikroskopische Wasseranalyse.* Berlin: Julius Springer.
- MIGULA, W. 1898. *Synopsis Characearum europæarum.* Leipzig.
- RABENHORST, LUDOVICO. 1864. *Flora Europæa Algarum Aquæ Dulcis et Submarinæ.* Sec. I. Algas Diatomaceas complectens. Sec. 2. Algas Phycochromaceas complectens. Sec. 3, 1-20 Algas Chlorophyllaceas. Secs. 3, 21-29 Melanophyceas et Rodophyceas complectens. Lipsiæ, 1864.
- STOKES, A. C. 1895. *Aquatic Microscopy.* Philadelphia: Queen & Co.
- TIEMANN and GÄRTNER. *Die chemische und mikroskopisch-bakteriologische Untersuchung des Wassers.* Braunschweig: F. Vieweg & Son.
- WARD, HENRY B., and WHIPPLE, G. C. 1914. *Fresh Water Biology.* (*In press.*) New York, John Wiley & Sons, Inc. The latest book on the general subject. Each chapter is written by a specialist.
- WEST, G. S. 1904. *A Treatise on the British Fresh Water Algæ.* Cambridge. At the University Press.
- ZACHARIAS, DR. OTTO. 1891. *Die Tier- und Pflanzenwelt des Süßwassers.* 2 vols. Leipzig. J. J. Weber. (A valuable description of the common microscopic organisms found in fresh water.)
- ZACHARIAS, DR. OTTO. Annually since 1893. *Archiv für Hydrographie u. Planktonkunde.* Stuttgart E. Schweizerbart. (A continuation of the preceding. These volumes contain many important papers by Dr. Zacharias and his associates.)
- ZACHARIAS, DR. OTTO. 1907. *Das Süßwassersplankton.* Leipzig: B. G. Teubner.

(See also page 393.)

## CHAPTER XX

### DIATOMACEÆ

THE Diatomaceæ, or Bacillariæ, comprise a group of minute vegetable forms of a low order. Their exact position in the scale of life has been the subject of much controversy. The early writers considered them to belong to the animal kingdom because of the power of movement that some of them possess. Later, when they had become generally recognized as plants, they were considered as a Class or Order of the Algæ. Some cryptogamists, however, prefer to class them as an independent group, thereby recognizing the fact that they are quite different from most unicellular plants. This difference lies chiefly in the possession of siliceous cell-walls upon which may be observed certain markings that are constant in size and arrangement for each species. The great beauty of these markings, together with the infinite variety in the sizes and shapes of the cells of different species, have long made them objects of special study by microscopists. There are said to be upward of ten thousand species.

**Diatom Cells.**—A diatom cell is constructed like a box. There is a top and a bottom, known as the upper and lower valve, on both of which markings are found. The valves are connected by membranes known as “sutural zones,” “connective membranes,” “girdles,” or, when detached, as “hoops.” There are two of these membranes, one attached to each valve, and they are so arranged that one slides over the other just as the rim of a box-cover fits over the sides. This arrangement may be seen in Plate I, Figs. A, B, and C, where a typical diatom, *Navicula viridis*, is shown in three views.

A represents the valve \* view of the diatom, that is, the view seen when looking directly at the valve or the top of the box. B represents the girdle \* view, the view seen when looking at the connective membrane. C is a cross-section through the diatom.

The upper or outer valve is indicated by *a*, and its connective membrane by *c*. The girdle view shows how this connective membrane of the larger valve fits over a similar one, *c'*, attached to the lower or smaller valve, *b*. These girdles have the power of sliding one upon the other so that the thickness of the diatom, i.e. the distance between the valves, is variable.

The valves of the diatom shown in the figure are covered with furrows or markings, *g*. At the center and at each end there are slight thickenings of the cell-wall, known as nodules. The central one is called the central nodule, *d*, and those at the ends, terminal nodules, *e*, *e*. Between these nodules and extending along the medial line of the valve there is a sort of ridge, *f*, in which there is a furrow called a raphe, or raphé. Through this the living matter of the diatom probably communicates with the outer world. The slit is supposed to be somewhat enlarged at the nodules. The raphé, the nodules, and the markings, taken in connection with the shape and size

\* The terms used by different writers to express these two views of a diatom are very confusing. In the following list the terms under A represent the valve view and those under B the girdle view.

A	B
Valve view.	Girdle view.
Side view.	Front view.
Top view.	Zonal view.
Primary side.	Secondary side.
Secondary side.	Primary side.
Face valvaire.	Face connective.
Vue de profil.	Vue de face.

The terms "side view" and "front view" are those generally used by English and American diatomists, but the author has avoided them as not being in themselves sufficiently clear, and has preferred to use the less euphonious but more self-explanatory terms, "valve view" and "girdle view." In consulting books on diatoms the reader should be careful to note the way in which the two views are designated.

of the valves, are the most important external features of a diatom and are the first to be considered in studying them.

**Shape and Size.**—There is probably no class of unicellular organisms in which the outlines vary more than in those of the diatoms. From the straight line to the circle almost all the geometrical figures may be found. Some of these may be described as circular, oval, oblong, elliptical, saddle-shaped, boat-shaped, triangular, undulate, sigmoid, linear, etc. The variations in shape are most marked in the valve view. The girdle view, as a rule, is more or less rectangular. The valves are usually plane surfaces, with only slight curvatures or undulations. Occasionally the surface is warped as in *Amphiprora* and *Surirella*. As a rule the two valves of a frustule are nearly parallel, but in such forms as *Meridion*, *Gomphonema*, etc., the frustule is wedge-shaped when seen in girdle view. The most varied forms are found in salt or brackish water, and the common fresh-water forms are so simple and so characteristic that the reader will have little difficulty in assigning them their proper generic names. Some genera have the cell divided more or less completely by internal plates, called septa, when fully developed as in *Rhabdonema*; and vittæ, when incomplete as in *Grammatophora*. Some diatoms have external expansions on the margin of the valves. *Surirella*, for example, has thin expansions known as alæ, or wings. When these alæ are imperfectly developed they are called keels. *Nitzschia* for this reason is said to be carinate. These wings or keels usually extend along the border of the raphé. Certain filamentous forms, such as *Melosira*, have processes at the point of attachment. In others these processes are elongated into horns, or bristles.

Diatoms vary in size from the minute *Cyclotella*, less than 10 microns\* in diameter, to such large forms as *Surirella* and *Navicula*, that sometimes are one millimeter long. Some filamentous forms grow to a considerable length—often several feet.

\* One micro-millimeter, or micron ( $\mu$ ), equals .001 millimeter.

**Markings.**—The valves of most diatoms are marked with lines or points. In many cases the lines may be resolved into series of points, pearls, beads, or striæ, when a higher power of the microscope is used. The variations in the number and size of these points and their uniformity in different individuals of the same species make them convenient objects for testing the resolving power of microscopes. The variation in the number of these striæ may be seen from the following table:

	Number of Striæ per Millimeter.	
	Longitudinal.	Transverse.
<i>Epithemia ocellata</i> , Kz. . . . .	800	430
<i>Navicula major</i> , Kz. . . . .	850	630
“ <i>viridiz</i> , Kz. . . . .	2400	720
“ <i>lyra</i> . . . . .	850	1000
<i>Cymbella navicula</i> , Ehb. . . . .	1200	1500
<i>Pleurosigma angulatum</i> , Sm. . . . .	1580	2100
<i>Synedra pulchella</i> , Kz. . . . .	670	2150
<i>Navicula rhomboides</i> . . . . .	1700	2700
<i>Amphipleura pellucida</i> , Ktz. . . . .	3400	3700 to 5200

The extreme minuteness of these points, their various appearances under different conditions, and the difficulty of studying them even with microscopes of the highest magnifying powers, have given rise to many different theories concerning the character of the valves. Some writers insist that the points are elevations; others claim that they are depressions. Recent students agree that the structure is more complex than was formerly considered to be the case. The following conception of M. J. Deby, while perhaps not correct for all cases, is a good illustration of the modern view (see Fig. 72).

“The valves of most diatoms are composed of two layers, between which there are circular or hexagonal cavities bounded by walls of silica. The upper layer is not uniform in thickness, but is thin just above the cavities, and thicker, rising in pointed or rounded prominences, above the intersection of the walls of the cavities. The upper layer is lightly silicified, and the thin portions are easily broken, making openings into the cavities. The lower layer bears varied designs the nature of which has not been well established. What authors have

described as areolæ, pearls, pores, orifices, granular projections, depressions, hexagons, beads, points, etc., are really one and the same thing."

**Cell-contents.**—The frustule of a diatom is somewhat analogous to the shell of a bivalve—the living matter is inside. Just inside the cell-wall there is a thin protoplasmic lining (primordial utricle). This protoplasm sends radiating streams through the cell, and it is possible that a portion of it extends through the openings in the cell-wall and communicates with the outer world. It is this layer of protoplasm also that secretes the silica of the cell-wall. Between the streams of protoplasm (Pl. I, Fig. C) there are what appear to be empty

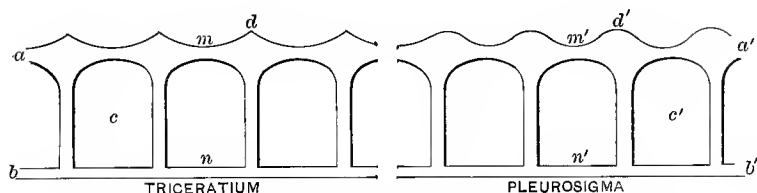

FIG. 72.—Transverse Section of a Diatom Valve. After Deby.

- |                                |                                     |
|--------------------------------|-------------------------------------|
| <i>a.</i> Upper (outer) layer. | <i>d.</i> Inter-alveolar pillars.   |
| <i>b.</i> Lower (inner) layer. | <i>m.</i> Thin part of upper layer. |
| <i>c.</i> Cavities.            | <i>n.</i> Bottom of alveolæ.        |

cavities. In or on the borders of these, oil globules may be sometimes observed. There is a nucleus, and probably a nucleolus, located near the center of the cell. The most conspicuous portion of the cell-contents, however, consists of colored lumps or plates, which are usually constant in appearance and position for any particular species. The brown coloring matter of these "chromatophore plates" is known as diatomin. It is a substance analogous to chlorophyll and has been considered by some writers to be a compound of chlorophyll and phycoxanthin. The spectrum of diatomin is very similar to that of chlorophyll. There are two absorption-bands—one between *B* and *C* in the orange-yellow, and one between *E* and *F* in the indigo-violet. Diatomin is soluble in dilute alcohol, giving a brownish-yellow solution that is some-

times very slightly fluorescent. When dried or treated with concentrated sulphuric acid it assumes a green color. When living diatoms are exposed to the direct rays of the sun or subjected to heat for a considerable time the color of the chromatophore plates changes from brown to green. In certain species other internal features have been noted; namely, the contractile zonal membrane, the germinative dot, double nucleus, etc., but of these there is little known.

**External Secretions.**—Living diatoms are covered with a transparent gelatinous envelope, which is probably a secretion from the protoplasm. In many species it is very thin and can be discerned only by the use of staining agents. In the filamentous and chain-forming species it serves to hold the frustules together. In *Tabellaria*, for example, little lumps of the gelatinous substance may be seen at the corners of the frustules at the point of attachment. Some species secrete great quantities of gelatinous material and are entirely embedded in it. In a few cases it is of a firmer consistency and forms tubes, stalks, or stipes, upon the ends of which the frustules are seated. These stalks attach themselves to stones, wood, etc., immersed in the water.

**Movement.**—Some of the diatoms exhibit the phenomenon of spontaneous movement. This has always excited interest and has been the subject of much speculation. It was the chief argument advanced by the early writers for placing the diatoms in the animal kingdom. The most peculiar movement is that of *Bacillaria paradoxa*, whose frustules slide over each other in a longitudinal direction until they are all but detached, and then stop, reverse their motion, and slide backward in the opposite direction until they are again all but detached. This alternate motion is repeated at quite regular intervals. Some of the free species show the greatest movement, and of these *Navicula* is one of the most interesting. Its motion has been described as “a sudden advance in a straight line, a little hesitation, then other rectilinear movements, and, after a short pause, a return upon nearly the same path by similar movements.” The move-

ment appears to be a mechanical one. The diatoms do not turn aside to avoid obstacles, although their direction is sometimes changed by them. The rapidity of their motion has been calculated to be "400 times their own length in three minutes." Their motion shows the expenditure of considerable force. Objects 50 or 100 times their size are sometimes pushed aside.

**Jackson's Theory of Diatom Movement.**—Various hypotheses have been advanced to account for the movement of diatoms. Naegeli suggested that it was due to endosmotic and exosmotic current; Ehrenberg claimed that the movement was due to cilia; another writer, that it was caused by a snail-like foot outside the frustule; another, that it was due to a layer of protoplasm covering the raphé. H. L. Smith, after much study, came to the conclusion "that the motion of *Naviculæ* is due to injection and expulsion of water, and that these currents are caused by different tensions of the internal membranous sac in the two halves of the frustule."

Jackson has suggested that it is due to the liberation of gases. In a very instructive paper published in the *American Naturalist*, he says:

"The first intimation of the true nature of this motion was suggested by the action of a lithia tablet in a glass of water. The bubbles of carbonic-acid gas given off set up the exact motions in the tablet that have been so often described for the movements of diatoms: A sudden advance in a straight line, a little hesitation, then other rectilinear movements, and, after a short pause, a return upon nearly the same path by similar movements.

"Repeated experiments with compressed pellets evolving gas have shown that this is the usual motion produced by the evolution of gas bubbles, and when pellets were made of the same shape as *Navicula* the movements of these diatoms were perfectly duplicated. Boat-shaped pieces of aluminum two millimeters thick were then made and on them were cut longitudinal grooves to resemble those of the diatom. When placed in strong caustic soda solution the movements of the metal produced by the evolution of hydrogen gas again duplicated those of the diatom in a remarkable manner. The metal having

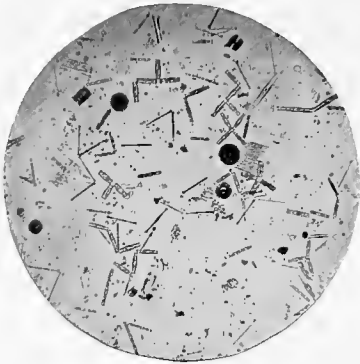
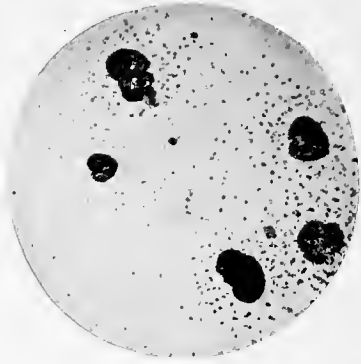
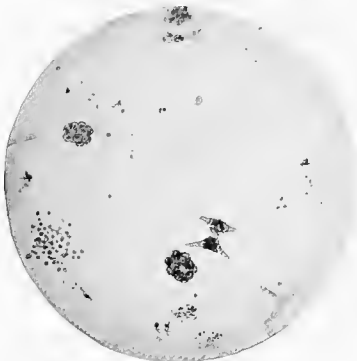
Diatoms.  $\times 75$ .Coelosphaerium.  $\times 100$ .Pandorina and Staurastrum.  $\times 100$ .Microcystis.  $\times 100$ .Clathrocystis.  $\times 100$ .Stigeoclonium.  $\times 100$ .

## PLATE B.

Photomicrographs of Microscopic Organisms Found in Water.  
 (By John W. M. Bunker.)

the grooves had a greater power of motion than that without the grooves.

“ If we consider that the diatom contains chlorophyll bands which when exposed to a strong light rapidly evolve oxygen, and if we take into account the fact that the motion does not take place unless the light is fairly strong, we have then a conception of the true nature of the movements of these organisms.

“ Streams of oxygen may be readily seen evolving from all parts of many of the larger aquatic plants when submerged in water and exposed to strong light, but in the diatom while the gas produced is large in amount compared with the size of the organism, the actual amount evolved is so small that it is taken into solution almost immediately. That such evolution takes place, however, is shown by Professor Smith's experiments with indigo. If now we examine the artificial diatom made of aluminum and placed in strong caustic solution we find that the bubbles from all sides come together and rise in a line corresponding to the median line or raphé of the organism, and that if indigo is placed in the liquid it collects and rotates near the central nodule just as described by Professor Smith to prove his theory of the presence of water currents.

“ It is therefore evident that the motion of diatoms is caused by the impelling force of the bubbles of oxygen evolved, and that the direction of the movement is due to the relatively larger amount of oxygen set free first from the forward and then from the rear half of the organism. This accounts for the hesitancy and irregular movements as well as the motion forward and backward over the same course.

“ The evolving gas seems to act at times as a propeller to push the organism forward and at other times to exert a pulling action to raise the growth on end. The various movements described are the resultants of varying proportions of both of these active forces.

“ The fact that a longitudinal groove on the under side of the artificial diatom causes it to become more active, due to the expulsion of the gas along the line of the groove, explains the greater activity of the Raphideæ.

“ The most interesting and peculiar movements among diatoms are those of *Bacillaria paradoxa* whose frustules slide over each other in a longitudinal direction until they are all but detached and then stop, reverse their motion and slide back again in the opposite direction until they are again almost separated. When the diatoms are active, these alternating movements take place with very considerable regularity. It

is probable that the individuals in a group of Bacillaria are joined together much more loosely than other laterally attached genera and that when a forward movement takes place in the outer individual it is arrested by capillarity just before the diatom is completely detached.

“It can now be readily seen that the strange movements of the other microscopic plants may be explained as also due to the evolution of oxygen gas. While the movements of desmids are not as strongly marked as those of diatoms, many of them, notably *Penium* and *Closterium*, have often been described as having a power of independent motion, and Stahl found that this motion is greatly affected by light.

“The best account of the movements of desmids has been given by Klebs. This author speaks of four kinds of movements in desmids, viz.:

“(1) A forward motion on the surface, one end of each cell touching the bottom, while the other end is more or less elevated and oscillates backward and forward.

“(2) An elevation in a vertical direction from the substratum, the free end making wide circular movements.

“(3) A similar motion, followed by an alternate sinking of the free end and elevation of the other end.

“(4) An oblique elevation, so that both ends touch the bottom—lateral movements in this position; then an elevation and circular motion of one end and a sinking again to an oblique or horizontal position.

“This observer considered these movements to be due to an exudation of mucilage, and the first two to the formation, during the action, of a filament of mucilage by which the desmid is temporarily attached to the bottom and which gradually lengthens.

“These four kinds of movements are very easily explained by the theory of the evolution of gas, and by regulating the conditions they can be exactly reproduced in the artificial desmids made of aluminum. In this case strips of thin aluminum foil should be used. When the gas production is very strong at one end, the desmid will be raised to a vertical position and will take up oscillating or circular movements.

“If we now pass to a consideration of like movements in the *Cyanophyceæ*, the same explanation holds true for *Oscillaria* which often takes up a waving or circular motion when attached at one end. This movement is well described by Griffith and Henfrey \* as follows:

\* *Micrographic Dictionary*, p. 561.

“The ends of the filaments emerge from their sheaths, the young extremities being apparently devoid of their coat; their ends wave backward and forward, somewhat as the forepart of the bodies of certain caterpillars are waved when they stand on their prolegs with the head reared up. The authors attribute this motion to ‘irregular contraction of the different parts of the protoplasm.’

“The free-swimming species of *Nostoc* all have a spontaneous power of active motion in water, and in all of the filiform orders of the *Cyanophyceæ*, detached portions of the filament known as hormogones also have the power of spontaneous motion. All of these movements can be exactly duplicated with lithia tablets in water or with aluminum of the proper weight and shape immersed in strong caustic solution and are also undoubtedly caused by the strong evolution of oxygen gas due to the activity of the chlorophyll present in the organisms.”

**Multiplication.**—Diatoms multiply by a process of halving or splitting, the Greek word for which gives rise to the name *diatom*. The cell-division is similar to that in all plants, but in this case the process is of especial interest because of the rigid character of the cell-walls.

The process begins by a division of the nucleus and nucleolus. The protoplasm expands or increases in bulk, forcing the valves apart, the hoops sliding one out of the other. The two halves of the nucleus separate, the diatomin collects at either side, and a membrane forms, dividing the cell into two parts. Finally the two parts separate. The newly formed membrane becomes charged with silica, making a new valve, and soon after its hoop develops. This process is well illustrated by a drawing of M. J. Deby, shown on Pl. I, Figs. D, E and F. Sometimes the frustules separate entirely; sometimes they remain attached forming filaments, as in *Melosira*, bands as in *Fragilaria*, or zigzag chains as in *Tabellaria*.

The above is the usually accepted theory of cell-division. It is probably correct in many, if not in most cases. It assumes that the siliceous walls are not able to expand, and the result is that after repeated division the frustules become smaller. It is claimed that in some cases the cell-wall does

expand, and therefore that the size of the frustules does not decrease after division.

The generally accepted theory of cell-division assumes that a diatom frustule has two valves, one the larger and older, and the other the smaller and younger. After division two cells are formed, one equal in size to the larger valve and the other equal to the smaller one, the difference in size being twice the thickness of the hoop. This theory also assumes that both the mother- and the daughter-cell have the power of further division. From these assumptions certain laws of multiplication may be deduced. For example: If  $A$  is the parent cell,

After one period of time, $t$ , $A$	will have produced	$B$ ;
“ two periods “ “ $2t$ , $A$	“ “ “	$B'$ ,
	and $B$	“ “ “ $C$ ;
“ three “ “ “ $3t$ , $A$	“ “ “	$B''$ ,
	$B$	“ “ “ $C''$ ,
	$B'$	“ “ “ $C'$ ,
	$C$	“ “ “ $D$ ;

and so on.

From this it happens that

After $t$ we have	$1A + 1B$ ;
“ $2t$ “ “	$1A + 2B + C$ ;
“ $3t$ “ “	$1A + 3B + 3C + D$ ;

and so on.

The laws may be expressed mathematically as follows:

1. As the number of periods of division increases in arithmetical progression the total number of frustules increases in geometrical progression.

2. The number of frustules equal in size after any period of division are represented by the terms of the binomial theorem  $(a + b)^n$ , where  $a$  and  $b$  are unity.

These laws have been demonstrated experimentally, the first by the author and the second by Miquel.

**Reproduction.**—The continued process of multiplication results in a constant diminution in the size of the frustules. After a certain minimum limit of size has been reached or after their power of multiplication has become exhausted, a reproductive process takes place. Usually this consists of a conjugation which results in the formation of a large cell, or auxospore, capable of reproducing a frustule of large size which, by multiplication, gives rise to a new series of frustules like the first. This theory, known as "Pfitzer's Auxospore Theory," was advanced in 1871. Count Castracane has shown that its application is not universal, and that in the case of some diatoms reproduction takes place through the formation of spores, or "gonids," which become fertilized by conjugation and, after a period of repose, attain a condition for living an independent life and reproducing in every respect the adult type of mother-cell. The author has observed these spore-like bodies in the cells of *Asterionella*.

There are few reliable data to be found in regard to the reproduction of diatoms. True conjugation has been observed in comparatively few genera. It is believed that there are four methods of conjugation. *First*, a single frustule, self-fertilized, producing one sporangium and one auxospore; *second*, a single frustule, self-fertilized, producing two sporangia and two auxospores; *third*, two conjugating frustules, with undifferentiated endochrome, producing one sporangium and one auxospore; *fourth*, two conjugating frustules, with differentiated endochrome, producing two sporangial cells, one of which is sometimes abortive. Good examples of conjugation may be found in *Surirella splendida*, *Epithemia turgida*, and in various species of *Melosira*. The sporangial frustules of *Melosira* (shown in Pl. III, Fig. 17) are quite common.

**Classification of Diatoms.**—Several methods of classification of diatoms have been proposed, but only two are worthy of attention, and even these must be considered as provisional.

The most recent is that proposed by Pfitzer and elaborated by Petit. It is based upon two assumptions—namely, that

the internal disposition of the endochrome is constant for all individuals of the same species, and that the relation between the frustule and the endochrome is fixed and common to all species of the same genus. The family Diatomaceæ is divided into two sub-families, the Placochromaticeæ and the Coccochromaticeæ. The genera of the first sub-family have the endochrome arranged in plates or layers, and those of the second sub-family, in lumps or small granular masses. Secondary classification into tribes, etc., depends upon the symmetry of the valves with reference to the axes, the dissimilarity of the valves of a single frustule, the presence or absence of an intervalvular diaphragm, the raphé, nodules, etc. There is little to be said in favor of this system, but it is worthy of study as the authors have tried to do what has been long neglected—namely, to emphasize the study of the entire cell with its contents rather than to confine the attention wholly to the cell-wall or frustule.

The most useful system of classification and the one generally recognized is that suggested by H. L. Smith. It is based almost entirely on the morphology of the frustule. This has the advantage of enabling one to classify both living and fossil forms, but it has tended to divert observers from the study of the diatom as a living cell to the study of the shell alone.

According to Smith's classification the Diatomaceæ are divided into three tribes characterized by the presence or absence of a raphé. An outline of this classification, together with descriptions of the genera most common in drinking water, is given below. The names of the genera are printed in heavy type.

#### TRIBE I. RAPHIDIEÆ

Always possessing a distinct raphé on one or both valves. Central nodule generally present and conspicuous. Frustules mostly bacillar in valve view; sometimes broadly oval; without spines or other processes. *Navicula major* is the typical form.

**FAMILY CYMBELLEÆ.**—Raphé mostly curved. Valves alike, more or less arcuate, cymbiform.

**Amphora.**

Frustules single, ovoidal in girdle view, the girdle often striated or longitudinally punctate. Valves extremely unsymmetrical, with a convex and concave side, with an eccentric raphé, with medial and terminal nodules. The raphé is sometimes near the convex side, sometimes near the concave side, and the medial nodule is often away from the center. There are transverse striæ, radiating somewhat from the medial nodule. This genus is very ornate. There are a number of species, none of them very common in water. (Pl. I, Figs. 1 and 2.)

**Cymbella.**

Frustules generally single, elongated, symmetrical with respect to the minor axis. Valves more or less arched, with one side very convex and the other side slightly or not at all convex; asymmetrically divided by a curved raphé; possessing terminal and medial nodules; marked by transverse bead-like striæ, which do not extend to the raphé, but have a clear space, wider at the medial nodule than elsewhere. There are a number of common species. (Pl. I, Figs. 3 and 4.)

**Encyonema.**

Frustules, when young, enclosed in a hyaline mucilaginous tube, in which they multiply by division, pushing each other forward in an alternately inverse position. Valves symmetrical with respect to the minor axis, convex on one side, straight on the other, with rounded extremities that project beyond the straight side. A straight raphé divides the valves into two unequal parts. There are medial and terminal nodules. The striæ are transverse or radiating somewhat from the medial nodule. There is a clear space around the medial nodule, but elsewhere the striæ approach closely to the raphé. There are several species. (Pl. I, Fig. 5.)

**Cocconema.**

Frustules, when young, borne singly or in pairs on filamentous pedicels, which may be simple or branched. They form mucilaginous layers on submerged objects. Later they become free-swimming. The valves are long, large, strongly arched, convex on one side, concave on the other side save for a little inflation in the middle. The raphé is curved. There are medial and terminal nodules. The striæ are rather large pearls, transverse, with very slight radiation, and not approaching the raphé closely. (Pl. I, Fig. 6.)

**FAMILY NAVICULÆÆ.**—Valves symmetrically divided by the raphé. Frustules not cuneate or cymbiform.

**Navicula.**

Frustules, single, symmetrical with respect to both axes. Valves naviculoid, or boat-shaped; of various proportions, some very long and narrow, others short and wide, others ellipsoidal; with straight or slightly curving sides; with ends pointed or rounded. There is a straight raphé with conspicuous medial and terminal nodules. The valves are marked with transverse furrows, that have a slight radial tendency. The frustules are rectangular in girdle view and show the nodules plainly. There is a vast number of species and varieties, many of which are very common. In some species the striæ can be resolved into pearls. These are the Naviculæ proper. In other species they cannot be resolved, and the valves usually have wide rounded ends. These were formerly set apart as a separate genus—Pinnularia. (Pl. I, Figs. 7 and 8.)

**Stauroneis.**

Frustules similar to those of Navicula. Valves symmetrical, possessing a straight raphé, with medial and terminal nodules. The striæ are pearled. There is a narrow clear space along the raphé and a wider transverse clear space at the medial nodule extending to the sides of the valve, so that the valves have the appearance of being marked with a cross. A number of species have been described, but in some instances they are very similar to Navicula. (Pl. I, Figs. 9 and 10.)

**Schizonema.**

Frustules quite similar to those of Navicula, and enclosed in mucilaginous tubes, as Encyonema. Raphé straight, sometimes showing a double line. Striæ generally parallel, reaching to the raphé, but not to the central nodule, around which there is a clear space. More common in salt water than in fresh water.

**Pleurosigma.**

Frustules like those of Navicula, but with axis turned like a letter S. Raphé sigmoidal. Striæ ornate, pearled, very fine on some species. Endochrome in two layers. (Pl. I, Fig. 11.)

**FAMILY GOMPHONEMÆÆ.**—Valves cuneate; central nodule unequally distant from the ends.

**Gomphonema.**

Frustules borne on pedicels more or less branched. Valves wedge-shaped, with more or less undulating margins and rounded ends. A central nodule near the large end. Raphé straight, dividing the

valve symmetrically. Striæ pearly, transverse, radiating slightly about the nodules. The frustules seen in girdle view are wedge-shaped, with straight sides and with central nodule visible. There are a number of species, some of which are common. (Pl. I, Fig. 12.)

FAMILY COCCONIDEÆ.—Frustules with valves unlike. Valves broadly oval.

#### Cocconeis.

Frustules somewhat arched or lens-shaped; in valve view, elliptical or discoidal. Striæ have a general direction transverse to the axis, but the convexity of the frustules gives them the appearance of inclining toward the poles. Upper and lower valves dissimilar, possessing a medial nodule and raphé or pseudo-raphé. (Pl. I, Figs. 13 and 14.)

### TRIBE II. PSEUDO-RAPHIDIEÆ

Possessing a false raphé (simple line or blank space) on one or both valves; with or without nodules. Frustules generally bacillar, sometimes oval or suborbicular, without processes, spines, or awns. *Synedra Gaillonii* is the typical form.

FAMILY FRAGILARIEÆ.—Frustules adherent, forming a ribbon-like, fan-like, or zigzag filament, or attached by a gelatinous cushion or stipe.

#### Epithemia.

Frustules cymbiform, symmetrical with respect to the minor axis, with a false raphé and no nodules. Valves marked by lines and pearls approximately at right angles to the major axis, but inclined toward the end of the frustule on the convex side. The frustules in girdle view are seen to be somewhat inflated at the center. There are several species, differing considerably in the shape of the valves. (Pl. I, Figs. 15 and 16.)

#### Eunotia.

Frustules elongated, symmetrical with respect to the minor axis. Occurring singly, free-swimming or attached. Valves arcuate, with the convex side undulated. Transversely striated, with two false terminal nodules and no medial line. The frustules are quadrangular in girdle view. There are but few species, the most common being the *E. tridentula*. (Pl. I, Fig. 17.)

**Himantidium.**

Sometimes included under Eunotia. The frustules differ from Eunotia by remaining attached after division, forming a band as in *Fragilaria*; by having the convex side of the valve entire instead of undulate; and by being somewhat bent in girdle view. (Pl. II, Figs. 1 and 2.)

**Asterionella.**

Frustules long, linear, inflated at the ends. They are united by their extremities into stabs or chains, as shown in the girdle view. The typical group is composed of 8 frustules symmetrically and radially arranged. Groups of 4, 6, or 7 are common. When rapidly dividing they may assume a spiral arrangement. The valves are very finely striated, with a straight pseudo-raphé. There is one general species, the *A. formosa*, characterized by having the basal end of the frustules much larger than the free end, and by having on that end a larger surface in contact with the adjoining frustules. There are several varieties, advanced by some authors to the rank of species. The most common is *A. formosa*, var. *gracillima*. (Pl. II, Figs. 3 to 7.)

**Synedra.**

Frustules elongated, straight or slightly curved. Valves somewhat dilated at the center and with a medial line or false raphé and occasionally false nodules. They usually have straight and almost, but not quite, parallel-sides. They are finely transversely striated. There are several common species. *S. pulchella* has lanceolate valves, with ends somewhat attenuated. In girdle view they are seen to be attached valve to valve and present the appearance of a long band or a fine-toothed comb. *S. ulna* has a very long rectilinear valve, with conspicuous transverse striæ. There is a false raphé with a narrow clear space. They are often free-floating. *S. lanceolata* has a long thin valve, swollen at the center, but tapering to sharp points at the ends. *S. radians* has straight needle-like valves. They are united at the base like *Asterionella*, but the frustules do not lie in the same plane. (Pl. II, Figs. 8 to 11.)

**Fragilaria.**

Frustules attached side by side, forming bands as in the case of *Synedra pulchella*. Valves elongated, straight, with ends lanceolate or slightly rounded. In girdle view the frustules are rectangular and are in contact with each other through their entire length. Valves transversely striated, with a false raphé scarcely visible. There are several common species. (Pl. II, Figs. 12 and 13.)

**Diatoma.**

Frustules attached by their angles forming zigzag chains, or rarely in bands. In girdle view they are quadrangular. Valves elliptical-lanceolate, with transverse ribs, between which are fine striæ. There is a longitudinal pseudo-raphé. There are two common species—*D. vulgare* and *D. tenue*. (Pl. III, Figs. 1 to 3.)

**Meridion.**

Frustules attached valve to valve, forming curved bands seen as fans, circles, or spiral bands. The frustules are wedge-shaped in girdle view, which causes the peculiar shape of the bands. Valves also wedge-shaped, with somewhat rounded ends; furnished with transverse ribs, between which are fine striæ. Pseudo-raphé indistinct. There is one principal species—*M. circulare*. (Pl. III, Figs. 4 and 5.)

FAMILY TABELLARIÆ.—Frustules with internal plates, or imperfect septa, often forming a filament.

**Tabellaria.**

Frustules square or rectangular in girdle view, attached by their corners and forming zigzag chains. In this view they are seen to be marked with longitudinal dividing plates, which extend from the ends not quite to the middle and which terminate in rounded points. The valves are long and thin, and are dilated at the extremities and in the middle. There are fine transverse striæ and an indistinct pseudo-raphé. The endochrome is usually in rounded lumps. There are two very common species—*T. fenestrata* and *T. flocculosa*. (Pl. III, Figs. 6 to 9.)

FAMILY SURIRELLÆ.—Frustules alate or carinate; frequently cuneate.

**Nitzschia.**

Frustules free, single, elongated, linear, slightly arched, or sigmoidal; with a longitudinal keel and one or more rows of longitudinal points. Valves finely striated, without nodules. There are many species. (Pl. III, Figs. 10 to 12.)

**Surirella.**

Frustules free, single, furnished with alæ on each side. A transverse section of the frustule shows a double-concave outline. Valves oval or elliptical, with conspicuous transverse tubular striæ, or canaliculi, between which there are sometimes very fine pearly striæ. There is a wide clear space, or pseudo-raphé. The frustules are sometimes cuneate in girdle view. The valves sometimes have a warped surface. There are many common species, most of them of very large size. (Pl. III, Figs. 13 and 14.)

## TRIBE III. CRYPTO-RAPHIDIEÆ

Never possessing a raphé or a false raphé. Frustules generally circular or angular, often provided with teeth, spines, or processes. *Stephanodiscus* Niagara is the typical form.

FAMILY MELOSIREÆ.—Frustules cylindrical, adhering and forming a stout filament; valves circular, sometimes armed with spines.

**Melosira.**

Frustules with circular valves and very wide connective bands, attached valve to valve so as to form long cylindrical filaments. In girdle view they are usually rectangular, though sometimes with rounded ends; at the center there are often conspicuous constrictions. The girdles are often marked with dots. The valves are radially striated, with a clear central space. At the edge there is often a keel or row of projecting points, seen in girdle view. There are several common species. *M. granulata* is the most common free-floating form, and *M. varians*, the most common filamentous form. (Pl. III, Figs. 15 to 17.)

FAMILY COSCINODISCEÆ.—Valves circular, generally with radiating cellules, granules, or puncta; sometimes with marginal or intramarginal spines or distinct ribs; without distinct processes.

**Cyclotella.**

Frustules discoidal, single, occasionally attached valve to valve, but never forming long filaments. Valves circular, finely marked by radial striæ. There is usually an outer ring of radial lines, inside of which there are puncta and fine dots somewhat irregularly arranged. These cannot be seen with low powers. In girdle view the frustules appear rectangular or somewhat sigmoidal, with warped valves, as in *C. operculata*. They are often of very small size. (Pl. III, Figs. 18 and 19.)

**Stephanodiscus.**

Frustules discoidal, single. Valves circular, with curved surface, with fringe of minute marginal teeth. Striæ fine radial. Frustules rectangular in girdle view, showing projection of middle of valve. Teeth most conspicuous in girdle view. Endochrome conspicuous, in rounded lumps. The frustules are often of considerable size. (Pl. III, Figs. 20 and 21.)

## REFERENCES

- APSTEIN, C. 1896. Das Süßwasserplankton. Kiel u. Leipzig, Lipsius & Tischer.
- ATTWOOD. Diatoms from the Chicago Water Supply. *Mo. Micro. Jour.*, XVII, 266. London.
- BRONNS KLASSEN U. seit 1859. Ordnungen des Tierreiches (Protozoen, einige Gruppen der Metazoen). Leipzig, C. F. Winter.
- CASTRACANE, CONT ABBÉ F. 1889. *Reproduction and Multiplication of Diatoms.* *J. R. M. S.*, 22. London, 1889.
- DEBY, JULIEN. 1882. *A Bibliography of the Diatomaceæ. "A Bibliography of the Microscope,"* III. London. Also, *Bibliographie Diatomologique.* *Jour. Microg.*, XI, 217. Paris, 1887.
- HASSALL, ARTHUR H. 1856. *The Diatomaceæ in the Water Supplied to the Inhabitants of London: Microscopic Examination of the Water.* London.
- KIRCHNER, O. 1891. *Die mikroskopische Pflanzenwelt d. Süßwassers.* 2. Aufl. Hamburg, L. Graefe & Sillem.
- KLINKHARDT, W. seit 1908. *Revue, Internationale, der gesamten Hydrobiologie und Hydrographie,* Leipzig.
- KUETZING, F. 1844. *Die Bacillarien, oder Diatomeen.* Nordhausen.
- MILLS, FREDK. WM. 1893. *An Introduction to the Study of the Diatomaceæ.* London; also, *The Microscopical Pub. Co., Washington, D. C.* Contains an extensive bibliography on the Diatomaceæ by Julien Deby.
- MIQUEL, P. *De la culture artificielle des Diatomées.* *Le Diat.*, I, 73, 93, 121, 123, 149, 165. Paris.
- PELLETAN, J. 1891. *Les Diatomées.* Paris.
- SCHMIDT, ADOLF. 1875. *Atlas der Diatomaceen-Kunde.* In Verbindung mit den Herren Grundler, Grunow, Janisch, Weissflog und Witt. (There is a blue-print reproduction of these plates by C. Henry Kain, Camden, N. J.)
- SCHÜTT, F. 1892. *Analytische Planktonstudien.* Kiel u. Leipzig, Lipsius & Tischer.
- SCHURIG, W. 1909. *Plankton-Praktikum.* Leipzig. Quelle & Meyer.
- SMITH, H. L. 1872. *Conspectus of the Families and the Genera of the Diatomaceæ* *Lens*, I, 1, 72, 154. Chicago. Notice in *Amer. Naturalist*, VI, 318. Salem, 1872.
- SMITH, WM. 1853-56. *Synopsis of the British Diatomaceæ.* 2 vols. London.
- VAN HEURCK, H. 1885. *Synopses des Diatomées de Belgique.* Anvers.
- WHIPPLE, G. C., and JACKSON, D. D. 1899. *Asterionella.* *Journal of the New England Water Works Assn.* Vol. XIV.
- WISSENSCHAFTLICHE MEERESUNTERSUCHUNGEN. seit 1873. Herausgegeben v. d. Kommission z. Unters. d. deutsch. Meere in Kiel und der Biolog. Anstalt auf Helgoland. Kiel, Schmidt u. Klannig (Früher ünter anderem Titel).
- WOLLE, FRANCIS. 1890. *Diatomaceæ of North America.* Bethlehem, Pa.

(See also page 393.)

## CHAPTER XXI

### SCHIZOMYCETES

THE Schizophyceæ comprise those vegetable organisms in which the chief mode of propagation is that of cell-division. They are either destitute of chlorophyll or contain besides the chlorophyll a coloring substance known as phycocyan or phycochrome, which itself may be a modification of chlorophyll. The cells have a somewhat firm cell-wall, but no nucleus.

The Schizophyceæ may be divided into two classes—the Schizomycetes and the Cyanophyceæ. The latter contain chlorophyll, but the former do not.

Besides the bacteria, which are not described in this work, there are few genera belonging to the Schizomycetes that are of interest to the water-analyst. They are so imperfectly understood that no satisfactory classification has been suggested. Some authorities include them among the Fungi.

#### **Leptothrix.**

Simple filaments, with indistinct or no articulation, without oscillating movement, and with no sulphur-granules. There are several indistinct species. They are usually colorless. The aquatic forms occur as interwoven masses of long slender filaments, the diameter of which varies from 1 to 3  $\mu$ . The organism often called *Leptothrix ochracea*, observed in driven wells where the water contains much iron, is now known as *Chlamydothrix ochracea*. Very slender forms of *Oscillaria* are liable to be mistaken for *Leptothrix*. (Pl. IV, Fig. 1.)

#### **Cladothrix.**

Fine filaments resembling those of *Leptothrix*, colorless, usually indistinctly articulated, straight, undulated, or twisted. There are several stages of development, giving rise to cocci-, vibrio-,

spirochætæ-, and filamentous-forms. The special characteristic of the genus is that of false branching, a turning aside of single portions of the filaments followed by subsequent terminal growth. There are several indistinct species. The most important is *C. dichotoma*, which is found in sewage and polluted water. (Pl. IV, Fig. 2.)

#### **Beggiatoa.**

Threads indistinctly articulated, colorless, containing numerous dark sulphur granules. The filaments often have an active oscillating movement. They are usually short and from 1 to 3  $\mu$  in diameter. Sometimes abundant in sulphur springs. There are several doubtful species. The most common is *B. alba*. (Pl. IV, Fig. 3.)

### THE IRON BACTERIA

Of the organisms which deposit iron *Crenothrix* is the most conspicuous example and the one which is most often mentioned by American writers. The name *Crenothrix* has as a matter of fact been applied to several genera which are recognized as distinct. The following description has been commonly given of *Crenothrix*.

#### **Crenothrix.**

Filaments unbranched, cylindrical, transversely divided into cells, surrounded by a gelatinous sheath which becomes yellow or yellowish-brown through deposits of iron or manganese. Multiplication takes place by transverse fission and occasionally by longitudinal fission. Cells also escape from the sheath at the end or side and, by division, form new filaments. Reproduction occurs through spores formed from the cells within the sheath. It occurs in single filaments or in brownish tufts or mats, often of considerable thickness. The filaments are  $1\frac{1}{2}$  to 4  $\mu$  thick, and the sheath is several times the thickness of the filaments. Articulation is distinct. When the iron of the sheath is dissolved by dilute hydrochloric acid the cells appear in side view as distinct rectangles, each one somewhat removed from its neighbor. This appearance is characteristic of *Crenothrix*. During growth the cells sometimes push themselves forward in the sheath, leaving the empty sheath behind. The older portion of the sheath is darker colored than the growing points. *Crenothrix* occurs chiefly in ground-waters rich in organic matter, iron salts and carbonic acid and deficient in oxygen. Its growth is favored by darkness. (Pl. IV, Fig. 4.)

Jackson has proposed a new classification of this genus, based on the character of the sheath-deposit. *C. Kühniana*, which deposits iron, he maintains; *Leptothrix ochracea*, which deposits alumina, he renames *C. ochracea*; and a new species, which deposits manganese, he calls *C. manganifera*.

#### Other Iron Bacteria.

The other iron bacteria differ from *Crenothrix* chiefly in the following characteristics:

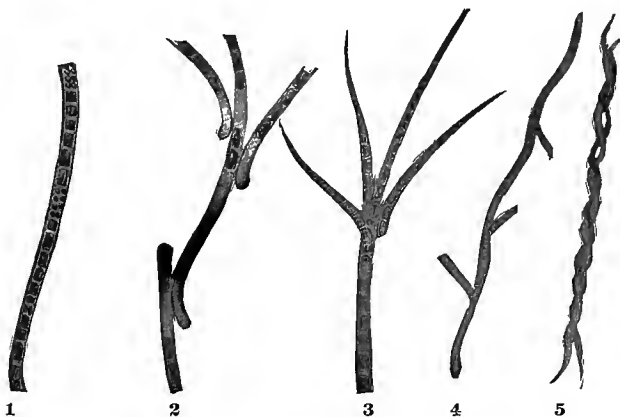

FIG. 73.

#### IRON BACTERIA

- |                        |                           |
|------------------------|---------------------------|
| 1. <i>Crenothrix</i> . | 3. <i>Clonothrix</i> .    |
| 2. <i>Cladothrix</i> . | 4. <i>Chlamydothrix</i> . |
|                        | 5. <i>Gallionella</i> .   |

*Chlamydothrix* has a brownish sheath and is branched. The older filaments are deeply colored with the oxides of iron or manganese.

*Gallionella* has its filaments twisted into a helix. Often two filaments are twisted together.

*Cladothrix* has the characteristic false branching.

*Clonothrix* has branched filaments, the ends of the branches being pointed.

These different genera are shown in Fig. 73.

More complete descriptions may be found in "Die Eisenbakterien" by Dr. Hans Molisch.

The stems of *Anthrophyta*, an organism very common in swampy waters are often mistaken for organisms of this group.

## REFERENCES

- COHN, F. 1870. Ueber den Brunnenfaden, mit Bemerkungen über die mikroskopische Analyse des Brunnenwassers. Beiträge zur Biologie, I, 117-131.
- COOKE, M. C. 1886. Rust, Smut, Mildew, and Mould: An Introduction to the Study of the Microscopic Fungi. 5th edition. London: W. H. Allen & Co.
- DE BARY, A. 1887. Comparative Morphology and Biology of the Fungi, Mycetozoa, and Bacteria. Oxford: Clarendon Press.
- DE VRIES, HUGO. 1890. Die Pflanzen und Thiere in den dunkeln Räumender. Rottdamer Wasserleitung. Jena.
- GARRETT, J. H. 1896-97. *Crenothrix polyspora*, var. *Cheltonensis*. A history of the reddening and contamination of a water-supply and of the organism which caused it, with general remarks upon the coloration and pollution of water by other algæ. Public Health, IX, 15-21. London.
- GIARD, A. 1882. Sur le *Crenothrix Kuhniana*; la cause de l'infection des eaux de Lille. Compt. rendu Acad. d. Sc., XCV, 247-249. Paris.
- MOLISCH, DR. HANS. 1910. Die Eisenbakterien. Jena: Gustav Fischer.
- JACKSON, DANIEL D. 1901. A New Species of *Crenothrix*. Transactions of the Amer. Micros. Soc. August, 1901.
- ZOPF, DR. WILHELM. 1890. Die Pilze. Breslau.

(See also page 393.)

## CHAPTER XXII

### CYANOPHYCEÆ

THE plants belonging to the Cyanophyceæ, or Myxophyceæ, are characterized by the presence of chlorophyll plus certain coloring substances known as cyanophyll, phycocyanine, phycoxanthine, etc., which are probably modifications of chlorophyll; by the absence of a nucleus and usually of starch-grains; and by extremely simple but imperfectly understood methods of reproduction. The plants are one- or many-celled. By successive division of the cells they are very commonly associated in families that take the form of filaments or of spherical or irregular masses.

The cell-wall is often distinct and sharply defined, but in some cases it is fused with a gelatinous mass in which the cells are embedded. This gelatinous matrix is more common in the terrestrial than in the aquatic species. The cell-contents are usually granular and homogeneous.

The color varies considerably in different species and under different conditions. It is never a chlorophyll green, but ranges from a color approaching that to a blue-green, orange-yellow, brown, red, or violet. The coloring matter known as phycocyanine has a bluish color when viewed by transmitted light, and a reddish color when viewed by reflected light. This phenomenon is often observed in ponds where Cyanophyceæ are abundant. Looking directly at the pond the water may have a reddish-brown color, while a bottle filled with the water and held to the light may present a decidedly bluish-green appearance. This is particularly true when the plants have begun to decay. The phycoxanthine is said to have a yellowish color. The liberation of the gas bubbles from some species

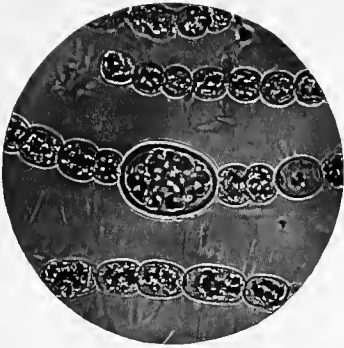

Anabaena.



Rivularia.



Aphanizomenon.



Coelosphaerium.

PLATE C.

Photomicrographs of Microscopic Organisms.

seems to have an effect on the color of the organisms. *Anabæna*, for example, may have a brownish-green color in a reservoir and a very light blue-green color after it has passed through the pipes of a distribution system, where the pressure has caused the gas to be expelled.

The Cyanophyceæ are usually separated into five or six groups, which are ranked by different writers as *orders*, *families*, or *sections*. The groups are here considered as families belonging to two orders.

### ORDER I. CYSTIPHORÆ

Unicellular plants with spherical, oblong, or cylindrical cells enclosed in a tegument and associated in families, are surrounded by a universal tegument or immersed in a generally colorless, mucilaginous substance of varying consistency. Division takes place in one, two, or three directions, the cells after division usually remaining together forming an amorphous thallus. It is probable that most of the forms belonging to this order are but intermediate stages in the life-history of plants higher in the scale of life. There is but one family. It contains about a dozen rather imperfectly defined genera.

**FAMILY CHROÛCOCCACEÆ.**—Thallus mucous or gelatinous, amorphous, enclosing cells and families irregularly disposed.

#### **Chroöcoccus.**

Cells spherical, or more or less angular from compression, solitary or united in small families. Cell-membrane thin or confluent in a more or less firm jelly. Cell-contents pale bluish-green, rarely yellowish. Propagation by division in three directions. Several species are described. Most of them are terrestrial and not aquatic. The most common aquatic species are *C. turgidus*, the cells of which are from 10 to 25  $\mu$  in diameter, and *C. cohærens*, the cells of which are from 3 to 6  $\mu$  in diameter. (Pl. IV, Fig. 5.)

#### **Glœocapsa.**

Cells spherical, single or in groups; each cell surrounded by a vesiculiform tegument and groups of cells surrounded by an additional tegument. Cell-membrane thick, lamellated, and sometimes colored. Division in three directions. Cell-contents bluish-green, brownish,

or reddish. There are many described species, based on slight distinctions and variations in size and color. *Glœocapsa* found in water usually has smaller cells and a more distinct tegument than *Chroococcus*. Comparatively few species are aquatic. (Pl. IV, Fig. 6.)

#### **Aphanocapsa.**

Cells spherical, with a thick, soft, colorless tegument, confluent in a homogeneous mucous stratum which is sometimes of a brownish color. Cell-contents bluish-green, brownish, etc. The cells divide alternately in three directions. There are several species. The cells vary in size from 3 to 6  $\mu$ . (Pl. IV, Fig. 7.)

#### **Microcystis.**

Cells spherical, numerous, densely aggregated, enclosed in a very thin, globose mother-vesicle, forming solid families, singly or several surrounded by a universal tegument. Cell-contents æruginous to yellowish-brown. The cells divide alternately in three directions. This genus represents a condition of frequent occurrence in the process of development of higher forms. There are several indistinct species common in water. The cells vary in size from 4 to 7  $\mu$  in diameter and the colonies from 10 to 100  $\mu$ . (Pl. IV, Fig. 8.)

#### **Clathrocystis.**

Cells very numerous, small, spherical or oval, æruginous, embedded in a colorless matrix. Multiplication by division of the cells within the thallus. The thallus is at first solid, then becomes saccate and clathrate (perforated); broken fragments are irregularly lobed. There is but one species—*C. æruginosa*. The cells are from 2 to 4  $\mu$  in diameter and the thallus from 25  $\mu$  to 5 mm. This species is widely distributed. (Pl. IV, Fig. 9.)

#### **Cœlosphærium.**

Cells numerous, minute, globose or subglobose, geminate, quaternate, or scattered, immersed in a mucous stratum. Cell-contents æruginous, granulose. The thallus is globose, vesicular, hollow, the cells being found only on the outer surface. Multiplication takes place by division of the cells on the surface and by the escape and further development of certain peripheral cells. There is one common species, *C. Kuetzingianum*. The cells are from 2 to 5  $\mu$  in diameter and the thallus from 50 to 500  $\mu$ . (Pl. IV, Fig. 10.)

#### **Merismopedia.**

Cells globose or oblong, æruginous or brownish, with confluent teguments. Division in two directions. The thallus is tabular,

quadrate, free-swimming, the cells being arranged in groups of 4, 8, 16, 32, 64, 128, etc. There are several indistinct species. The diameter of the cells varies from 3 to 7  $\mu$ . (Pl. IV, Fig. 11.)

#### **Glœothece.**

Similar to *Glœocapsa*, but with oblong or cylindrical, instead of spherical cells. Terrestrial rather than aquatic.

#### **Aphanothece.**

Similar to *Aphanocapsa*, but with oblong instead of spherical cells.

#### **Tetrapedia.**

Cells compressed, quadrangular, equilateral, subdivided into quadrate or cuneate segments or rounded lobes, either by deep incisions or wide angular sinuses. This genus is of doubtful value.

### ORDER II. NEMATOGENÆ

Multicellular plants, the cells of which dividing in one direction, form filaments, often enclosed in a tubular sheath. The filaments (trichomes) may be either simple or branched. There are five families.

**FAMILY NOSTOCACEÆ.**—Plants composed of rounded cells loosely united into filaments, or trichomes, and sometimes embedded in jelly. The filaments do not branch and never terminate in a hairpoint. They sometimes form large masses. There are three kinds of cells—ordinary vegetative cells, joints, or articles; heterocysts; and spores. The ordinary cells are spherical, elongated, or compressed. The cell-contents are bluish-green or brownish, and are usually granular. The heterocysts are cells found at intervals in the filaments. They are spherical, elliptical, or elongated, and are usually somewhat larger than the vegetative cells. Their cell-contents are generally clear or very finely granular, and usually of a light bluish-green color. The cell-wall is sharply defined, and there are two polar lumps of gelatinous material that cause them to adhere to the adjoining cells. The function of the heterocysts is unknown, but they are thought to be in some way connected with the process of reproduction. The spores are usually much larger than the vegetative cells. They are spherical, elliptical, or cylindrical. Their cell-contents are usually very granular and dark-colored. They seem to be more highly differentiated than the contents of the vegetative cells. The spores are heavy, and will sink in water when freed from the filaments. Multiplication takes place

by division of the vegetative cells, by means of the spores, and by means of hormogons, or parts of the internal trichomes which separate from the filaments and form new plants. The character and position of the heterocysts and spores form the chief basis for the division of the Nostocaceæ into genera. The classification is very indefinite.

#### **Nostoc.**

Cells globose or elliptical; heterocysts usually globose and somewhat larger than the vegetative cells; spores oval and but little larger than the heterocysts. Spores and heterocysts are both intercalated in the filaments, rarely terminal. The filaments are enclosed in a gelatinous envelope, and are flexuously curved and irregularly interwoven. They often form gelatinous fronds or thalli surrounded by a firm membrane. The thalli vary in diameter and are sometimes of great size. There are many species, both terrestrial and semi-aquatic. The species are not well defined, and many of them are intermediate stages in the life-history of higher forms. The true Nostoc is seldom found in drinking water. (Pl. IV, Fig. 12.)

#### **Anabæna.**

Vegetative cells spherical, elliptical, or compressed in a quadrate form. Heterocysts much larger than the vegetative cells, subspherical, elliptical, or barrel-shaped, of a pale yellowish-green color, and intercalated in the filament. Spores globose or oblong-cylindrical, equal to or somewhat larger than the heterocysts, rarely smaller, never adjacent to the heterocyst. The filaments are moniliform; are without sheaths; are straight, curved, circinate, or intertwined; have a bluish-green or brownish color; and are often free-floating. There are several important but imperfectly defined species. The most common species are *A. flos-aquæ* and *A. circinalis*. The vegetative cells of the former are from 5 to 7  $\mu$  in diameter; those of the latter are from 8 to 12  $\mu$ . (Pl. IV, Figs. 13 and 14.)

#### **Sphærozyga.**

Vegetative cells spherical, elliptical, or transversely compressed; of a bluish-green or brownish color. Heterocysts spherical or oval, intercalated, binary or solitary, only slightly larger than the vegetative cells. Spores on each side of and adjacent to the heterocysts, cylindrical, with rounded ends, considerably larger than the heterocysts. The filaments are moniliform; are sheathless or covered with a mucilaginous coating, occasionally agglutinated in a gelatinous stratum. There are several species, terrestrial and aquatic. The genus is very similar to Anabæna. (Pl. V, Fig. 1.)

**Cylindrospermum.**

Vegetative cells globose, elliptical, or compressed, homogeneous or granular. Heterocysts terminal, spherical, or oval, but little larger than the cells. Spores adjacent to the heterocysts, oval or cylindrical, much larger than the cells. The filaments are moniliform, sheathless, and sometimes taper slightly. There are few species, and these resemble some forms of *Anabæna* and *Sphærozyga*. (Pl. V, Fig. 2.)

**Aphanizomenon.**

Vegetative cells cylindrical, closely connected, granular, and with little color. Heterocysts rare, intercalated, oval, but little larger in diameter than the cells. Spores very rare, intercalated, not adjacent to heterocysts, cylindrical, with rounded ends, sometimes of dark olive color. The filaments are cylindrical, slightly tapering, and densely agglutinated in fascicles, occasionally free. The fascicles are often of considerable size. Diameter of filaments 4 to 6  $\mu$ . This genus is sometimes mistaken for *Oscillaria* or *Anabæna*. (Pl. V, Fig. 3.)

FAMILY OSCILLARIÆ (LYNGBYÆ).—Filaments without heterocysts or spores, with or without sheath, not terminating in a hair-point, single or associated in bundles enclosed in a common sheath. The division of the filaments into cylindrical cells is indistinct. Multiplication is said to take place by hormogons, i.e., parts of the trichomes which separate from the rest of the filament.

**Oscillaria.**

Cells shortly cylindrical, disk-shaped in end-view, closely united into a simple, branchless, sheathless filament. The filaments are straight or somewhat curved, occasionally fasciculate, and have rounded ends. The color is bright bluish-green, steel-blue, etc. The filaments when in active vegetative state possess characteristic spontaneous oscillating movements. There is a large number of species, that vary in diameter from 1 to 50  $\mu$ , and have cells differing in shape and in color. There are but few free-floating forms. (Pl. V, Fig. 4.)

**Lynbya.**

Filaments enclosed singly in a sheath, branchless, but with occasional appearance of branching during multiplication, sometimes combined to form a membranaceous stratum. Cells united into short trichomes, with rounded ends, not continuous in the sheath, but separated by clear spaces. Cell-contents blue-green, granular.

Sheaths pellucid, hyaline. Propagation is said to take place by hormogons and by gonidia. There are many species, terrestrial and aquatic. (Pl. V, Fig. 5.)

#### **Microcoleus.**

Filaments rigid, articulate, crowded together in bundles, enclosed in a common mucous sheath, either open or closed at the apex. Sheath ample, colorless, rarely indistinct. Several species, chiefly terrestrial. (Pl. V, Fig. 6.)

**FAMILY SCYTONEMÆ.**—Filaments with lateral ramifications (false branching) in which some of the cells change into heterocysts; enclosed in a sheath. The cells divide transversely. The ramifications are produced by the deviation of the trichome and emergence through the sheath. The branches do not have a hair-point. There are several genera.

#### **Scytonema.**

Sheath enclosing a single trichome, composed of subspherical or subcylindrical cells, with scattered heterocysts. Color bluish- or yellowish-green. Ramification takes place by a folding of the trichomes, followed by rupture of the sheath and the emergence of one or two portions of the folded trichome at right angles to the original filament. These branched filaments produce interwoven mats. Multiplication is said to take place by microgonidia. There are many species, terrestrial and aquatic. The plant is not found free-floating. (Pl. V, Fig. 7.)

**FAMILY SIROSIPHONÆ.**—Trichomes enclosed in an ample sheath, profusely branched. Branches are formed by longitudinal division of certain cells so as to form two sister cells, the inferior of which remains a part of the trichome, while the other, by repeated division, grows into a branch. The filaments often contain 3, 4, or more series of cells. Propagation is said to take place by means of microgonidia.

#### **Sirosiphon.**

Cells one-, two-, or many-seriate, in consequence of their lateral division or multiplication. The cells have a distinct membrane, and the sheaths are large. The plant is never found free-floating. (Pl. V, Fig. 8.)

**FAMILY RIVULARIÆ.**—Filaments free or agglutinated into a definite thallus, terminating at the apex in a hair-like extremity. Heterocysts usually basal. Trichomes articulated like *Oscillaria*, parallel or radially

disposed. Spores, when present, cylindrical, generally adjacent to the basal heterocyst.

**Rivularia.**

Filaments radial, agglutinated by a firm mucilage, and forming well-defined hemispherical or bladdery forms. Heterocysts basal. No spores formed. Ramifications produced by transverse division of the trichomes. Color greenish to brownish. Sheaths usually distinct. Several species, terrestrial and aquatic. Occasionally found free-floating. (Pl. V, Fig. 9.)

REFERENCES

(See pages 340 and 393.)

## CHAPTER XXIII

### CHLOROPHYCEÆ

THE plants belonging to the Chlorophyceæ are characterized by the presence of true chlorophyll, a nucleus, starch-grains, and often by a cell-wall made of cellulose. They are "algæ" in the strictest sense of the term. They cover a great range of complexity. Some of them are minute, unicellular forms scarcely distinguishable from the Cyanophyceæ; others resemble the Protozoa; while others are large, branching, multicellular forms doubtfully included among the algæ, and very similar to plants much higher in the scale of life. Most of them are aquatic, but a few are terrestrial. Their color is almost always a bright chlorophyll green, but occasionally it is yellowish-brown or even a bright red. The Chlorophyceæ increase by the ordinary processes of cell-division observed in the higher forms of plant life. The cells may separate after division, or they may remain associated in colonies or in simple or branching filaments. Reproduction takes place either asexually, i.e., without the aid of fecundation, or sexually. There is but one general method of asexual reproduction, namely, the formation within the cell of spores, which become scattered and give rise to new cells. There are three general types of sexual reproduction. The simplest is the formation in the cells of zoöspores, which become liberated and ultimately copulate with other zoöspores. Two of these zoöspores become attached by their ciliated ends, their contents become fused, and a zygospore results. After a period of rest zygospore may develop into a new plant, or may break up into other spores. The second type of sexual reproduction is known as conjugation. Two cells come in contact, and by means of openings in the cell-walls

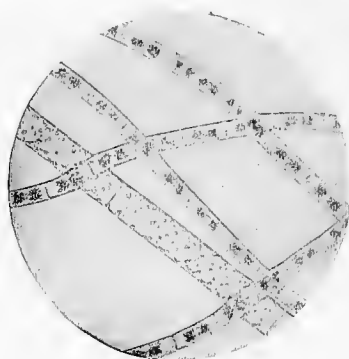

Spirogyra and Zygnema.

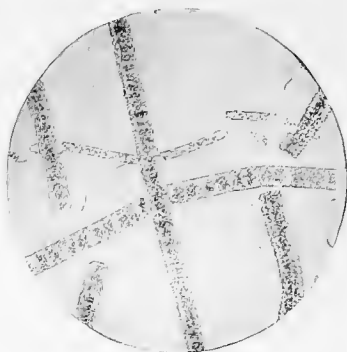

Zygnema.



Draparnaldia.



Batrachospermum.

## PLATE D.

Photomicrographs of Microscopic Organisms.

their contents become fused. A zygospore (sometimes two) is formed, which, after a period of rest, gives rise to new plants. The highest form of sexual reproduction takes place by the formation of a rather large female oospore, which becomes fertilized by small male cells or spermatozoids. This mode of reproduction is analogous to that observed in the higher plants. Many of the Chlorophyceæ exhibit the phenomenon of "alternation of generations," by which is meant the continued propagation of the plants by asexual processes with occasional intervention of the sexual processes.

### ORDER I. PROTOCOCCOIDEÆ

Unicellular plants. Cells single or associated in families; tegument involute or naked; no branching or terminal vegetation. This order includes many of the free-floating green algæ that are found in water.

FAMILY PALMELLACEÆ.—Cells solitary or in families, often embedded in a jelly and forming an amorphous stratum. Multiplication by cell-division. Reproduction asexual, by active gonidia.

#### Gloëcystis.

Cells globose or oblong, single or in globose families of 2-4-8 cells. Common and individual lamellöse gelatinous integuments. Division in alternate directions. Reproduction by zoogonidia. There are several species. The size of the cells varies from 2 to 12  $\mu$  in diameter and the colonies from 10 to 100  $\mu$ . Color green, sometimes reddish. Gelatinous tegument colorless or ochraceous. Usually fixed, sometimes free-floating. (Pl. V, Fig. 10.)

#### Palmella.

Cells globose, oval, or oblong, surrounded by a thick confluent tegument; forming an amorphous thallus. Multiplication by alternate division of the cells in all directions. An uncertain genus. Several species, usually fixed. Size of cells varies from 1 to 15  $\mu$ . Thallus often large. Color generally green. (Pl. V, Fig. 11.)

#### Tetraspora.

Cells spherical or angular, with thick teguments confluent into a homogeneous mucous; forming a sac-like thallus, sometimes of large size. The cells divide in two directions and are seen normally in groups of four. The thalli are usually fixed, but the quartettes

of cells are sometimes free-floating. Several species, all green. Cells from  $3\ \mu$  to  $12\ \mu$  in diameter. (Pl. V, Fig. 12.)

#### **Botryococcus.**

Cells generally oval, with a thin confluent tegument, densely packed, forming a botryoid, irregularly lobed thallus. One species, green, free-floating, with cells  $10\ \mu$  in diameter. (Pl. VI, Fig. 1.)

#### **Raphidium.**

Cells fusiform or cylindrical, straight or curved, pointed ends, occurring singly, in pairs, or in fascicles. Cell-membrane thin, smooth. Cell-contents green, granular, with transparent vacuole. Division of cells in one direction. There are several species, with numerous varieties. Two species, *R. polymorphum* and *R. con. volutum*, are common free-floating forms. The latter is sometimes known by the name *Selenastrum*. (Pl. VI, Fig. 2.)

#### **Dictyosphaerium.**

Cells elliptical or kidney-shaped, with thick mucous investment, more or less confluent, arranged in globose, hollow families. The cells are connected by delicate threads radiating from the center of the colony and attached to the concave side of the cells. The threads branch dichotomously. Division in all directions. Two or three species. The most important species is *D. reniforme*. Color green, and cells  $6-10 \times 10-20\ \mu$ . (Pl. VI, Fig. 3.)

#### **Nephrocytium.**

Cells oblong, kidney-shaped, with ample tegument, arranged in free-swimming colonies of 2-4-8-16 cells. Two species, Green. Cells  $5 \times 15$  to  $15 \times 45\ \mu$ . (Pl. VI, Fig. 4.)

#### **Dimorphococcus.**

Cells in groups of four on short branches, the two intermediate contiguous cells oblique, obtuse-ovate; the two lateral, opposite and separate from each other, lunate. In colonies with cells connected by threads radially arranged and unbranched. One free-floating species. Color green. Cells  $5$  to  $10\ \mu$  in diameter. (Pl. VI, Fig. 5.)

**FAMILY PROTOCOCCACEÆ.**—Cells solitary or forming more or less perfect cœnobia. Propagation by asexual zoospores or by copulation of zoogonidia. In general there is no vegetative cell-division.

#### **Protococcus.**

Cells spherical, single or in irregular clusters. Cell-membrane thin, hyaline. Cell-contents green, sometimes reddish. There is but one species, *P. viridis*, with many varieties. Diameter of

cells varies from 3 to 50  $\mu$ . They are both aquatic and aerial. Some of the aquatic forms have a gelatinous tegument and are called Chlorococcus by some writers. The distinction is a difficult one to make. (Pl. VI, Fig. 6.)

#### **Polyedrium.**

Cells single, segregate, free-swimming, compressed, 3-4-8-angled. Angles sometimes radially elongated, entire or bifid, rounded at the ends. Cell-membrane thin, even. Cell-contents green, granular, sometimes with oil globules. Propagation by gonidia. There are several species. One of the most common is *P. longispinum*. (Pl. VI, Fig. 7.)

#### **Scenedesmus.**

Cells elliptical, oblong, or cylindrical, with equal or unequal ends, often produced into a spine-like horn; usually laterally united, forming cœnobium. Cell-contents green. Propagation by segmentation of cell-contents into brood families, set free by rupture of the maternal cell-membrane. There are several common species, *S. caudatus*, with several varieties, *S. obtusus*, and *S. dimorphous*. The cells are usually 2 or 3  $\mu$  in diameter and from 8 to 25  $\mu$  long. (Pl. VI, Fig. 8.)

#### **Hydrodictyon.**

Cells oblong-cylindrical, united at the ends into a reticulated, saccate cœnobium. Cell-contents green. Propagation by macrogonidia which join themselves into a cœnobium within the mother cell, and by ciliated microgonidia which copulate and form a resting-spore. One species, *H. utriculatum*. Aquatic and attached. (Pl. VI, Fig. 9.)

#### **Ophiocytium.**

Cells cylindrical, elongated, curved, or circinate, one end and occasionally both ends attenuated. Cell-contents green. Propagation by zoogonidia. There are several species. The most common is *O. cochleare*, the cells of which are from 5 to 8  $\mu$  in diameter and of various lengths. (Pl. VI, Fig. 10.)

#### **Pediastrum.**

Cells united into a plane, discoid or stellate, free-swimming cœnobium, which is continuous, or with the cells interrupted in a perforate or clathrate manner. The central cells are polygonal and entire; those of the periphery entire, bi-lobed, with lobes sometimes pointed. Cell-contents green, granular. Propagation by macrogonidia formed within the cells, which after their escape divide, arrange themselves in a single layer, and reproduce the form

of the mother plant. There are several species. The most common are *P. Boryanum* and *P. simplex*. (Pl. VI, Fig. 11.)

#### **Sorastrum.**

Cells wedge-shaped, compressed, sinuate, emarginate, or bifid at the apex; radially disposed, forming a globose, solid, free-swimming cœnobium. There is but one species, *S. spinulosum*. The cells are spined. They vary in size from 12 to 20  $\mu$ . The cœnobia vary in diameter from 25 to 75  $\mu$ . (Pl. VI, Fig. 12.)

#### **Cœlastrum.**

Cells globose, or polygonal from pressure, forming a globose, hollow cœnobium, reticulately pierced. The cells are arranged in a single layer, sometimes joined by radial gelatinous cords. Cell-contents green. Propagation by macrospores. There are several species. The most common is *C. microsporum*, which has 8-16-32 cells, and the diameter of which varies from 40 to 100  $\mu$ . (Pl. VII, Fig. 1.)

#### **Staurogenia.**

Cells oblong-oval, subquadrate, or rhomboidal, arranged in groups of 4-8-16, forming a cubical cœnobium, hollow within. Cell-contents green. Propagation by quiescent gonidia. (Pl. VII, Fig. 2.)

### **ORDER II. VOLVOCINIEÆ**

Unicellular plants occurring as mobile, globose, sub-globose, or flattened quadrangular cœnobia composed of bi-ciliated green cells which are more or less spherical or compressed. The cœnobia as a whole are motile because of the ciliated cells, and hence are free-floating. The cœnobium sometimes has an ample hyaline tegument. Cell-contents green. Propagation sexual or asexual. Asexual propagation takes place by subdivision of the larger vegetative cells into new families, which separate from the mother cell when sufficiently developed. Sexual propagation takes place by means of female spore cells, or oospores, developed from the vegetative cells, which are fertilized by antheridia developed from other vegetative cells. The antheridia, after escaping from the cell in which they are formed, perforate the membrane of the oogonia, after which the oospore goes into a resting state to

germinate later. This order is frequently referred by zoologists to the Protozoa.

FAMILY VOLVOACEÆ.—Characteristics the same as for the order.

#### Volvox.

Large cœnobium, continually rotating and moving, looking like a hollow globe composed of very numerous cells (several thousand) arranged on the periphery at regular distances, connected by a matrical gelatin which has the appearance of a membrane in which the cells are embedded. Cells globose, bearing two cilia that extend beyond the gelatinous envelope. By the waving of these cilia the colony is kept in motion. Cell-contents green; starch-granules and often a red pigment-spot present. With a high power the cells are seen to be connected to each other in a hexagonal manner by fine threads. Propagation sexual and asexual, as described under the order. The oospores and antheridia are enclosed in flask-like cells extending inward. The spermatozoids are spindle-shaped and furnished with two cilia. The resting-spores usually produce eight zoogonidia. Asexual propagation takes place by division of the larger and darker flask-like cells. These, usually eight in number, develop young volvoces in the mother cells. They are very conspicuous. The mother cell splits along well-defined lines and the young forms are set free. There is practically but one species, *V. globator*. The cœnobia are often one millimeter in diameter. (Pl. VII, Fig. 3.)

#### Eudorina.

Cœnobium oval or spherical, involved in a gelatinous mucilaginous tegument, composed of 16-32 cells arranged around the colorless sphere at equal distances. The cœnobium is often seen moving with a rolling motion. Cells globose, with two protruding cilia. Cell-contents green, sometimes with a red pigment-spot. Asexual propagation takes place by the division of the cells into 16-32 parts, each of which produces a new cœnobium. Sexual propagation as described for the order. Usually four of the thirty-two cells produce antheridia, the others oogonia. The spermatozoids are pear-shaped and are bi-ciliated. There are but two species, *E. elegans*, and *E. stagnale*. The cells vary from 5 to 25  $\mu$ , and the cœnobia from 25 to 150  $\mu$ , in diameter. (Pl. VII, Fig. 4.)

#### Pandorina.

Cœnobium globose, invested by a broad, colorless, gelatinous tegument, composed of 8 to 64 cells crowded together or aggregated in a botryoidal manner. (In this respect it differs from Eudorina.) Cells green, globose or polygonal from compression, bi-ciliated,

occasionally with a red pigment-spot. Sexual propagation takes place by the conjugation of zoospores produced in the cells of the cœnobium, which after union give rise to resting-spores. Asexual propagation takes place by cell-division. There is but one species, *P. morum*. The cœnobium is about 200  $\mu$  in diameter and the cells from 10 to 15  $\mu$ . (Pl. VII, Fig. 5.)

#### Gonium.

Cœnobium quadrangular, tabular, with rounded angles, formed from a single flat stratum of cells, girt by a broad, hyaline, plane-convex tegument. Cells 16 (4 central and 12 peripheral), polygonal, connected by produced angles, and furnished with two cilia. Cell-contents green. Asexual propagation by division. Sexual propagation unknown. There is but one species, *G. petrocale*. The genus is an uncertain one. (Pl. VII. Fig. 6.)

### ORDER III. CONJUGATA

Unicellular or multicellular plants. The multicellular forms have no terminal vegetation and are destitute of true branches. The chlorophyll masses are arranged in plates, bands, or stellate masses. Starch-grains are abundant. Multiplication by division in one direction. Reproduction by zygospores resulting from copulation and conjugation of two cells, or by azygospores formed without copulation. There are two families that are very different in their general characteristics, but that agree in their mode of reproduction.

FAMILY DESMIDIEÆ.—The Desmidiæ, or Desmids, form a large, well-defined group of unicellular algæ. They are characterized by two peculiar features—by an apparent division of the cell into two symmetrical halves, and by the presence of projections from the surface, either inconspicuous or prolonged into spines. The cells are of various sizes and forms, often curious or ornamental, single or joined together forming a filament. The transverse constriction is sometimes deep, sometimes slight, and occasionally absent. The cell-wall is firm, almost horny. Some writers have imagined that it was slightly silicified. The cell is surrounded by a mucous covering and sometimes by a layer of gelatin. The cell-contents are green and granular. Starch-grains are numerous. At the ends of some of the cells there are clear spaces in which are seen granules that occasionally have a vibratory movement. Cyclosis, or a circulation of granules in the watery fluid next the cell-wall, may be observed

in some species. Some species of desmids exhibit voluntary movements of the entire cell. *Closterium*, for example, shows certain oscillations and backward and forward gliding movements, supposed to be due to the secretion of threads of mucous. Multiplication takes place by cell-division and by conjugation. In the first case the two halves of the cell stretch apart and become separated by a transverse partition; new halves ultimately form on each of the original halves, so that two symmetrical cells result. These afterward separate. (See Pl. VIII, Fig. A.) Sexual propagation by conjugation takes place as follows: Two cells approach and each sends out a tube from its center. These tubes meet, swell hemispherically, and, by the disappearance of the separating wall, become united into a rounded zygospore with a thick tegument and sometimes with bristling projections. This zygospore, after a period of rest, loses its contents through a rent in the wall, and a new cell is formed which ultimately becomes constricted and assumes the shape of the parent cell. (See Pl. VIII, Figs. B to F.)

Some of the common genera are described below. The enormous number of species makes a detailed analysis impracticable.

#### **Penium.**

Cells straight, cylindrical or fusiform, not incised nor constricted in the middle; ends rounded. Chlorophyll lamina axillary; containing starch-granules. Cell-membrane smooth, finely granulated, or longitudinally striated. Individuals free-swimming or associated in gelatinous masses. (Pl. VII, Fig. 7.)

#### **Closterium.**

Cells simple, elongated, lunate or crescent-shaped, entire, not constricted at the center. Cell-wall thin, smooth or somewhat striated. The chlorophyllaceous masses are generally arranged in longitudinal laminæ, interrupted in the middle by a pale transverse band. At each end there is a clear, colorless, or yellowish vacuole in which minute "dancing granules" may be seen. (Pl. VII, Figs. 8 to 10.)

#### **Docidium.**

Cells, straight, cylindrical or fusiform, elongated, constricted at the middle. The semi-cells are somewhat inflated at the base and are often separated by a suture. Ends rounded, truncated or divided. Transverse section circular. The chlorophyllaceous cytoplasm has a parietal or axillary arrangement. Terminal vacuoles with "dancing granules" are observed in some species. (Pl. VII, Fig. 11.)

#### **Cosmarium.**

Cells oblong, cylindrical, elliptical, or orbicular, with margins smooth, dentate, or crenate; deeply constricted; ends rounded

or truncate and entire; end view oblong or oval. Chlorophyll masses parietal or concentrated in the center of the semi-cells. Cell-walls smooth, punctate, warty, or rarely spinous. The zygospore is spherical, tuberculated or spinous. (Pl. VII, Fig. 12, and Pl. VIII, Figs. A to F.)

**Tetmemorus.**

Cells cylindrical or fusiform, slightly constricted in the middle, narrowly incised at each end, but otherwise entire. Cell-wall punctate or granulate. (Pl. VII, Fig. 13.)

**Xanthidium.**

Cells single or geminately concatenate, inflated, very deeply constricted; semi-cells compressed, entire, spinous, protruding in the center as a rounded, truncate, or denticulate tubercle. Cell-wall firm, armed with simple or divided spines. The zygospores are globose, smooth or spinous. (Pl. VIII, Figs. 1 and 2.)

**Arthrodesmus.**

Cells simple, compressed, deeply constricted; semi-cells broader than long, with a single spine on each side, but otherwise smooth and entire. (Pl. VIII, Fig. 3.)

**Euastrum.**

Cells oblong or elliptical, deeply constricted; semi-cells emarginate and usually incised at their ends; sides symmetrically sinuate or lobed, provided with circular inflated protuberances; viewed from the vertex, elliptical. The zygospores are spherical, tuberculose or spinous. (Pl. VIII, Fig. 4.)

**Micrasterias.**

Cells simple, lenticular, deeply constricted; viewed from front, orbicular or broadly elliptical; viewed from the vertex, fusiform, with acute ends; semi-cells three- or five-lobed; lateral lobes entire or incised; end lobes sinuate or emarginate and sometimes with angles bifid or produced. (Pl. VIII, Fig. 5.)

**Staurastrum.**

Cells somewhat similar to those of *Cosmarium* in front view, but angular in end view; angles obtuse, acute, or drawn out into horn-like processes. Cell-wall smooth, punctate or granular, hairy, spinulose, or extended into arms or hair-like processes. Chlorophyll masses concentrated at the center of the semi-cells, with radiating margins. The zygospores are spined. (Pl. VIII, Figs. 6 and 7.)

**Hyalotheca.**

Cells short, cylindrical, usually with a slight obtuse constriction in the middle; circular in end view. The cells are closely united

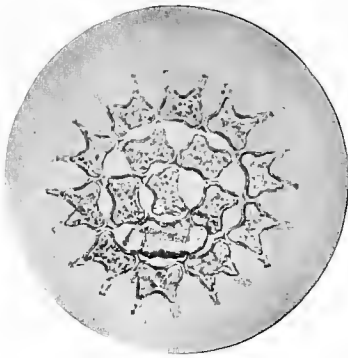

Pediatrum.

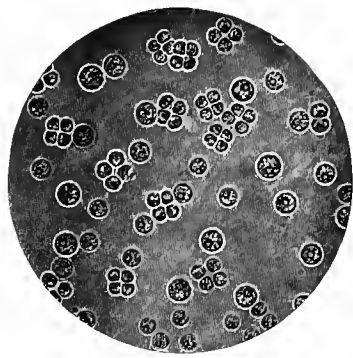

Tetraspora.

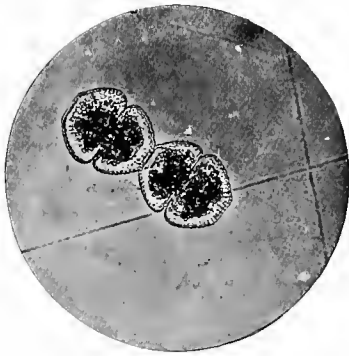

Cosmarium.



Cymbella.

PLATE E.

Photomicrographs of Microscopic Organisms.

into long filaments, enclosed in an ample, colorless mucous sheath. The chlorophyll is concentrated in a mass which, in end view, has a radiate appearance. (Pl. IX, Fig. 1.)

#### **Desmidium.**

Cells oblong-tabulate, somewhat incised; in end view, triangular or quadrangular; united into somewhat fragile filaments and surrounded by a colorless mucous sheath. Chlorophyll masses in each semi-cell concentrated and radiate to the angles. Zygospores smooth, globose or oblong. (Pl. IX, Fig. 2.)

#### **Sphærozosma.**

Cells bi-lobed, elliptical, or compressed, deeply incised, forming filaments which are almost moniliform or pinnatifid, surrounded by a colorless or mucous sheath. Chlorophyll mass concentrated, somewhat radiate. (Pl. IX, Fig. 3.)

**FAMILY ZYGNEMACEÆ.**—Multicellular plants, composed of cylindrical cells joined into filaments and forming an articulated simple thread. Cell-wall lamellose. Chlorophyll arranged as twin stellate nuclei, as axillary laminæ, or as spiral bands. Starch-grains, etc., conspicuous. Propagation by zygospores resulting from copulation, which takes place by the union of two filaments. The filaments come into proximity, the cells put out short processes, which unite, forming tubular passages between pairs of cells. Through these connecting tubes the cell-contents of one cell passes into and unites with the cell-contents of another. This results in the formation of a zygospore often clothed with a triple membrane. Copulation is said to be scalariform when opposite cells of two filaments unite by ladder-like tubes, geniculate when the cells become bent and unite at the angles, and lateral when the process takes place between two adjoining cells of the same filament. The family is sometimes divided into two sections, the *Zygnemina* and *Mesocarpina*. In the second section the spore formed is not a true zygospore. It is formed by a flowing together of only a part of the cell-contents. The zygospores germinate by putting forth a single germ, which elongates by transverse division into a filament.

#### **Spirogyra.**

Cells cylindrical, sometimes replicate, or folded in at the ends. Chlorophyll arranged in one or several parietal spiral bands winding to the right. Copulation scalariform, sometimes lateral. Copulating cells often shorter than sterile ones and more or less swollen. Zygospores always within the wall of one of the united cells. There are very many species, differing in size of cells, number and arrangement of spirals, replication at the end of cells, character of the zygospore, etc. (Pl. IX, Figs. 4 and 5.)

**Zygnema.**

Cells with two-axil, many-rayed chlorophyll bodies near the central cell-nucleus, containing one or more starch-granules. Copulation scalariform or lateral. Zygospore in one of the united cells. (Pl. IX, Fig. 6.)

**Zygonium.**

Like Zygnema, except that the zygospores are located in the connecting tube between the united cells.

**ORDER IV. SIPHONEÆ.**

Unicellular plants when in the vegetative state; cells tubular or utricle-shaped, often branched. Cell-contents green, granular. Propagation by sexual fertilization, asexual zoospores, or by microgonidia.

FAMILY VAUCHERIACEÆ.—Plants consisting of elongated, robust tubular filaments, more or less branched, growing in tufts. Chlorophyll granules are evenly distributed on the inside walls of the cells, and starch-grains and oil globules are conspicuous. Sexual propagation takes place by means of oospores fertilized by spermatozoids. The oogonia are lateral, sessile, or borne on a simple pedicel; the antheridia usually develop on the same filament. Asexual propagation takes place by means of zoospores produced in a terminal sporangium. The zoospores are ciliated, but go through a resting period before germinating. Propagation also takes place by means of microgonidia produced in the vegetative cells.

**Vaucheria.**

The characteristics are described under the family. There are many species, aquatic and terrestrial. (Pl. IX, Fig. 7.)

**ORDER V. CONFERVOIDEÆ (NEMATOPHYCEÆ)**

Multicellular plants consisting of simple or branched filaments forming articulated threads or membranaceous thalli. Vegetation terminal, sometimes lateral. Propagation by oospores fertilized by spermatozoids, or by copulation of zoogonidia. In many of the genera the method of propagation is not well known. The order contains a great variety of forms, and various methods of classification have been adopted by

different writers. There are but few genera that interest the water analyst.

**FAMILY CONFERVACEÆ.**—Plants consisting of simple or branched filaments, with terminal vegetation, composed of elongated, cylindrical cells, rarely abbreviated or swollen. Cell-membrane sometimes lamellose. Vegetation by division in one direction. Propagation by zoospores.

#### **Conferva.**

Articulate threads simple; cells cylindrical, sometimes swollen; chlorophyll homogeneous. Vegetation by division. Propagation by zoogonidia. There are many common species, varying greatly in diameter of filaments. Many vegetative filaments of other plants are liable to be mistaken for *Conferva*. The characteristics of the genus are somewhat vague. (Pl. IX, Fig. 8.)

#### **Cladophora.**

Articulate threads very much branched, the branched cells being much thinner than the primary cells. Cell-membrane thick, lamellose. Cells cylindrical, somewhat swollen. Cell-contents green, containing many starch-granules. Propagation by zoogonidia, which develop in large numbers. (Pl. IX, Fig. 9.)

**FAMILY ŒDOGONIACEÆ.**—Filaments articulated, simple or branched. Cells cylindrical, terminal cells sometimes setiform. Propagation by asexual zoospores or by oospores sexually fertilized. Plants monœcious or diœcious; when diœcious the male plants are either dwarf, i.e., produced from short cells of the female plants, or elongated and independent. There are two genera, *Œdognium* and *Bulbochæte*, each with many species.

**FAMILY ULOTRICHEÆ.**—Filaments shortly articulate, simple, free, sometimes laterally connate in bands. Cell-membrane thick and lamellose. Cell-contents at first effused, after division transmuted into gonidia. Propagation by ciliated macrospores which do not copulate, or by microzoospores which do or do not copulate.

#### **Ulothrix.**

Filaments simple, articulate. Articulations usually shorter than their diameter. Cell-membrane thin. Cell-contents green, effused or parietal, enclosing amylaceous granules. Propagation by macro- and micro-zoospores. Several common species. (Pl. IX, Fig. 10.)

**FAMILY CHÆTOPHORACEÆ.**—Filaments articulate, dichotomously or fasciculately branched, accumulated in tufts in a gelatinous mucus, or constituting a filamentose or foliaceous thallus. Propagation by oospores sexually fertilized, or by zoogonidia. Monœcious or diœcious.

**Stigeoclonium.**

Filaments articulate, with simple scattered branches. Branches similar to the stems, attenuated into a colorless bristle. Cell-membrane thin, hyaline. Cell-contents green, with chlorophyll arranged in transverse bands. Propagation by oospores or zoogonidia. (Pl. X, Fig. 2.)

**Draparnaldia.**

Filaments articulate, much branched; the main stem comparatively thick, composed of large, mostly hyaline cells, with broad, transverse chlorophyll bands. Many branches and sub-branches, alternate or opposite. The terminal cells are empty, hyaline, and often elongated into a bristle. The branch cells only are fertile. The plant is enveloped in a gelatinous covering. Propagation by resting-spores or zoogonidia. There are few species. (Pl. X, Fig. 1.)

**Chætophora.**

Filaments articulate, with primary branches radiately disposed, and secondary branches shortly articulate, and attenuated into a bristle, the whole involved in a gelatinous mass. Propagation by zoospores. (Pl. X, Fig. 3.)

**ORDER VI. CHARACEÆ**

The Characeæ are plants which occupy an intermediate position between the algæ and the higher cryptogams. Each plant consists of an assemblage of long tubular cells, having a distinct central axis, with whorls of branches projecting at regular intervals at points called "nodes." The branches are sometimes spoken of as leaves, but they are quite similar to the stem. At the lower end of the stem some of the branches (rhizoids) are root-like and serve to give attachment and stability to the plant. Reproduction takes place by a peculiar sexual process. Oospheres or archegones form at the base of the branches and are fertilized by peculiar antherozoids found near them.

There are two common genera—*Nitella* and *Chara*. In *Nitella* the stems and branches are simple and naked; the leaves are in whorls of 5 to 8 and without stipules; the leaflets are large and often many-celled; the sporocarps arise singly or in clusters in the forkings of the leaves, and each has a

crown of two superimposed whorls of five cells each. In *Chara* the stems and lower branches are usually corticated, i.e., there is a central tube surrounded by smaller tubes, sometimes spirally arranged, forming a cortex; the leaves are in whorls of 6 to 12, and usually with one or two stipules; the leaflets are always one-celled; the sporocarps arise from the upper side of the leaves, and each has a crown of one whorl of five cells. These plants exhibit beautifully the phenomenon of cyclosis, or circulation of protoplasm. Some species of *Chara* secrete calcium carbonate, and from this arises their popular name, "stone-worts." (Pl. XIX, Fig. 8.)

## REFERENCES

- COOKE, M. C. 1890. Introduction to Fresh-water Algæ, with an enumeration of all the British Species. Kegan Paul, Trench, Trübner & Co., Ltd.
- COOKE, M. C. 1882. British Fresh-water Algæ. 2 vols. London: Williams & Norgate.
- COOKE, M. C. 1886. British Desmids. London: Williams & Norgate.
- HASSALL, A. H. 1857. A History of the British Fresh-water Algæ, including Desmidiæ and Diatomaceæ. 2 vols. London.
- OLTMANN, DR. FRIEDR. 1904-5. Morphologi und Biologie der Algen. Part I. Special. Part II. General. Pub. by Gustav Fischer, Jena.
- RALFS, D. 1848. The British Desmidiæ. London.
- STOKES, A. C. Analytical Keys to the Genera and Species of the Fresh-water Algæ and the Desmidiæ of the U. S. Edw. F. Bigelow, Portland, Conn.
- WOLLE, FRANCIS. 1892. Desmids of the United States. 2d edition. Bethlehem, Pa.
- WOLLE, FRANCIS. 1887. Fresh-water Algæ of the United States. 2 vols. Bethlehem, Pa.

(See also page 393.)

## CHAPTER XXIV

### FUNGI

FUNGI are flowerless plants in which the special characteristic is the absence of chlorophyll and starch. Lacking these, they are unable to assimilate inorganic matter, and consequently live a saprophytic or a parasitic existence, that is, they live upon dead organic matter or in or upon some living host. They are essentially terrestrial plants, but some of them live a sort of semi-aquatic life.

Many very different forms are included among the Fungi. On the one hand there are microscopic forms—and among them some authors include the bacteria, because they have no chlorophyll—and on the other hand there are the mushrooms, etc., which are often of very large size. Fungi usually consists of two parts, the mycelium and the fruit. The mycelium is the vegetative portion of the plant. It is a mass of delicate, jointed, branched, colorless filaments intertwined to form a cottony or felty layer. It is the spawn of mushrooms and the common mold or mildew seen on decaying vegetable matter. The fruit consists of certain terminal mycelium filaments erected from the general mass and bearing spore-cells of various kinds. It is by differences in the method of fruiting or reproduction that the different fungi are distinguished from each other.

The Fungi, as a class, are of little importance in water investigation. They are more often seen in sewage, and even there the number of important genera is small. For this reason a general classification of the Fungi is not given here, but simply a description of a few common genera.

## ORDER SACCHAROMYCETES.

**Saccharomyces.**

Cells oval or somewhat rounded, colorless, with numerous vacuoles. They do not divide by the ordinary process of cell-division, but increase by a sort of sprouting or budding. A knob-like protuberance appears at one side of the cell; this increases in size and gradually assumes the form of the mother cell; it then separates and itself begins to bud, or it remains attached, forming a sort of irregular beading or branching. It does not develop true mycelia. It also reproduces by means of certain large cells whose protoplasm divides and forms several spores, sometimes called ascospores. There is no sexual reproduction. The Saccharomycetes are popularly called yeasts. They are well known for the alcoholic fermentation which they produce in sugar. The *S. cerevisiæ* is the common beer-yeast. Its cells average about  $8 \mu$  in diameter. There are other species which differ in the shape and size of the cells, in the character of the spores, in the temperature and time at which sprouting takes place, in the capacity to ferment sugars, in the time required to form yeast-films in the fermenting liquid, etc. (Pl. X, Fig. 4.)

## ORDER ASCOMYCETES.

**Penicillium.**

This is the common "blue mold." The mycelium is composed of very many colorless, more or less branched filaments or hyphæ. The fertile hyphæ are erect and septate, and branch into a series of compound branches, each of which bears simple sterigmata upon which chains of oval conidia are borne. The most common species is *P. glaucum*. It has a pale bluish-green color. Its erect septate hyphæ are 1 to 2 mm. long, bearing a minute brush-like cluster of greenish conidia  $2-4 \mu$  in diameter. (Pl. X, Figs. 5 and 6.)

**Aspergillus.**

Mycelium as in *Penicillium*. Fertile hyphæ unseptate, swollen at apex (columella), bearing simple flask-shaped sterigmata, with chains of elliptical or spherical conidia. Often small yellowish or reddish bodies (perithecia or sclerotia) are found upon the sterile hyphæ at the base of the fertile branches. *A. repens* is a common species. The color is light greenish or brownish. Fertile hyphæ 2-4 mm. high,  $10 \mu$  diam.; columella  $10-30 \mu$ , head of conidia  $100 \mu$ , conidia  $5 \mu$ . (Pl. X, Fig. 7.)

## ORDER PHYCOMYCETES.

## FAMILY MUCORACEÆ.

**Mucor.**

Mycelium saprophytic or parasitic, richly branched, forming a felt-like layer. The hyphæ are seldom divided by septa. Conidia formed in sporangia which are spherical and borne on erect hyphæ. A common species is *M. racemosus*. Its sporangia are numerous, 20-70  $\mu$  in diameter, on the ends of long hyphæ. The spores are smooth, spherical, 4-8  $\mu$  in diameter. Secondary sporangia are sometimes seen on the main fruiting-branch. The color is whitish, and later a tawny brown. There are many other species, some of which produce alcoholic fermentation in sugar. (Pl. X, Fig. 8.)

## FAMILY SAPROLEGNIAEÆ.

**Saprolegnia.**

Saprophytic or parasitic on plants or animals in water, sometimes producing pathogenic conditions, as, for example, in the "salmon-disease." They are often seen on dead flies, etc. The mycelium is composed of colorless or grayish hyphæ of large size attached to the substratum by root-like processes. The hyphæ are not constricted, as in *Leptomitius*. Sexual reproduction takes place by means of fertilized oospores. Asexual reproduction takes place by zoospores produced in special club-shaped zoosporanges which are borne terminally upon certain hyphæ. The zoospores are numerous, sometimes in rows; they are bi-ciliated and motile even within the zoosporangium. After escaping from the zoosporangium they become covered with a thin membrane which they throw off before final swarming and germination. (Pl. XI, Fig. 1.)

**Achlya.**

Mycelium similar to that of *Saprolegnia*. The zoospores are non-motile when they escape from the zoosporangium. They arrange themselves in globular fashion outside the apex of the sporangium, assume a thin membrane, rest for a time, and ultimately escape, swim about, and germinate. (Pl. XI, Fig. 2.)

**Leptomitius.**

Hyphæ long, cylindrical, deeply constricted at intervals and at the base of the branches. Near the constriction there is usually a globular body, like an oil globule. The grayish protoplasm is sometimes arranged in concentrated masses, and sometimes is uniformly distributed. The zoospores are formed in the interior of club-shaped terminal sporangia. They resemble those of *Saprolegnia*. *Leptomitius* is often found in masses in pipes conveying sewage or on the banks of polluted streams. (Pl. XI, Fig. 3.)

## CHAPTER XXV

### PROTOZOA

THE Protozoa are the lowest organisms belonging to the animal kingdom. The name Protozoa was used by the early writers to describe all minute organisms, whether animal or vegetable, but of late it has come to have a more definite meaning. It is now applied to those animal forms which are unicellular or multicellular by aggregation. Structurally the Protozoa are single cells, and where there is an aggregation of several cells each one preserves its identity. There is no differentiation, no difference in the function of the different cells. Thus, the Protozoa are definitely set off from the Metazoa or Enterozoa, which are multicellular, and which have two groups of cells, one group forming the lining to a digestive cavity and the other group forming the body-wall, which differ both in structure and in function. Most of the Protozoa are strictly unicellular.

It is extremely difficult to separate the unicellular Protozoa from the unicellular Protophyta. Theoretically there is a sharp distinction between the animal and vegetable kingdoms. Definitions may be found applicable to the higher types of life, but they overlap and become confused when applied to the lowest forms. For example, the fundamental difference between the two kingdoms is supposed to lie in the phenomenon of nutrition. Plants can take up the carbon, oxygen, hydrogen, and nitrogen from mineral matter dissolved in water—the nitrogen in the form of ammonia or nitrates, the carbon in the form of carbonic acid. Their food is in solution; hence they need no mouth or digestive apparatus. They absorb their nourishment through their entire surface.

Animals, however, cannot take up nitrogen in a lower state than is found in the albumens, nor carbon except in combination with oxygen and hydrogen in the form of fat, sugar, starch, etc. The albumens and fats are not soluble in water; consequently the food of animals must consist of more or less solid particles. Animals therefore require a mouth, digestive cavity, organs for obtaining their food, etc. As albumens, fats, etc., are found in nature only as products of plant or animal life, it follows that all animal life is dependent upon vegetable or other animal life. There are, however, certain plants that live on organic matter (insectivorous plants, pitcher-plants) and even have digestive cavities, but all their relations show that they are real plants. There are other plants that are devoid of chlorophyll (Fungi), yet no one would think of calling them animals. Then there are many unicellular organisms that contain chlorophyll and have the vegetable, or holophytic, mode of nutrition, but that resemble the animal kingdom in other respects. Such, for example, are the Dinoflagellata and many of the green Flagellata. Because it is difficult to draw a sharp line between the vegetable and animal unicellular forms Haeckel proposed a new group, the Protista, lying between the two kingdoms. This group has been since known as the Phytozoa. The term is not used in this work but the organisms have been placed in the one or the other of the two kingdoms according to the best available authority.

**The Protozoan Cell.**—The protozoan cell, or the individual protozoan, is a single mass of sarcode, or protoplasm, that possesses in a general way all the properties of the protoplasm of higher animal cells. It has a certain amount of irritability and movement, it assimilates food, it grows, and reproduces its kind. It is subject to the same chemical and physical reactions that are observed in higher forms. In size it varies from the tiniest corpuscle to a mass an inch in diameter. It is irregular in form, without a definite boundary; or it has a cell-wall and a definite symmetrical outline. Internally the cell usually contains a solid nucleus or a nuclear

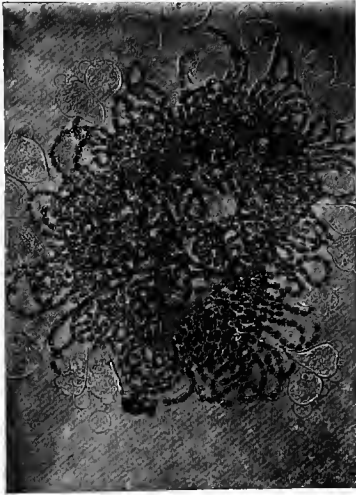

Cylindrospermum and Vorticella.

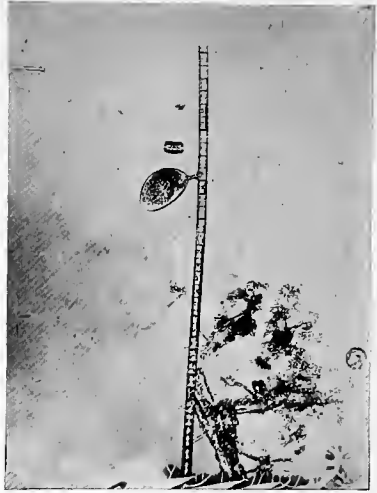

Melosira.

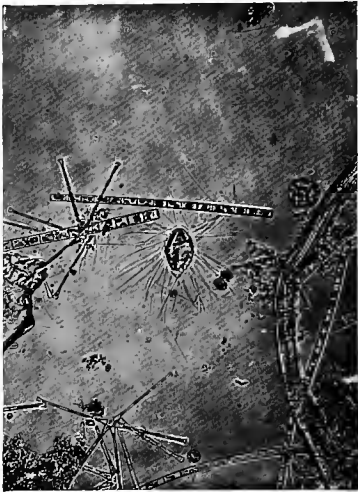

Mallomonas, etc.



Acineta.

PLATE F.

Photomicrographs of Microscopic Organisms.

substance distributed through the cell and recognized by staining. It usually contains a contractile vacuole, which may be seen to expand and contract, discharging a watery or gaseous matter through the cell. There are also permanent vacuoles of watery fluid, gastric vacuoles formed by the water taken in with the food, oil globules, and solid particles of starch, chlorophyll, etc. Externally there may be a cortical substance—a denser layer of protoplasm giving definite shape to the cell—that is sometimes contractile. The exterior protoplasm may contain such secreted products as chitin, a nitrogenous horny matter, or cellulose, a non-nitrogenous substance, forming a cell-wall, cell-cuticle, or matrix. Substances may be deposited even outside of the protoplasmic layer. If perforated they are known as shells; if closed entirely, as cysts. Cysts are usually of a horny nature and are temporary products. External secretions of calcium carbonate, silicates, etc., are sometimes present.

The cell-protoplasm often exhibits certain internal flowing movements, described as the “streaming of the protoplasm.” Portions of the protoplasm often extend outward, forming processes. These are of two kinds, and the distinction between them has been used as a basis of classification. Those protozoa that have lobose, filamentous processes, known as pseudopodia, are called Myxopods; those that have motile hair-like processes, known as cilia or flagella, are called Mastigopods.

The simplest Protozoa absorb solid particles of food at any point on their surface. Digestion takes place within the cell. Protozoa higher in the scale of life have a distinct oral aperture through which the food enters, a sort of pharyngeal passage, and an anal aperture through which undigested portions of food are expelled. There is no real digestive cavity. Some Protozoa exhibit a simple kind of respiration. Experiment has shown that they take up oxygen and give out carbonic acid. Multiplication takes place by binary division, by encystment and spore-formation, by conjugation followed by spore-formation, or by conjugation followed by increased power of division. Strictly there is no sexual reproduction,

though in certain instances there are processes corresponding to it.

Various classifications have been suggested for the Protozoa. None are entirely satisfactory. Bütschli has divided the Protozoa into four classes: the Sarcoda, Sporozoa, Mastigophora, and Infusoria. So far as fresh-water forms are concerned, the Sarcoda represent the Rhizopoda as described by Leidy. The Mastigophora and Infusoria are both included by the word Infusoria as used by Kent. Bütschli's classification with some modifications is given below, so far as it relates to the forms with which the water analyst is concerned. Many families and some entire orders are omitted.

### CLASS RHIZOPODA.

Protozoa provided with variable, retractile root-like processes or pseudopodia; naked or enclosed in a carapace or external skeleton that is chitinous, calcareous, or siliceous; generally one and sometimes more than one nucleus; contractile vacuole present or absent.

There are five sub-classes—Lobosa, Reticularia, Heliozoa, Radiolaria, and Labyrinthulidea. The two latter are marine forms and therefore are omitted. The Lobosa and Reticularia are creeping animals; the Heliozoa are swimmers.

#### SUB-CLASS LOBOSA

Rhizopoda in which the "amœba-phase" predominates in permanence and physiological importance. Pseudopodia lobose, not filamentous, arborescent, or reticulate. A denser external layer of protoplasm usually noticed. Provided with one or more nuclei and usually with a contractile vacuole. Reproduction commonly effected by simple fission, sometimes by a kind of budding.

#### **Amœba.**

A soft, colorless, granular mass of protoplasm; possessing extensile and contractile power; devoid of investing membrane, but having an external thickening or protoplasm; with variable, lobose, finger-

like processes; ingesting food by flowing around and engulfing it; the absorbed food-material (diatoms, algæ, etc.) is often conspicuous. There are several species that vary in size and in the character of the pseudopodia. A common habitat is the superficial ooze of ponds or ditches. (Pl. XI, Fig. 4.)

#### Arcella.

An amoeba-like organism enclosed in a chitinous shell that is variable in shape, but more or less campanulate or dome-shaped, and that has a circular, somewhat concave base. When seen from above, it is disk-shaped, with a pale circular spot in the middle; when seen from the side, the upper surface is strongly convex. The shell usually has a brown color, and is sometimes smooth and sometimes hexagonally marked. The protoplasmic mass occupies the central portion of the shell, but pseudopodia project through an opening in the concave base. There are many species, differing in shape and in the marks, ridges, etc., on the shell. *A. vulgaris* is the most common. (Pl. XI, Figs. 5 and 6.)

#### Diffugia.

Body enclosed in a spherical or pear-shaped membrane in which sand-grains, etc., are embedded. The lower part is sometimes prolonged as a neck, at the end of which is situated the mouth, through which finger-like pseudopodia may project. The surface of the shell is very rough and usually has a brownish or a gray color. Diatoms, etc., are frequently attached to the shell. The contained protoplasmic mass frequently has a green color, but the pseudopodia are colorless. There are several species, varying in shape and size. The diameter of *Diffugia* shells varies from 35 to 300  $\mu$ . (Pl. XI, Fig. 7.)

### SUB-CLASS RETICULARIA

Rhizopoda covered with a secreted shell-like membrane with agglutinated particles of lime or sand. The projected pseudopodia are not finger-like, as in the Lobosa, but thread-like and delicately and acutely branched. The external denser layer of protoplasm is not as well marked as in the Lobosa. The shell is sometimes perforated by apertures.

#### Euglypha.

Body enclosed in a hyaline, ovoid shell, composed of regular hexagonal plates of chitinous membrane, arranged in alternating longitudinal series. At the mouth the plates form a serrated margin. The upper portion of the shell is sometimes provided with spines.

The protoplasm is almost entirely enclosed by the shell; the pseudopodia are delicate and branched. There are several species. (Pl. XI, Fig. 8.)

#### **Trinema.**

Body enclosed in a hyaline, pouch-like shell, with long axis inclined or oblique, and with mouth subterminal. Dome rounded; mouth inverted, circular, beaded at border. Pseudopodia as in *Euglypha*, but fewer in number. The two genera are quite similar, but *Trinema* is usually much smaller. One species. (Pl. XI, Fig. 9.)

### SUB-CLASS HELIOZOA

Rhizopoda generally spherical in form, with numerous radial, filamentous pseudopodia, which ordinarily exhibit little change of form, though they are elastic and contractile. Protoplasm richly vacuolated. One or more nuclei and contractile vacuoles. Chlorophyll grains sometimes present. Skeleton products sometimes present. The Heliozoa are generally found in fresh water. They are closely related to the marine Radiolaria.

#### **Actinophrys.**

A spherical mass of colorless protoplasm seemingly filled with small bubbles, with numerous long, fine rays springing from all parts of the surface. Contractile vesicle large and active. The organism moves with a slow gliding motion. It feeds on smaller protozoa, algæ-spores, etc. The most important species is *A. sol*, otherwise known as the "sun-animalcule." It is very common in swamp water. (Pl. XI, Fig. 10.)

#### **Heterophrys.**

Like *Actinophrys* in general form, but with the body enveloped with a thick stratum of protoplasm defined by a granulated or thickly villous surface and penetrated by the pseudopodal rays.

### CLASS MASTIGOPHORA

Protozoa bearing one or more lash-like flagella, occasionally supplemented by cilia, pseudopodia, etc. With an indistinct, diffuse, or definite ingestive system, and usually with one or more contractile vesicles. Multiplication takes place by fission and by sporulation of the entire body mass, the process often being preceded by conjugation of two or more zooids. The

term Flagellata is used by some writers to describe this class of Protozoa.

#### SUB-CLASS FLAGELLATA

Nucleated cells, with a definite, corticate, external layer of protoplasm and provided with one or more vibratile flagella. Food commonly ingested through an oral aperture in the cortical protoplasm, though some genera contain chlorophyll and are sustained by nutritional processes resembling those of plants. In some genera the cuticle is developed into stalks or collar-like outgrowths. Others produce chitinous shells or masses of jelly and are connected into arborescent or spherical colonies. Food-particles, starch-gains, chromatophore and chlorophyll corpuscles, oil globules, pigment-spots (eye-spots) are often observed in the protoplasm of the cell.

The flagella of the Flagellata offer an interesting study. They are essentially different from cilia in their movement. Cilia are simply alternately bent and straightened. Flagella exhibit lashing movements to and fro and also throw themselves into serpentine waves. There are two kinds of flagella, distinguished by their movement—pulsella and tractella. The former serve to drive the organism forward in the manner of a tadpole's tail. These are never found on the Flagellata. The tractellum is carried in front of the body and draws the organism after it, as a man uses his arms in swimming. The flagella of the Flagellata are always tractella.

#### ORDER MONADINA

Small, simple Flagellata, often naked or amoeboid, usually colorless, seldom with chromatophores. With a single, large, anterior flagellum or sometimes with two additional flagella. Mouth area often wanting, never produced into a well-developed pharynx.

#### FAMILY CERCOMONADINA.

##### **Cercomonas.**

Animalcules free-swimming, ovate or elongate, plastic, with a single long flagellum at anterior extremity and a caudal filament

at the opposite extremity; no oral aperture. There are several species. Their length varies from 10 to 25  $\mu$ . (Pl. XII, Fig. 1.)

#### FAMILY HETEROMONADINA.

##### Monas.

Very minute, free-swimming animalcules, colorless, globose or ovate, plastic, with no distinct cuticle; flagellum single, terminal; no distinct mouth. Several species, commonly found in vegetable infusions. Their length varies from 2 to 10  $\mu$ . They move with a "swarming" motion. (Pl. XII, Fig. 2.)

##### Anthophysa.

Animalcules colorless, obliquely pyriform, attached in spherical clusters to the extremities of slightly flexible, granular, opaque, more or less branching pedicles; two flagella, one longer than the other; no distinct mouth. In the common species, *A. vegetans*, the pedicle is dark brown and longitudinally striated. The detached stems somewhat resemble *Crenothrix* when observed with a low power. Zooids about 5  $\mu$  long; clusters 25  $\mu$  in diameter. Common in swamp water. (Pl. XII, Fig. 3.)

#### ORDER EUGLENOIDEA

Somewhat large and highly developed monoflagellate forms, with firm, contractile, elastic cortical substance; some forms are stiff, others are capable of annular contraction and worm-like elongation. At the base of the flagellum there is a mouth leading into a pharyngeal tube, near which is a contractile vacuole. Rarely with two flagella.

#### FAMILY CÆLOMONADINA.

##### Cœlomonas.

Animalcules free-swimming, monoflagellate, highly contractile and variable in form, with distinct oral aperture and a spheroidal pharyngeal chamber; nucleus and contractile vacuole conspicuous; no trichocysts; with innumerable green chlorophyll granules. Nutrition largely vegetal. One species. Length about 50  $\mu$ . (Pl. XII, Fig. 4.)

##### Raphidomonas (*Gonyostomum*).

Animalcules free-swimming; ovate-elongate, flexible body, widest anteriorly and tapering posteriorly, two to three times as long as wide; two flagella, one of them trailing; oral aperture at anterior

end conducts to a conspicuous triangular or lunate pharyngeal chamber; contractile vacuole conspicuous; nucleus ovate; a brownish germ-sphere posteriorly located; many large bright green chlorophyll bodies; numerous rod-like bodies called trichocysts; oil globules often present. Length 40 to 70  $\mu$ . Reproduction by spores formed in the germ-sphere. One species, *R. semen*. The genus *Trentonia*, described by Dr. A. C. Stokes, is similar to *Raphidomonas* except that it has no trichocysts. (Pl. XII, Fig. 5.)

#### FAMILY EUGLENINA.

##### **Euglena.**

Free-swimming animalcules, fusiform or elongate, exceedingly flexible in form; with highly elastic cuticle terminating posteriorly in a tail-like prolongation; endoplasm bright green or reddish; flagellum flexible, issuing from an anterior notch at the bottom of which is the oral aperture and a red pigment-spot. There are several common species. *E. viridis* is the most common. It is often found in immense numbers in stagnant pools, forming a characteristic green or reddish scum. Length varies from 40 to 150  $\mu$ . *E. acus* is an elongated form with tapering ends. It is longer than *E. viridis*, but less broad. It is also less variable in form. *E. deses* is a very long cylindrical form. (Pl. XII, Fig. 6.)

##### **Trachelomonas.**

Monoflagellate animalcules, changeable in form, enclosed within a free-floating, spheroidal, indurated sheath or lorica; flagellum protruded through an aperture in the lorica. The color of the animalcule is green, with a red pigment-spot; the color of the lorica is generally a reddish-brown. There are several species. Diameter of lorica generally about 25  $\mu$ . (Pl. XII, Fig. 7.)

##### **Phacus.**

Free-swimming animalcules; form persistent, leaf-like, with sharp-pointed, tail-like prolongation; terminal oral aperture and tubular pharynx; flagellum long, vibratile; surface indurated; endoplasm green, with red pigment-spot; contractile vacuole large, subspherical. Length about 50  $\mu$ , but quite variable. (Pl. XII, Fig. 8.)

#### ORDER ISOMASTIGODA

Small and middle-sized forms of monaxonic, rarely bilateral shape. Fore end with two or more flagella. Some are colored, some colorless; naked or with strong cuticle or secreting an envelope. Nutrition generally holophytic (i.e. like a green plant).

## FAMILY CHRYSOMONADINA.

**Synura.**

Free-swimming animalcules, united in subspherical social clusters, each zooid contained in a separate membranous sheath or lorica, the posterior extremities of which are stalk-like and confluent; two subequal flagella, sometimes long; pigment-spots minute or absent; two brown color-bands produced equally throughout the length of the two lateral borders; a vacuolar space at the anterior extremity and several contractile vacuoles; oil globules often observed. Length of individual zooids about 35  $\mu$ ; diameter of clusters varies from 30 to 100  $\mu$ . There is one species, *S. uvella*, with several varieties. The colonies move with a brisk rolling motion, caused by the combined action of the flagella. Common in swamp waters. (Pl. XII, Fig. 9.)

**Uvella.**

An uncertain genus. *Uvella* differs from *Synura* in the non-possession of a separate investing membrane or lorica and by the posterior location of the contractile vacuole. There are usually few zooids in the cluster. (Pl. XII, Fig. 10.)

**Syncrypta.**

Free-swimming animalcules, united into spherical clusters as in *Synura*, without lorica, but with the entire colony immersed within a gelatinous matrix, beyond the periphery of which the flagella alone project; two subequal flagella; brownish lateral color-bands evenly developed; one or two pigment-spots; contractile vacuole between the color-bands. Length of zooids about 10  $\mu$ . Diameter of colony about 50  $\mu$ , including gelatinous zoogloea. There is but one species, *S. volvox*. It resembles *Synura*. It is not common. (Pl. XII, Fig. 11.)

**Uroglena.**

Animalcules forming almost colorless spheroidal colonies barely visible to the naked eye. The matrix of the colony is a transparent gelatinous shell filled with a watery substance. The zooids are embedded on the periphery, with their flagella extending outward and by their vibration causing the colony to revolve. The zooids are pyriform, with anterior border rounded and truncated, tapering posteriorly and sometimes continued backward as a contractile thread; with two light yellowish-green pigment-bands; one eye-spot at the base of the flagella; two unequal flagella; one or more contractile vacuoles; oil globules and a large amyloseous body often present. Length of zooids is about 6 to 12  $\mu$ . The colonies are from 200 to 500  $\mu$  in diameter. There are several

rather indistinct species. The zooids multiply by division into twos or fours. The colonies also divide, a hollow first appearing on one side, followed by a rounding at the two poles and a subsequent twisting apart. The *Uroglena* colonies are very fragile. (Pl. XII, Figs. 12 and 13.)

### Dinobyron.

Animalcules with urn- or trumpet-shaped loricae attenuated posteriorly and set one into another so as to form a compound branching polythecium. The zooids are elongate-ovate, attached to the bottom of the loricae by transparent elastic threads; two unequal flagella; two brownish or greenish lateral color-bands; a conspicuous pigment-spot; nucleus and contractile vacuole sub-central. The polythecium is constructed through the successive terminal gemmation of the zooids. Length of separate loricae 15 to 60  $\mu$ . The polythecium may contain from 2 to 500 loricae. The usual number is between 25 and 50. Reproduction takes place by spore-formation. The spores sometimes remain attached to the polythecium, or they may become scattered. When free they are liable to be mistaken for small *Cyclotella*. The spores are from 8 to 20  $\mu$  in diameter. There are several species. *D. sertularia* is the most common. (Pl. XIII, Fig. 1.)

### Cryptomonas.

Free-swimming animalcules, illoricate, but persistent in form, ovate or elongate, compressed asymmetrically; flagella two, long, equal in length, issuing from a deep groove or furrow; large oral aperture at the base of the flagella continued backward as a tubular pharynx; two lateral bright green color-bands; conspicuous nucleus and contractile vacuole; oil-globules often present. Length from 40 to 60  $\mu$ . (Pl. XIII, Fig. 2.)

### Mallomonas.

Free-swimming animalcules, oval or elliptical, persistent in shape; surface covered with overlapping horny plates from which arise long hair-like setae; under low power the surface has a crenulated appearance. One long, slender anterior flagellum; indistinct contractile vacuole. Endoplasm vacuolar, greenish or yellowish. Length from 20 to 40  $\mu$ . (Pl. XIII, Fig. 3.)

FAMILY CHLAMYDOMONADINA.—This family is often referred to the vegetable kingdom.

### Chlamydomonas.

Animalcules ovate, with two or more flagella, one large green color-mass, a delicate membranous shell, usually with a pigment-spot

and one or more contractile vacuoles. The protoplasm divides into new individuals within the envelope. Length from 10 to 30  $\mu$ . (Pl. XIII, Fig. 4.)

**FAMILY VOLVOCINA.**—Often included under Protozoa. See page 193.

#### SUB-CLASS CHOANOFAGELLATA

Mastigophora provided with an upstanding collar surrounding the anterior pole of the cell, from which the single flagellum springs. (Omitted from this work.)

#### SUB-CLASS DINOFLAGELLATA

Mastigophora are characterized by the presence of a longitudinal groove, marking the anterior region and the ventral surface, and from which a long flagellum projects. In every genus but one there is also a transverse groove in which lies horizontally a second flagellum, at one time mistaken for a girdle of cilia. The animalcules are bilaterally asymmetrical. They are occasionally naked, but most genera are covered with a cuticular shell of cellulose, either entire or built of plates. The endoplasm contains chlorophyll, starch-granules, and a brown coloring matter similar to that of diatoms. The nucleus is large and branching. There is no contractile vacuole. Multiplication takes place by transverse binary fission.

Because of the presence of the cellulose shell, chlorophyll, starch-granules, and a holophytic (vegetal) mode of nutrition the Dinoflagellata are often classed in the vegetable kingdom. Many of the Dinoflagellata are marine forms. Some are phosphorescent.

#### **Peridinium.**

Free-swimming animalcules enclosed within a cellulose shell composed of polygonal facets. With a high power the facets exhibit a delicate reticulation. A transverse groove divides the body into two subequal parts. A second groove extends from the first toward the apical extremity. Two flagella, one in the transverse groove, the other proceeding from the junction of the two grooves. Color yellowish green or brown. There are one or more

pigment-spots. Length from 40 to 75  $\mu$ . There are several species. *P. tabulatum* is the most common. (Pl. XIII, Fig. 5.)

#### **Ceratium.**

Free-swimming animalcules enclosed within a shell consisting of two subequal segments, one or both of which are produced into conspicuous horn-like prolongations, often covered with tooth-like processes. There is a central transverse furrow and a second groove extending from the center of the ventral aspect toward the anterior pole. Two flagella, one of which lies in the transverse groove. The brown color is not as marked as in *Peridinium*. Length from 25 to 150  $\mu$ . There are several species, varying considerably in the character of the horn-like projections. (Pl. XIII, Fig. 6.)

#### **Glenodinium.**

Free-swimming animalcules covered with a smooth, cellulose shell not made up of facets, consisting of two subequal parts. There is a conspicuous transverse groove and a much less conspicuous secondary groove. Two typical flagella. Body ovate. Color brownish. Pigment-spot sometimes present. Length about 40 to 55  $\mu$ . *Glenodinium* is often surrounded by a wide, irregular mass of jelly. (Pl. XIII, Fig. 7.)

#### **Gymnodinium.**

Quite similar to *Peridinium*, but without a protecting shell.

### SUB-CLASS CYSTOFLAGELLATA

Marine forms.

## CLASS INFUSORIA

In its broadest sense the word Infusoria includes all the Protozoa except the Rhizopoda and Sporozoa. As used here, following Bütschli, it includes only the Ciliata and Suctoria.

### SUB-CLASS CILIATA

Protozoa of relatively large size, furnished with cilia, but not with flagella. The cilia occur as a single band surrounding the oral aperture or are dispersed over the entire body. Modification of the cilia into setæ or styles is sometimes observed. There is generally a well-developed oral and anal aperture. The nucleus varies in different genera. Besides one larger, oblong nucleus a smaller one (paranucleus) is often

present. One or more contractile vacuoles present. They all possess a delicate but well-defined ectoderm, elastic, but constant in form. They occur naked or enclosed in horny or siliceous shells or in gelatinous envelopes. Some genera are stalked. Multiplication takes place by transverse fission. Conjugation has been observed, but the part that it plays in the life-history is not well known. Many of the Ciliata are parasites in higher animals.

The Ciliata are divided into four orders according to the character and distribution of their cilia.

#### ORDER HYPOTRICHA

Ciliata in which the body is flattened and the locomotive cilia are confined to the ventral surface, and are often modified and enlarged to the condition of muscular appendages. Usually an adoral band of cilia, like that of Heterotricha. Dorsal surface smooth or provided with tactile hairs only. Mouth and anus conspicuous.

##### **Euplotes.**

Animalcules free-swimming, encuirassed, elliptical or orbicular, with sharp laminate marginal edges, and usually a plane ventral, and convex, sometimes furrowed, dorsal surface. Peristome-field arcuate, extending backward from the frontal border to or beyond the center of the ventral surface, sometimes with a reflected and ciliate inner border. Frontal styles six or seven in number; three or more irregularly scattered ventral styles, and five anal styles; four isolated caudal styles along the posterior margin. Endoplast linear. Single spherical contractile vesicle near anal aperture. Length about 125  $\mu$ . (Pl. XIII, Fig. 8.)

#### ORDER PERITRICHA

Ciliata with the cilia arranged in one anterior circlet or in two, an anterior and a posterior; the general surface of the body destitute of cilia. The Peritricha are sometimes divided into two suborders, the free-swimming forms and the attached forms.

##### **Halteria.**

Animalcules free-swimming, colorless, more or less globose, terminating posteriorly in a rounded point. Oral aperture terminal,

eccentric, associated with a spiral or subcircular wreath of large cirrose cilia. A zone of long hair-like setæ or springing-hairs developed around the equatorial region, the sudden flexure of which appendages enables the organism to progress through the water by a series of leaping movements, in addition to their ordinary swimming motions. Length 15 to 30  $\mu$ . There are several species, some of them colored green. (Pl. XIII, Fig. 9.)

### **Vorticella.**

Animalcules ovate, spheroidal, or campanulate, attached posteriorly by a simple undivided, elongate and contractile, thread-like pedicle; the pedicle enclosing an elastic, spirally disposed, muscular fibrilla, and assuming suddenly on contraction a much-shortened and usually corkscrew-like contour. Adoral system consisting of a spirally convolute ciliary wreath, the right limb of which descends into the oral cleft, the left one obliquely elevated and encircling the ciliary disk. The entire adoral wreath contained within and bounded by a more or less distinctly raised border—the peristome—between which and the elevated ciliary disk, on the ventral side, the widely excavated cleft or vestibulum is situated. The vestibulum is continued further into a conspicuous cleft-like pharynx, and terminates in a narrow tubular œsophagus. Anal aperture opening into the vestibulum. Contractile vesicle single, spherical, near the vestibulum. Nucleus elongate. Multiplication by longitudinal fission, by gemmation, and by the development of germs. There exists a very large number of species, varying considerably in size and shape. The length varies from 25 to 200  $\mu$ . Vorticella are often found floating in water attached to masses of *Anabæna*, etc. (Pl. XIII, Fig. 10.)

### **Zoothamnium.**

Animalcules structurally identical with those of *Vorticella*, ovate, pyriform, or globular, often dissimilar in shape and of two sizes, stationed at the extremities of a branching, highly contractile pedicle or zoodendrium. Numerous species.

### **Epistylis.**

Animalcules campanulate, ovate, or pyriform, structurally similar to *Vorticella*, attached in numbers to a rigid, uncontractile, branching, tree-like pedicle or zoodendrium; the zooids usually of similar size and shape. Numerous species. (Pl. XIII, Fig. 11.)

## **ORDER HETEROTRICHA**

*Ciliata* possessing two distinct systems of cilia, one a band or spiral or cirlet of long cilia developed in the oral region,

the other composed of short, fine cilia covering the entire body. The cortical layer is usually highly differentiated.

#### **Tintinnus.**

Animalcules ovate or pyriform, attached posteriorly by a slender retractile pedicle within an indurated sheath or lorica. The shape of the lorica is generally cylindrical; it is free-floating; it is somewhat mucilaginous and attracts to its outer surface foreign particles, such as grains of inorganic matter, diatom-shells, etc. The peristome-field of the organism occupies the entire anterior border, circumscribed by a more or less complex circular or spiral wreath of long powerful, cirrose cilia, the left limb or extremity of which is spirally involute and forms the entrance to the oral fossa. This fossa is continued as a short, tubular pharynx. Anus posteriorly situated, subterminal. Cuticular cilia very fine, distributed evenly throughout, clothing both the body and the retractile pedicle. Length of lorica 80 to 150  $\mu$ . There are many species, varying greatly in the size and shape of the loricae. In the fresh-water forms the lorica is generally cylindrical. Another genus, *Tintinnidium*, varies from *Tintinnus* only in having a more mucilaginous sheath and in being permanently attached to foreign objects. (Pl. XIII, Fig. 12.)

#### **Codonella.**

Animalcules conical or trumpet-shaped, solitary, free-swimming, highly contractile, inhabiting a helmet- or bell-shaped lorica, to which they are attached by their posterior extremity. The anterior region truncate or excavate, forming a circular peristome having an outer fringe of about twenty long, tentacle-like cilia, and an inner collar-like border, or frill, which bears an equal number of slender, lappet-like appendages. Entire cuticular surface clothed with fine, vibratile cilia. Lorica not perforated, of chitinous consistence, often of a brown color, sometimes sculptured or mixed with foreign granular substances. Length of lorica 50 to 150  $\mu$ . Several species, mostly marine. (Pl. XIV, Fig. 1.)

#### **Stentor.**

Animalcules sedentary or free-swimming at will; bodies highly elastic and variable in form; when swimming and contracted, clavate, pyriform, or turbinate; when fixed and extended, trumpet-shaped, broadly expanded anteriorly, tapering off and attenuated toward the attached posterior extremity. Peristome describing an almost complete circuit around the expanded anterior border, its left-hand extremity or limb spirally involute, forming a small pocket-shaped fossa conducting to the oral aperture, the right-

hand limb free and usually raised considerably above the opposite or left-hand one. Peristomal cilia cirrose, very large and strong; cilia of the cuticular surface very fine, distributed in even longitudinal rows, occasionally supplemented by scattered hair-like setæ. Nucleus band-like, moniliform, or rounded. Contractile vesicle complex. Multiplication by oblique fission and by germs separated from the band-like endoplast. There are many species some of large size, colorless, or greenish, bluish, brownish, etc. (Pl. XIV, Fig. 2.)

### **Bursaria.**

Animalcules free-swimming, broadly ovate, somewhat flattened on one side, anteriorly truncate. Peristome-field pocket-shaped, deeply excavate, situated obliquely on the anterior half of the body, having a broad oral fossa in front, and a cleft-like lateral fissure, which extends from the left corner of the contour border to the middle of the ventral side; no tremulous flap. Pharynx long, funicular, bent toward the left, and forming a continuation of the peristome excavation. Adoral ciliary wreath broad, much concealed, lying completely within the peristome-cleft. Cuticular cilia fine, in longitudinal rows. Anus posteriorly situated, terminal. Nucleus band-like, curved, or sinuous. Contractile vesicles distinct, usually multiple. Few species. Length 300 to 500  $\mu$ . (Pl. XIV, Fig. 3.)

## **ORDER HOLOTRICHA**

Ciliata with but one sort of cilia, these covering the body uniformly and almost completely. A variously modified extensile or undulating membrane sometimes present. Oral and anal orifices usually conspicuous. Trichocysts sometimes present in the cuticular layer.

### **Paramæcium.**

Animalcules free-swimming, ovate or elongate, asymmetrical, more or less flexible, but persistent in shape. Finely ciliated throughout the cilia of the oral region not differing in size or character from those of the general surface of the body. An oblique groove developed on the ventral surface, at the posterior extremity of which is situated the oral aperture. Cortical layer usually enclosing trichocysts. Contractile vesicles and nucleus conspicuous, the former sometimes stellate. There are several species. The most important is *P. aurelia*, which is often found in sewage-polluted and stagnant water. It is colorless, has a length of about 225  $\mu$ , and moves with a brisk rotatory motion. (Pl. XIV, Fig. 4.)

**Nassula.**

Animalcules ovate, cylindrical, flexible, but not polymorphic, usually highly colored—rose, red, blue, yellow, etc. Oral aperture lateral. Pharynx armed with a simple horny tube or with a cylindrical fascicle of rod-like teeth. Entire surface of cuticle finely and evenly ciliate. The cortical layer sometimes containing trichocysts. There are several species, varying in color, shape, and size. Length 50 to 250  $\mu$ . (Pl. XIV, Fig. 5.)

**Coleps.**

Animalcules ovate, cylindrical, or barrel-shaped, persistent in shape, cuticular surface divided longitudinally and transversely by furrows into quadrangular facets; these facets are smooth and indurated, the narrow furrows soft and clothed with cilia; the anterior margin mucronate or denticulate; the posterior extremity mucronate and provided with spines or cusps. Oral aperture apical, terminal, surrounded with cilia. Anal aperture at posterior extremity. Color gray or light brown. The most common species is *C. hirtus*, which has a length of about 60  $\mu$ . (Pl. XIV, Fig. 6.)

**Enchelys.**

Animalcules free-swimming, elastic, and changeable in shape, pyriform or globose. Oral aperture situated at the termination of the narrower and usually oblique truncate anterior extremity. Anal aperture at the posterior termination. Cuticular surface finely and entirely ciliate; the cilia are longer in the region of the mouth. Few species. Length about 25 to 50  $\mu$ . (Pl. XIV, Fig. 7.)

**Trachelocerca.**

Animalcules colorless, highly elastic, and changeable in form, the anterior portion produced as a long, flexible, narrow, necklike process, the apical termination of which is separated by an annular constriction from the preceding part, and is perforated apically by the oral aperture. Cuticular surface evenly and finely ciliate; a circle of larger cilia developed around the oral region. Length of extended body about 150  $\mu$ . Few species. (Pl. XIV, Fig. 8.)

**Pleuronema.**

Animalcules ovate, colorless. Oral aperture situated in a depressed area near the center of the ventral surface, supplemented by an extensile, hood-shaped, transparent membrane or velum, which is let down or retracted at will. Numerous longer vibratile cilia stationed at the entrance of the oral cavity. The general surface of the body clothed with long, stiff, hair-like setæ. The cortical layer usually containing trichocysts. Length 60 to 100  $\mu$ . Few species. (Pl. XIV, Fig. 9.)

**Colpidium.**

Animalcules free-swimming, colorless, kidney-shaped. Entirely ciliate. Oral aperture inferior, subterminal. Pharynx supported throughout its length by an undulating membrane which projects exteriorly in a tongue-like manner. Two nuclei, rounded, sub-central. Length 50 to 100  $\mu$ . One species. (Pl. XV, Fig. 1.)

## SUB-CLASS SUCTORIA (TENTACULIFERA OR ACINETARIA)

Protozoa with neither flagellate appendages nor cilia in their adult state, but seizing their food and effecting locomotion, when unattached, by means of tentacles. These are simply adhesive or tubular and provided at their distal extremity with a cup-like sucking-disk. Nucleus usually much branched. One or more contractile vesicles. Multiplication by longitudinal or transverse fission or by external or internal bud-formation. The young forms are ciliated. Most of the Suctoria are sedentary.

**Acineta.**

Animalcules solitary, ovate or elongate, secreting a protective lorica, to the sides of which they are adherent or within which they may remain freely suspended. Lorica transparent, triangular or urn-shaped, supported upon a rigid pedicle. Tentacles suctorial, capitate, distributed irregularly or in groups. There are many species. (Pl. XV, Fig. 2.)

## REFERENCES

- BÜTSCHLI, O. 1880-2. Protozoa. In Bronn's Klassen und Ordnungen des Thier-Reichs. Leipzig und Heidelberg. 3 vols.
- CALKINS, GARY N. 1901. The Protozoa. The Macmillan Co., New York.
- CALKINS, DR. GARY N. 1901. The Protozoa. New York. The Macmillan Company. (A general biological treatise on this class of organisms.)
- CALKINS, DR. GARY N. 1909. Protozoölogy. New York. Lea & Febiger. (An introduction to the study of modern protozoölogy.) The best general description of the life history of these organisms. Little systematic material.
- CLAPARÈDE ET LACHMANN. 1858-61. Études sur les Infusories. Genève.
- CONN, H. W. 1905. A Preliminary Report on the Protozoa of the Fresh Waters of Connecticut. Bulletin No. 2 of the State Geological and Natural History Survey.
- DUJARDIN, F. 1841. Histoire Naturelle des Infusoires.
- EHRENBERG, CHR. FR. 1838. Die Infusionsthierchen als vollkommene Organismen.

- ENGELMANN, TH. W. 1862. Zur Naturgeschichte der Infusionsthier. Leipzig.
- HERTWIG, R., und LESSER, E. 1874. Ueber Rhizopoden und denselben nahe stehende Organismen. Archiv. f. Mikroskopische Anatomie. Bd. X. Supplementheft.
- KENT, W. SAVILLE. 1880-81. A Manual of the Infusoria. 3 vols. London.
- LANKESTER, E. R. Protozoa. Encyc. Brit., XIX.
- LEIDY, J. 1879. Fresh-water Rhizopods of North America. U. S. Geol. Sur. Washington.
- PRICHARD, ANDREW. 1861. A History of Infusoria, including the Desmidiaceæ and Diatomaceæ, British and Foreign. London: Whittaker & Co.
- STEIN, F. 1859-78. Der Organismus der Infusionsthier. 3 Bde.
- STOKES, A. C. 1888. A Preliminary Contribution toward a History of the Freshwater Infusoria of the U. S. Jour. of the Trenton Nat. His. Soc., I, Jan., 1888.

(See also page 393.)

## CHAPTER XXVI

### ROTIFERA

THE Rotifera, or Rotatoria, comprise a well-defined group of minute multicellular animals. They are often included among the Vermes, but some of them possess characteristics that suggest the Arthropoda.

Though microscopic in size, the Rotifera are quite highly organized. They have a well-defined digestive system, including a mouth, or buccal orifice; a mastax, a peculiar set of jaws for mastication; salivary glands; an oesophagus; gastric glands; a stomach; an intestine; and an anus. There is a vascular system, a muscular system; and, it is claimed, a nervous system. There is a conspicuous reproductive system and both males and females are observed, although the males are rare. The transparency of most of the Rotifera renders these various organs subjects of easy investigation.

The organisms are protected by a firm, homogeneous, structureless cuticle, often hardened by a development of chitin, forming a carapace or lorica. Some genera are further protected by an exterior casing or sheath, called an "urceolus," which may be gelatinous and transparent, as in *Floscularia*, or covered with foreign particles or pellets, as in *Melicerta*.

The Rotifera are generally bilaterally symmetrical, with a dorsal and ventral surface, with definite head region and tail region, broadest anteriorly and tapering posteriorly. There are three features of the Rotifera that deserve special attention, partly because they are unique in the organisms of this group and partly because they are used as the basis of classi-

fication. They are the ciliary wreath, the mastax, and the foot.

The ciliary wreath consists of one or more circlets of cilia springing from disk-like lobes surrounding the mouth at the anterior end. By their continual lashing they present the appearance of wheels, giving to these organisms the name of "wheel-animalcules." Their function is to assist in locomotion, to create currents in the water by which food-particles are carried into the mouth, and to conduct this food-material through the alimentary canal. The disk-like lobe bearing the cilia is known by the names of corona, trochal disk, or velum. It takes different shapes in different rotifers. Its simplest form is an oval or circle. In more complex forms it is intricately folded, as shown on Pl. XVI, Figs. A to E. The ciliated wreath is often supplemented by certain projecting processes, ciliated or bearing setæ or bristles.

The foot, pseudopodium, or posterior extremity of a rotifer presents several different types. It may be fleshy and transversely wrinkled, or hard and jointed; it may be non-retractile or retractile; often the jointed forms are telescopic; it may terminate in a sort of sucking-disk or in a ciliated expansion, or it may be furcate, or divided into toes, as shown on Pl. XVI, Figs. F to I. In some species the foot is altogether lacking.

The mastax is a sort of muscular bulb forming a part of the pharynx and containing the trophi. It has an opening above from the mouth and below into the œsophagus. The trophi, or teeth, are peculiar calcareous structures. Their function is to grind the food before it passes into the stomach, and this grinding movement may be witnessed through the transparent walls of many rotifers. The trophi consist of two toothed, hammer-like bodies, or mallei, that pound on a sort of split anvil, or incus. The malleus consists of an upper part, the head or uncus, and a lower part, the handle or manubrium. The incus also consists of two parts, a symmetrically divided upper part, the rami, that receives the blow of the malleus, and a lower part or fulcrum. The trophi

show great modifications in different genera in the shape and proportion of the various parts.\* Pl. XVI, Fig. J, represents a typical form.

These three characteristics—the arrangement of the ciliary wreath, the structure of the foot, and the form of the trophi—serve as the basis for dividing the Rotifera into orders and families. The following classification is that adopted by Hudson and Gosse. Only the typical and very common genera are described.

### ORDER RHIZOTA

Rotifera fixed when adult; usually inhabiting a gelatinous tube excreted from the skin. Foot transversely wrinkled, not contractile within the body, ending in an adhesive sucking-disk or cup, without telescopic joints, never furcate.

**FAMILY FLOSCULARIADÆ.**—Corona produced longitudinally into lobes bearing the setæ. Mouth central. Ciliary wreath a single half-circle above the mouth. Trophi uncinatæ.

#### **Floscularia.**

Frontal lobes short, expanded, or wholly wanting. Setæ very long and radiating, or short and cilia-like. Foot terminated by a non-retractile peduncle, ending in an adhesive disk. Inhabiting a transparent gelatinous tube into which the animal contracts

\* The following terms are used to describe the trophi (see Pl. XVI, Figs. J to P):

*Malleate.*—Mallei stout; manubria and unci of nearly equal length; unci 5- to 7-toothed; fulcrum short.

*Submalleate.*—Mallei slender; manubria about twice as large as the unci; unci 3- to 5- toothed.

*Forcipitate.*—Mallei rod-like; manubria and fulcrum long; unci pointed or evanescent; rami much developed and used as forceps.

*Incurvate.*—Mallei evanescent; rami highly developed into a curved forceps; fulcrum stout.

*Uncinate.*—Unci 2-toothed; manubria evanescent; incus slender.

*Ramate.*—Rami subquadrate, each crossed by two or three teeth; manubria evanescent; fulcrum rudimentary.

*Malleo-ramate.*—Mallei fastened by unci to rami; manubria three loops soldered to the unci; unci 3-toothed; rami large, with many striæ parallel to the teeth; fulcrum slender.

when alarmed. There are several species, varying in length from 200 to 2500  $\mu$ . (Pl. XV, Fig. 3.)

**FAMILY MELICERTADÆ.**—Corona not produced in lobes bearing setæ. Mouth lateral. Ciliary wreath a marginal continuous curve bent on itself at the dorsal surface so as to encircle the corona twice, with the mouth between its upper and lower curves, and having a dorsal gap between its points of flexure. Trophi malleo-ramate.

#### **Melicerta.**

Corona of four lobes. Dorsal gap wide. Dorsal antennæ minute. Ventral antennæ obvious. Inhabiting tubes built up of pellets. Length 800 to 1500  $\mu$ . Few species. *M. ringens* is very common on water-plants. (Pl. XV, Fig. 4.)

#### **Conochilus.**

Corona horseshoe-shaped, transverse; gap in ciliary wreath ventral. Mouth on the corona, and toward its dorsal side. Dorsal antennæ very minute or absent. Ventral antennæ obvious. Forming free-swimming clusters of several individuals, inhabiting coherent gelatinous tubes. Length 500 to 1200  $\mu$ . Two species. *C. volvox* is very common. (Pl. XV, Fig. 5.)

### **ORDER BDELLOIDA**

Rotifera that swim with their ciliary wreath and creep like a leech. Foot wholly retractile within the body, telescopic, at the end almost invariably divided into three toes.

**FAMILY PHILODINADÆ.**—Corona a pair of circular lobes transversely placed. Ciliary wreath a marginal continuous curve bent on itself at the dorsal surface so as to encircle the corona twice, with mouth between its upper and lower curves, and having also two gaps, the one dorsal between its points of flexure, the other ventral in the upper curve opposite to the mouth. Trophi ramate.

#### **Rotifer.**

Eyes two, within the frontal column. The most common species is *R. vulgaris*, which has a transparent body, smooth, and tapering to the foot. Spurs and dorsal antennæ of moderate length. Length about 500  $\mu$ . This was one of the first rotifers discovered. It gave its name to the entire class. (Pl. XV, Fig. 6.)

## ORDER PLOIMA

Rotifera that swim with their feet and (in some cases) creep with their toes. This is the largest and most important order of Rotifera.

## SUB-ORDER ILLORICATA

Integument flexible, not stiffened to an enclosing shell. Foot, when present, almost invariably furcate, but not transversely wrinkled: rarely more than feebly telescopic, and partially retractile.

**FAMILY MICROCODIDÆ.**—Corona obliquely transverse, flat, circular. Mouth central. Ciliary wreath a marginal continuous curve encircling the corona, and two curves of larger cilia, one on each side of the mouth. Trophi forcipitate. Foot stylate.

**Microcodon.**

Eye single, centrally placed, just below the corona. One species. Length about 200  $\mu$ , of which the foot is more than half. (Pl. XV, Fig. 7.)

**FAMILY ASPLANCHNADÆ.**—Corona subconical, with one or two apices. Ciliary wreath single, edging the corona. Intestine and cloaca absent.

**Asplanchna.**

Corona with two apices. Trophi incudate, not enclosed within mastax. Stomach of moderate size, spheroidal. Viviparous. Several species. Very large and transparent. (Pl. XV, Fig. 8.)

**FAMILY SYNCHÆTADÆ.**—Corona a transverse spheroidal segment, sometimes much flattened, with styliigerous prominences. Ciliary wreath a single interrupted or continuous marginal curve encircling the corona. Mastax very large, pear-shaped. Trophi forcipitate. Foot minute, furcate.

**Synchaeta.**

Form usually that of a long cone whose apex is the foot; front furnished with two ciliated club-shaped prominences. Ciliary wreath of interrupted curves. Foot minute, furcate. Several species. Length 150 to 300  $\mu$ . (Pl. XVI, Fig. 1.)

**FAMILY TRIARTHRAE.**—Body furnished with skipping appendages. Corona transverse. Ciliary wreath single, marginal. Foot absent.

**Polyarthra.**

Eye single, occipital. Mastax very large and pear-shaped. Trophi forcipitate. Provided with two clusters of six spines on the shoulders, the spines being in the form of serrated blades. Length about 125  $\mu$ . (Pl. XVI, Fig. 2.)

**Triarthra.**

Eyes two, frontal. Mastax of moderate size. Trophi malleolate. Spines single, two lateral, one ventral. There are three species, differing chiefly in the length of the spines. In the most common species the spines are twice the length of the body. Length of body about 150  $\mu$ . (Pl. XVI, Fig. 3.)

**FAMILY HYDATINAE.**—Corona truncate, with styli-gerous prominences. Ciliary wreath two parallel curves, the one marginal fringing the corona and mouth, the other lying within the first, the styli-gerous prominences lying between the two. Trophi malleate. Foot furcate.

**Hydatina.**

Body conical, tapering toward the foot. Foot short and confluent with the trunk. Eye absent. This is one of the largest of the Plöima. Length about 600  $\mu$ .

**FAMILY NOTOMMATAE.**—Corona obliquely transverse. Ciliary wreath of interrupted curves and clusters, usually with a marginal wreath surrounding the mouth. Trophi forcipitate. Foot furcate. This family is the most typical, the most highly organized, of the Rotifera.

**Diglena.**

Body subcylindrical, but very versatile in outline, often swelling behind and tapering to the head. Eyes two, minute, situated near the edge of the front. Foot furcate. Trophi forcipitate, generally protrusile. Several species. Length 125 to 400  $\mu$ . (Pl. XVI, Fig. 4.)

SUB-ORDER LORICATA

Integument stiffened to a wholly or partially enclosing shell; foot various.

**FAMILY RATTULIDAE.**—Body cylindrical or fusiform, smooth, without plicæ or angles; contained in a lorica closed all around, but open at each end, often ridged. Trophi long, asymmetrical. Eye single, cervical.

**Mastigocerca.**

Body fusiform or irregularly thick, not lunate. Toe a single style, with accessory stylets at its base. Lorica often furnished with a thin dorsal ridge. Many species. (Pl. XVI, Fig. 5.)

**FAMILY COLURIDÆ.**—Body enclosed in a lorica, usually of firm consistence, variously compressed or depressed, open at both ends, closed dorsally, usually open or wanting ventrally. Head surrounded by a chitinous arched plate or hood. Toes two, rarely one, always exposed.

**Colurus.**

Body subglobose, more or less compressed. Lorica of two lateral plates, open in front, gaping behind. Frontal hood in form of a non-retractile hook. Foot prominently extruded, of distinct joints, terminated by two furcate toes. Many species.

**FAMILY BRACHIONIDÆ.**—Lorica box-like, open at each end, generally armed with anterior and posterior spines. Foot very long, flexible, uniformly wrinkled, without articulation; toes very small.

**Brachionus.**

Lorica without elevated ridges, gibbous both dorsally and ventrally. Foot very flexible, uniformly wrinkled, without articulation; toes very small. Free-swimming. Many species. (Pl. XVII, Fig. 1.)

**Noteus.**

Lorica faceted and covered with raised points; gibbous dorsally, flat ventrally. Foot obscurely jointed. Toes moderately long. Eyes wanting. Length 350  $\mu$ .

**FAMILY ANURÆADÆ.**—Lorica box-like, broadly open in front, open behind only by a narrow slit. Usually armed with spines or elastic setæ. Foot wholly wanting.

**Anuraea.**

Lorica an oblong box, open widely in front, narrowly in rear; dorsal surface usually tessellated. The occipital ridge always, the anal sometimes, furnished with spines. The egg after extrusion is carried attached to the lorica. Free-swimming. Length about 125  $\mu$ . (Pl. XVII, Figs. 2 and 3.)

**Notholca.**

Lorica ovate, truncate and six-spined in front, sometimes produced behind; of two spoon-like plates united laterally. No posterior spines. Dorsal surface marked longitudinally with al-

ternate ridges and furrows. Expelled egg not usually carried. Free-swimming. Several species. (Pl. XVII, Fig. 4.)

### ORDER SCIRTOPODA

Rotifera swimming with their ciliary wreath and skipping with arthropodous limbs; foot absent. There is but one genus, *Pedalion*, and that is rare.

### REFERENCES

- BOURNE, A. C. 1886. Rotifera, in *Encyc. Britan.*, XXI.  
DELAGE, Y., et HÉROUARD, E. 1897. *Traité de Zoologie concrete*. Paris.  
HERRICK, C. L. 1885. Notes on American Rotifera. *Bull. Sci. Lab. Dennison University*, 43-62. Granville, Ohio.  
HUDSON and GOSSE. 1886. *The Rotifera, or Wheel-animalcules*. 2 vols. London.  
JENNINGS, H. S. 1894. The Rotatoria of the Great Lakes. *Bulletin of the Michigan Fish Commission*, No. 3.

(See also page 393.)

## CHAPTER XXVII

### CRUSTACEA

THE Crustacea belong to the Arthropoda—that is, to that group of the Articulates that have jointed appendages. Most of the larger Crustacea are marine, but many of the smaller forms are found in fresh water. These vary in size from objects barely visible to the naked eye to bodies several centimeters in length. The most common forms are somewhat less in size than the head of a pin.

The fresh-water Crustacea have been sometimes divided into two groups, the Entomostraca and the Malacostraca.

The Malacostraca are comparatively large forms. They include the Amphipoda, one of which is *Gammarus pulex*, the “water-crab”; the Isopoda, with *Asellus aquaticus*, or the “water-louse”; and the Decapoda, or ten-footed animals.

The Entomostraca may be said to include most of the smaller, free-swimming Crustacea, but the word is sometimes used in a stricter and more limited sense. The bodies of the Entomostraca are more or less distinctly jointed, and are contained in a horny, leathery, or brittle shell formed of one or more parts. The shell is composed of chitin impregnated with a variable amount of carbonate of lime. It is often transparent, and may be striated, reticulated, notched, spinous, etc. It varies in structure in different genera. It may be a bivalve, like a mussel-shell, or folded so as to give the appearance of a bivalve without being really so, or segmented, like a lobster’s shell. The body of the organism is segmented, and there is generally a cephalo-thorax region and an abdominal region. In some cases there are distinct head and tail regions. There are one or two pairs of antennæ springing from near

the head. The feet vary in number, position, and character. In some genera they are flattened and have branchiæ, or breathing-plates, attached to them, enabling them to perform the function of respiration. There is one conspicuous eye, usually black or reddish, situated in the head region. Near the mouth are two mandibles, and near them are the maxillæ, or foot-jaws, armed with spines or claws and sometimes with branchiæ. There is a heart, often square, that causes the circulation of colorless blood; and well-marked digestive, muscular, nervous, and reproductive systems. The eggs of the Entomostraca may be seen in brood-cavities inside the shell or in exterior attached egg-sacs. The young often hatch in the nauplius form, and undergo several changes before arriving at the adult condition.

The Entomostraca are usually divided into four orders—Copepoda, Ostracoda, Cladocera, and Phyllopoda. The last three are sometimes placed as sub-orders under the order Branchiopoda.

#### ORDER COPEPODA

Shell jointed, forming a more or less cylindrical buckler, or carapace, enclosing the head and thorax. The anterior part of the body is composed of ten segments more or less fused. The five constituting the head bear respectively a pair of jointed antennæ, a pair of branched antennules, a pair of mandibles, or masticatory organs, a pair of maxillæ, and a pair of foot-jaws. The five thoracic segments bear five pairs of jointed swimming-feet, the fifth often rudimentary. There are about five abdominal segments, nearly devoid of appendages, and continued posteriorly by two tail-like stylets. Young hatched in the nauplius state.

The Copepoda move by vigorous leaps. They lead a roving, predatory life and well deserve the name of "scavengers."

#### Cyclops.

Copepoda with head hardly distinguishable from the body. The thorax and abdomen generally distinguishable, the former having four and the latter six segments. Two pairs of antennæ, the superior large and many-jointed, the inferior smaller, furnished with short

setæ; both superior antennæ of the male have swollen joints. The antennæ assist in locomotion. Two pairs of vigorous branched foot-jaws. One eye, large, single, central. Two egg-sacs. Cyclops are very prolific, as many as 30 or 40 ova being laid at a time and broods occurring at short intervals. The eggs may hatch after leaving the ovary. There are many species. (Pl. XVII, Fig. 5.)

#### **Diaptomus.**

Copepoda resembling Cyclops in their general appearance. Thorax and abdomen each five-segmented. Antennæ very long, many-jointed, with setæ; the right antenna only swollen in the male. Antennules large, bifid, the two unequal branches arising from a common footstalk. Three pairs of unbranched foot-jaws. One egg-sac. The ova hatch while borne by the female. (Pl. XVII, Fig. 6.)

#### **Canthocamptus.**

Copepoda somewhat resembling Cyclops. The ten segments of the thorax and abdomen not distinguishable. The segments decrease in size as they descend. At the junction of the fourth and fifth segments the body is very movable. Antennæ very short. Five pairs of swimming-feet, much longer than in cyclops. One egg-sac. (Pl. XVII, Fig. 7.)

### **ORDER OSTRACODA**

Shell consisting of two valves, entirely enclosing the body; from one to three pairs of feet; no external ovary.

#### **Cypris.**

Body enclosed within a horny bivalve shell, oval or reniform. Superior antennæ seven-jointed, with long feathery filaments arising from the last three. Inferior antennæ leg-like, with claws and setæ at the end. Two pairs of feet. Eye single. Color greenish, brownish, or whitish. A large number of species. The shell is seldom open wide. (Pl. XVII, Fig. 8.)

### **ORDER CLADOCERA**

Shell consisting of two thin chitinous plates springing from the maxillary segment. The most important characteristic is the presence of several pairs of leaf-like feet provided with branchiæ, or breathing-organs. There is a large single eye.

Two pairs of antennæ, large, branched, and adapted for swimming. This order contains a number of common genera.

**Daphnia.**

Head produced into a prominent beak; valves of the carapace oval, reticulated, and terminated below by a serrated spine. Superior antennæ situated beneath the beak, one-jointed or as a minute tubercle with a tuft of setæ. Inferior antennæ large and powerful, two-branched, one branch three-jointed, the other four-jointed. Five pairs of legs. Heart a colorless organ at the back of the head. Eye spherical, with numerous lenses. Ova carried in a cavity between the back of the animal and the shell. At certain seasons "winter eggs" are produced. *Daphnia* move with a louse-like, skipping movement. They are sometimes called "arborescent water-fleas." There are numerous species. (Pl. XVII, Fig. 9.)

**Bosmina.**

Head terminated in front by a sharp beak directed forward and downward, and from the end of which project the long, many-jointed, curved, and cylindrical superior antennæ. Inferior antennæ two-branched, one branch three-, the other four-jointed. Five pairs of legs. Shell oval, with a spine at the lower angle of the posterior border. Eye large. Eggs hatched in a brood-cavity at the back of the shell. (Pl. XVII, Fig. 10.)

**Sida.**

Shell long and narrow. Head separated from the body by a depression. Posterior margin nearly straight. No spine or tooth. Antennæ large, one two-jointed, one three-jointed. Six pairs of legs. (Pl. XVIII, Fig. 1.)

**Chydorus.**

Shell nearly spherical; beak long and sharp, curved downward and forward. Antennæ short. Eye single. Color greenish or dark reddish. Moves with an unsteady rolling motion. (Pl. XVIII, Fig. 2.)

### ORDER PHYLOPODA

Body with or without a shell. Legs 11 to 60 pairs; joints foliaceous or branchiform, chiefly adapted for respiration and not motion. Two or more eyes. One or two pairs of antennæ, neither adapted for swimming.

**Branchipus.**

Body without a shell. Legs eleven pairs. Antennæ two pairs, the inferior horn-like and with prehensile appendages in the male.

Tail formed of two plates. Cephalic horns, with fan-shaped appendages at the base. Color reddish. Floats slowly on its back. (Pl. XVIII, Fig. 3.)

## REFERENCES

- FORDYCE, Charles. The Cladocera of Nebraska. Studies from the Zoological Laboratory, the University of Nebraska, under the direction of Henry B. Ward, No. 42.
- HERRICK, C. L. A Final Report on the Crustacea of Minnesota, included in the orders Cladocera and Copepoda. From the Annual Report of Progress for 1883 of the Geol. and Nat. Hist. Survey of Minnesota.
- JUDAY, CHANCEY. 1904. The Diurnal Movement of Plankton Crustacea. Transactions of the Wisconsin Acad. of Sciences, Arts and Letters. Vol. XIV, Aug., 1904.
- MARSH, C. DWIGHT. On the Cyclopidæ and Calanidæ of Lake St. Clair. Bulletin No. 5 of the Michigan Fish Commission.
- MARSH, C. DWIGHT. On the Deep-water Crustacea of Green Lake. Wis. Acad. Sci. Arts and Letters, VIII, 211-213.
- BAIRD, W. 1850. The Natural History of the British Entomostraca. London: Ray Society.
- BIRGE, E. A. 1881. Notes on the Crustacea in Chicago Water Supply, with Remarks on the Formation of the Carapace. Chic. Med. Journal and Examiner, XIV, 584-590. Chicago.

(See also page 393.)

## CHAPTER XXVIII

### BRYOZOA, OR POLYZOA

THE Bryozoa, or Polyzoa, are minute animals forming moss-like or coral-like calcareous or chitinous aggregations. The colonies are called corms, polyzoaria, or cœnœcia. They often attain an enormous size. In the adult stage they lead a sedentary life attached to some submerged object. The animals themselves are small, but easily visible to the naked eye. Some of them are covered with a secreted coating, or sheath, that takes the form of a narrow, brown-colored tube; others are embedded in a mass of jelly. The genera that live in the brown, horny tubes form tree-like growths that often attain considerable length. The branches are sometimes an inch long, and each one is the home of an individual polyzoon, or polypid. The branches, or hollow twigs, are separated from the main stalk by partitions, so that, to a certain extent, each polypid lives a separate existence in its own little case, though each was formed from its next lower neighbor by a process of budding.

The body of the organism is a transparent membranous sac, immersed in the jelly or concealed in the brown opaque sheath. It contains a U-shaped alimentary canal, with a contractile œsophagus, a stomach, and an intestine; a muscular system that permits some motion within the case, and that enables the animal to protrude itself from the case and to extend and contract its tentacles; mesenteries in the form of fibrous bands; an ovary; and a rudimentary nervous system. There is no heart and no blood-vessels of any kind.

The most conspicuous part of the animal is the circlet of ciliated tentacles. They are mounted on a sort of platform,

or disk, called a lophophore, at the forward end of the body. This lophophore, with its crown of tentacles, may be protruded from the end of the protective tube at the will of the animal. The tentacles themselves may be expanded, giving a beautiful bell-shaped, flower-like appearance. They are hollow and are covered with fine hair-like cilia. They are muscular and can be bent and straightened at will. By their combined action currents in the water are set up toward the mouth, situated just beneath the lophophore. Minute organisms are thus swept in as food.

The Bryozoa increase by a process of budding which gives rise to the branched stalks. There is also a sexual reproduction. Statoblasts, or winter eggs, form within the body and escape after the death of the animal. They are sometimes formed in such abundance as to form patches of scum upon the surface of a pond. The various forms of these statoblasts assist in the classification of the Bryozoa.

The following are some of the important fresh-water genera. There are many marine forms.

#### **Plumatella.**

Zoary confervoid, brown-colored, branched, tubular, branches distinct. Lophophore crescent-shaped. Tentacles numerous, arranged in a double row. Statoblasts elliptical, with a cellular dark-brown annulus, but no spines. (Pl. XVIII, Fig. 6.)

#### **Fredericella.**

Zoary tubular, branched, brown-colored. Lophophore circular. Tentacles about 24, arranged in a single row. Statoblasts elliptical or subspherical, smooth, no spines, without a cellular annulus. (Pl. XVIII, Fig. 4.)

#### **Paludicella.**

Zoary tubular, diffusely branched, having the appearance of brown club-shaped cells joined end to end; apertures lateral, near the broad ends of the cells. Lophophore circular. Tentacles sixteen, arranged in a single row. Statoblasts elliptical, without spines, with a cellular bluish-purple annulus. (Pl. XVIII, Fig. 5.)

#### **Pectinatella.**

Zoary massive, gelatinous, fixed. Polypids protruding from orifices arranged irregularly upon the surface. Tentacles numerous. Sta-

toblasts circular, with a single row of double hooks, not forked at the tips, as in *Cristatella*. Common. (Pl. XVIII, Fig. 7.)

### **Cristatella.**

Zoary a mass of jelly, the polypids arranged on the outside, and the tentacles extended beyond the surface. The jelly-mass is usually long and narrow and has the power of moving slowly, creeping over submerged objects. Tentacles numerous, pectinate upon two arms. Statoblasts circular, with two rows of double hooks having forked tips. Rare.

### REFERENCES

- ALLMAN, G. J. 1856. *The Fresh-water Polyzoa*. Fol. London: Ray Society.  
DAVENPORT, C. B. 1890. *Cristatella: The Origin and Development of the Individual in the Colony*. Bull. Mus. Comp. Zool. Harvard College, XX.  
HYATT, A. 1866-1868. *Observations on Polyzoa*. Proc. Essex Inst., IV and V, Salem.  
LANKESTER, E. R. Polyzoa, in *Encyc. Brit.*  
WESTON, ROBERT SPURR. 1898. *The Occurrence of Cristatella in the Storage Reservoir at Henderson, N. C.* Jour. N. E. W. W. Assoc., XIII, Sept., 1898.

(See also page 393.)

## CHAPTER XXIX

### SPONGIDÆ

THE fresh-water sponges are not of sufficient importance in water-supplies to warrant an extended description in this work. They differ materially from the marine sponges, which make up by far the greater part of the Spongidæ.

The fresh-water sponge is an agglomeration of animal cells into a gelatinous mass, often referred to as the "sarcodæ." Embedded in the sarcodæ and supporting it are minute siliceous needles, or spicules. These skeleton spicules interlace and give the sponge-mass a certain amount of rigidity. The sponge grows as flat patches upon the sides of water-pipes and conduits and upon submerged objects in ponds and streams; or it extends outward in large masses or in finger-like processes that sometimes branch. Its color when exposed to the light is greenish or brownish, but in the dark places of a water-supply system its color is much lighter and is sometimes creamy white. The sponge feeds upon the microscopic organisms in water, which are drawn in through an elaborate system of pores and canals. If these pores become choked up with silt and amorphous matter the organism dies. For this reason sponge-patches are more abundant upon the top and sides of a conduit than upon the bottom.

At certain seasons the fresh-water sponges contain seed-like bodies known under the various names of gemmules, ovaria, statoblasts, statospheres, winter-buds, etc. They are nearly spherical and are about 0.5 mm. in diameter. They have a chitinous coat that encloses a compact mass of protoplasmic globules. In this coat there is a circular orifice, known as the foraminal aperture, through which the protoplasmic bodies make their exit at time of germination. In most species

the chitinous coat is surrounded by a "crust" in which are embedded minute spicules, called the "gemmule spicules," to distinguish them from the "skeleton spicules," referred to above. There is a third kind of spicule known as the "dermal spicule" or the "flesh spicule." They lie upon the outer lining of the canals in the deeper portions of the sponge. They are smaller than the skeleton spicules and are not bound together. Dermal spicules are not found in all species.

The skeleton spicules differ somewhat in different species. They have a length of about  $250 \mu$ . They are usually arcuate and pointed at the ends. They may be smooth or covered with spines (Pl. XVIII, Figs. 9). These skeleton spicules of sponge are commonly observed in the microscopical examination of surface-waters. The gemmule spicules differ in character in different genera and species. Their characteristics are used therefore in classifying the fresh-water sponges.

Potts has described a number of different genera of fresh-water Spongidae, among which are *Spongilla*, *Meyenia*, *Heteromeyenia*, *Tubella*, *Parmula*, *Carterius*, etc. The first two are the most important. They are sometimes given the rank of sub-families.

The *Spongilla* is a green, branching sponge. The skeleton spicules are smooth and fasciculated. The dermal spicules are fusiform, pointed, and entirely spined. The gemmule spicules are cylindrical, more or less curved, and sparsely spined—the spines often recurved. (Pl. XVIII, Fig. 8.)

The *Meyenia* are usually sessile and massive. The skeleton spicules are fusiform-acerate, abruptly pointed, coarsely spined except near the extremities; spines subconical, acute. The dermal spicules are generally absent. The gemmule spicules are irregular, birotulate, with rotules produced.

#### REFERENCES

- BOWERBANK, J. S. 1863. Monograph of the Spongillidae. Proc. Zool. Soc. London.  
BOWERBANK, J. S. 1864-1874. On the British Spongiadae. 3 vols. London: Ray Soc.

- KELLICOTT, D. S. 1891. The Mills Collection of Fresh-water Sponges. Bull. Buffalo Soc. Nat. Sc., V, 99-104.
- POTTS, E. 1880. Fresh-water Sponges of Fairmount Park. Proc. Acad. Nat. Sci., Philadelphia, 330, 331.
- POTTS, E. 1880. On Fresh-water Sponges. Proc. Acad. Nat. Sci., Philadelphia. 356, 357.
- POTTS, E. 1883. Our Fresh-water Sponges. American Naturalist, 1293-1296.
- POTTS, E. 1887. Contributions toward a Synopsis of the American Forms of Fresh-water Sponges, with Descriptions of those named by other authors and from all parts of the world. Proc. Acad. Nat. Sci., Philadelphia, p. 158-279.

(See also page 393.)

## CHAPTER XXX

### MISCELLANEOUS ORGANISMS

THE miscellaneous higher animals and plants that one is likely to observe in a microscopical examination of drinking water are so varied, and they are of such little practical importance in the interpretation of an analysis, that their description here is not warranted. It is sufficient to mention the names of a few common forms.

Of the Vermes the following may be noted: *Anguillula*, a small, colorless thread-worm like the vinegar-eel (Pl. XIX, Fig. 1); *Gordius*, the common hair-snake; *Nais*, an annulate worm with bristles (Pl. XIX, Fig. 2); *Tubifex*, another bristle-bearing worm; *Chætonotus*, an elongated worm-like organism with scales on its back (Pl. XIX, Fig. 3). Of the Arachnida: *Macrobiotus*, the water-bear (Pl. XIX, Fig. 4); and the Acarina, water-mites, or water-spiders (Pl. XIX, Fig. 5). Of the Hydrozoa: the *Hydra*, a most interesting organism from a zoological standpoint (Pl. XIX, Fig. 6). Insect larvæ; *Corethra*, or the phantom larva; scales and fragments of insects; barbs of feathers; epithelium-cells; ova of the Entozoa, Crustacea, Rotifera, etc.

Of the vegetable kingdom may be mentioned *Batrachospermum* (Pl. XIX, Fig. 7); fragments of *Sphagnum* Moss; *Myriophyllum*, or water-milfoil; *Ceratophyllum*, or hornwort (Pl. XIX, Fig. 10); *Lemna*, or duck-weed (Pl. XIX, Fig. 12); *Potamogeton*, or pond-weed (Pl. XIX, Fig. 11); *Hippuris*, or mare's-tail; *Anacharis*, or American water-weed (Pl. XIX, Fig. 9); *Utricularia*, an insectivorous plant; pollen-grains; plant-hairs; fragments of vegetable fibers and tissue; fibers of cotton, wool, silk, hemp, etc.; starch-grains, etc.

For the description of all these miscellaneous organisms and objects the reader is referred to more comprehensive books on zoology, botany, and general microscopy, and especially to "Fresh Water Biology," edited by Dr. Henry B. Ward and George C. Whipple.



## GLOSSARY TO PART II

---

- ADORAL, relating to the mouth.  
AERUGINOUS, of the color of verdigris; blue-green.  
ALATE, winged.  
AMYLACEOUS, resembling starch.  
ANAL, relating to the anus.  
ANNULATE, marked with rings.  
ANTHERIDIA, reproductive organs supposed to be analogous to anthers.  
ARCUATE, bent like a knee.  
ARTICULATE, composed of joints.  
BACILLAR, rod-like.  
BIFID, two-cleft.  
BIROTULATE, with two recurved rounded ends.  
BOTRYOID, clustered like a bunch of grapes.  
BUCCAL, relating to the cheek.  
CAMPANULATE, bell-shaped.  
CAPITATE, collected in a head.  
CARAPACE, a hard shell.  
CARINATE, like a keel.  
CAUDAL, relating to the tail.  
CERVICAL, relating to the neck.  
CHITINOUS, horny.  
CILIATED, provided with cilia, or hair-like appendages.  
CIRCINATE, curled round, coiled, or spirally rolled up.  
CIRROSE, curled as a tendril.  
CLATHRATE, perforated or latticed like a window.  
COCCUS, a minute spherical form.  
CŒNOBIUM, a community of a definite number of individuals united in one body.  
CONCATENATE, linked like a chain.  
CONNATE, united congenitally.  
CONVOLUTE, rolled together.

- CORTICAL, relating to the external layers.
- CRENATE, notched or scalloped.
- CUNEATE, wedge-shaped.
- CYMBIFORM, boat-shaped.
- CYST, a membranous sac without opening.
- DENTATE, toothed.
- DENTICULATE, finely toothed.
- DICHOTOMOUS, dividing by pairs from top to bottom.
- DIOECIOUS, the males and females represented in separate individuals.
- ECTODERM, the external of two germinal cellular layers.
- EMARGINATE, with a notch cut out of the margin at the end.
- ENCUIRASSED, with an indurated dorsal shield.
- ENCYSTED, enclosed in a cyst or bladder.
- ENDOCHROME, the coloring matter of cells.
- ENDOPLAST, the nucleus of a protozoan cell.
- FASCICULATE, in bundles from a common point.
- FILIFORM, long, slender, thread-like.
- FLAGELLATE, provided with flagella, or lash-like appendages.
- FOLIACEOUS, resembling a leaf.
- FORCIPITATE, like forceps.
- FUNICULAR, like a cord or thread.
- FURCATE, forked or divergently branched.
- FUSIFORM, tapering like a spindle.
- GIBBOUS, swollen, convex.
- GONIDIA, propagative bodies of small size not produced by act of fertilization.
- HETEROCYST, interspersed cells of a special character differing from their neighbors.
- HOLOPHYTIC, like a plant.
- HORMOGONS, special reproductive bodies composed of short chains of cells, parts of internal filaments.
- HYALINE, transparent.
- HYPHAE, filaments of the vegetative portion of a fungus.
- INDURATED, hardened.
- INTERCALATED, interspersed, placed between others.
- INVOLUTE, rolled inward.
- LAMELLATED, lamellose, in layers.
- LANCEOLATE, lance-shaped, tapering at each end.
- LENTICULAR, like a lens.
- LOPHOPHORE, an organ bearing tentacles, found on the Bryozoa.
- LORICA, a hard protective coat.
- LUNATE, crescent-shaped.
- MACROGONIDIA, large gonidia.
- MACROSPORES, large spores.

- MATRIX, the birth cavity.
- MICROGONIDIA, small gonidia.
- MONAXONIC, with but one axis.
- MONILIFORM, like a necklace, contracted at regular intervals.
- MONŒCIOUS, male and female represented in one individual.
- MUCRONATE, having a small tip.
- MYCELIUM, the vegetative portion of a fungus.
- NAVICULOID, boat-shaped.
- OOSPHERE, an ovarian sac.
- OOSPORE, spore produced in an ovarian sac.
- ORAL, relating to the mouth.
- PARIETAL, growing near the wall.
- PERISTOME, the oral region.
- PINNATIFID, shaped like a feather.
- POLYTHECIUM, an assemblage of many loricae.
- PUNCTATE, studded with points or dots.
- PYRIFORM, pear-shaped.
- RENIFORM, kidney-shaped.
- REPLICATE, folded back.
- RETICULATE, latticed.
- RETRACTILE, capable of being drawn back.
- SACCATE, like a bag.
- SARCODE, the primary vital matter of animal cells (Protoplasm).
- SCALARIFORM, ladder-like.
- SEGREGATE, set apart from others.
- SEPTATE, separated by partitions.
- SETIFORM, in the form of a bristle.
- SIGMOIDAL, S-shaped.
- SINUATE, with notches or depressions.
- SPERMATIZOIDS, thread-like bodies, motile, and possessing fecundative power.
- SPORANGIUM, sporange, a spore-case.
- SPOROCARP, the covering or capsule enclosing a spore.
- SPORODERM, the covering of a spore.
- STATOBLASTS, the winter eggs, or reproductive bodies of the Bryozoa and Spongiadæ.
- STRIATE, covered with striæ.
- STYLIGEROUS, bearing styles or prominences.
- SUB- a prefix indicating "almost," or "nearly."
- SUBORBICULAR, almost spherical.
- THALLUS, a leaf-like expansion.
- TRICHOCYST, a rod-like body developed in the cortical layer of some protozoa.
- TRICHOME, the thread or filament of filamentous algæ.

TURBINATE, shaped like a top.

UTRICULATE, inflated.

VACUOLATED, containing drops or vacuoles.

VESICULIFORM, bladder-like.

ZOODENDRUM, a bill-like colony-stalk.

ZOOGONIDIA, gonidia endowed with motion.

ZOOSPORES, locomotive spores.

ZYGOSPORE, a spore resulting from conjugation.

## TABLES AND FORMULÆ

---

### WEIGHTS AND MEASURES—CONVERSION TABLES

- 1 lb. Avoir. = 1.215 lbs. Troy or Apoth. = 7000 grains Troy = 453.6 grams.  
 1 lb Troy or Apoth. = .823 lb. Avoir. = 5760 grains Troy = 373.2 grams.  
 1 oz. Avoir. = .960 fluid ounce = 28.35 grams.  
 1 oz. Troy or Apoth. = 1.053 fluid ounces = 31.10 grams.  
 1 grain Troy = .0648 gram.  
 1 kilogram = 2.205 lbs. Avoir. = 2.679 lbs. Troy or Apoth.  
 1 gram = .035 oz. Avoir. = .032 oz. Troy or Apoth. = 15.432 grains Troy.  
 1 milligram = .0154 grain Troy.  
 1 Imperial gallon = 1.201 U. S. fluid gallons = 277.4 cubic inches = 4546 cubic centimeters.  
 1 U. S. fluid gallon = .833 Imperial gallon = 231 cubic inches = 3785 cubic centimeters.  
 1 U. S. fluid gallon = 8.332 lbs. Avoir. = 10.127 lbs. Troy or Apoth.  
 1 fluid ounce = 1.042 oz. Avoir. = .949 oz. Troy or Apoth. = 29.57 cubic centimeters.  
 1 liter = .264 U. S. fluid gallon = .220 Imperial gallon = 21.028 cubic inches.  
 1 liter = 33.82 fluid ounces = 2.205 lbs. Avoir. = 2.679 lbs. Troy or Apoth.  
 1 cubic centimeter = .033 fluid ounce = .035 oz. Avoir. = .032 oz. Troy or Apoth.  
 1 inch = 2.54 centimeters = 25.4 millimeters.  
 1 foot = 30.48 centimeters.  
 1 yard = 91.44 centimeters = .9144 meter.  
 1 meter = 1.0936 yards = 3.28 feet = 39 37 inches.  
 1 centimeter = .3937 inch.  
 1 millimeter = .0394 inch = .442 Paris line.  
 1 micron ( $\mu$ ) = .001 millimeter =  $\frac{1}{254000}$  inch = .000039 inch = .0004 Paris line.  
 1 Paris line = .089 inch = 2.26 millimeters = 2260.6 microns.  
 1 cubic yard = .7645 cubic meter.  
 1 cubic foot = .0283 cubic meter = 7.481 U. S. gallons = 6.232 Imperial gallons.  
 1 cubic inch = 16.39 cubic centimeters.  
 1 cubic meter = 35.216 cubic feet = 1.308 cubic yards.  
 1 cubic centimeter = .061 cubic inch.

TABLE FOR TRANSFORMING MICROMILLIMETERS (MICRONS) TO INCHES.

Microns.	Decimals of an Inch.	Fractions of an Inch.	Microns.	Decimals of an Inch.	Fractions of an Inch.
1	.000039	1/25000	25	.000984	1/1000
2	.000079	1/12500	30	.001181	1/833
3	.000118	1/8333	35	.001378	1/714
4	.000157	1/6250	40	.001575	1/625
5	.000197	1/5000	45	.001772	1/533
6	.000236	1/4333	50	.001969	1/500
7	.000276	1/3285	60	.002362	1/416
8	.000315	1/3125	70	.002756	1/357
9	.000354	1/2777	80	.003150	1/312
10	.000394	1/2500	90	.003543	1/277
15	.000591	1/1666	100	.003937	1/250
20	.000787	1/1250			

TABLE FOR TRANSFORMING CENTIGRADE TO FAHRENHEIT DEGREES OF TEMPERATURE.

Centigrade.	Fahrenheit.	Centigrade.	Fahrenheit.	Centigrade.	Fahrenheit.
-17.7	0	4.0	39.2	23.8	75.0
-15.0	5.0	4.4	40.0	25.0	77.0
-12.2	10.0	5.0	41.0	26.6	80.0
-10.0	14.0	7.2	45.0	29.4	85.0
-9.4	15.0	10.0	50.0	30.0	86.0
-6.6	20.0	12.7	55.0	32.2	90.0
-5.0	23.0	15.0	59.0	35.0	95.0
-3.8	25.0	15.5	60.0	37.7	100.0
-1.1	30.0	18.3	65.0	40.0	104.0
0	32.0	20.0	68.0		
1.6	35.0	21.1	70.0		

TABLE FOR TRANSFORMING STATEMENTS OF CHEMICAL COMPOSITION.

	Grains per U. S. Gallon.	Grains per Imp. Gallon.	Parts per 100,000.	Parts per 1,000,000.
1 grain per U. S. gallon . . . . .	1.	1.20	1.71	17.1
1 grain per Imperial gallon . . . . .	0.830	1.	1.43	14.3
1 part per 100,000 . . . . .	0.585	0.70	1.	10.0
1 part per 1,000,000 . . . . .	0.058	0.07	0.10	1.

## SCIENTIFIC LITERATURE

---

The scientific literature of fresh water micrology has become so voluminous in recent years, that no attempt has been made to make even an approximately complete list of references. The titles given below have been selected for the use of students who are interested in the history of the subject, and for this reason they have been arranged chronologically.

The titles for the later years refer more to the practical developments of the subject than to laboratory methods and descriptions of organisms.

Other references relating to particular classes of organisms are given at the end of the various chapters in Part II.

### REFERENCES

- HASSALL, A. H. 1850. A Microscopic Examination of the Water Supplied to the Inhabitants of London and the Suburban Districts. London.
- HORSFORD, E. N., and JACKSON, Chas. T. 1854. Report on the Disagreeable Tastes and Odors in the Cochituate Water Supply. Ann. Rept. Coch. Water Bd., 1854.
- BELL, JAMES. 1871. Microscopical Examination of Water for Domestic Use. Mo. Micro. Jour., V, 163. London.
- FARLOW, W. G. 1876. Reports on Peculiar Condition of the Water Supplied to the City of Boston. Report of the Cochituate Water Board, 1876.
- FARLOW, W. G. 1877. Reports on Matters connected with the Boston Water Supply. Bulletin of Bussey Inst., Jan., 1877.
- HIRT, L. 1879. Ueber den Principien und die Methode der Mikroskopischen Untersuchung des Wassers. Zeitschrift für Biologie.
- FARLOW, W. G. 1880. On Some Impurities of Drinking Water Caused by Vegetable Growths. Supplement to 1st Ann. Rept. Mass. St. Bd. of Health. Boston, 1880.

- FTELEY, A. 1880. *Algæ in a Water Supply. Settlement to 1st Ann. Rept. of Mass. St. Bd. of Health, Lunacy, and Charity.*
- NICHOLS, WM. RIPLEY. 1880. *On the Temperature of Fresh Water Lakes and Ponds. Proc. Bost. Soc. Nat. Hist., XXI.* [Contains a bibliography of the subject to date.]
- REMSEN, IRA. 1881. *On the Impurity of the Water Supply. (Odor caused by Spongilla.) Boston.*
- HYATT, J. D. 1882. *Sporadic Growth of Certain Diatoms and the Relation thereof to Impurities in the Water Supply of Cities. Proc. Am. Soc. Microscopy, 197-199, 1882.*
- FARLOW, W. G. 1883. *Relations of Certain Forms of Algæ to Disagreeable Tastes and Odors. Science, II, 333.*
- MACDONALD, J. D. 1883. *A Guide to the Microscopical Examination of Drinking Water. 2d edition. London: J. & A. Churchill.*
- POTTS, E. 1884. *Fresh-water Sponges as Improbable Causes of the Pollution of River Water. Proc. Ac. Nat. Sc., Phila., 1884, 30.*
- SMITH, HAMILTON. 1884. *Temperature of Lakes. Trans. Am. Soc. Civ. Eng., March, 1884.*
- SORBY, H. C. 1884. *Microscopical Examination of Water for Organic Impurities. Jour. Roy. Micro. Sci., Series 2, IV, 1884.*
- SORBY, H. C. 1884. *Report of Microscopical Investigation of Sewage in Thames Water Supply. Report of Royal Commission on Metropolitan Sewage Discharge, II.*
- TAYLOR, J. E. 1884. *The Aquarium: Its Inhabitants, Structure, and Management. London: W. H. Allen & Co.,*
- RAFTER, GEORGE W. 1886. *On the Use of the Microscope in Determining the Sanitary Value of Potable Water, with Special Reference to the Study of the Biology of the Water of Hemlock Lake. Proc. Micro. Sect. Rochester Acad. of Sciences, 1886.*
- HENSEN, V. 1887. *Ueber die Bestimmung des Planktons oder des im Meere, treibenden Materials an Pflanzen und Thieren. V. Bericht d. Kommission zur wiss. Untersuchung d. deutschen Meere zu Kiel, XII-XIV, 1-107.*
- HITCHCOCK, R. 1887. *The Biological Examination of Water. Am. Mo. Micr. Jour., VIII, 9.*
- NICHOLS, WM. RIPLEY. 1883. *Water Supply Considered Mainly from a Chemical and Sanitary Standpoint. New York: John Wiley & Sons, 1883.*
- RAFTER, G. W. 1888. *On the Micro-Organisms in Hemlock Water. Rochester.*
- RAFTER, GEORGE W. 1888. *The Microscopical Examination of Potable Water. No. 103 in Van Nostrand Science Series.*
- RAFTER, G. W. 1888. *Some of the Minute Animals which Assist the Self-Purification of Running Streams. Discussion of a paper by Chas. G. Carrier on the Self-Purification of Flowing Water and the Influence of Polluted Water in the Causation of Disease. Trans. A. S. C. E., XXIV, Feb., 1891.*
- SEDGWICK, WILLIAM T. 1888. *Biological Examination of Water, Technology Quarterly, II, 67, 1888.*
- CONN, H. W. *Report on Uroglena in Middletown, Conn., in 24th Ann. Rept. of Middletown Water Commissioners for year ending Dec. 31, 1889. Also paper by Prof. Williston.*

- SEDGWICK, WILLIAM T. 1889. Recent Progress in Biological Water Analysis. *Jour. N. E. W. W. Assoc.*, IV, Sept., 1889.
- RAFTER, G. W. 1889. On the Fresh-water Algæ and their Relation to the Purity of Public Water Supplies, with discussion. *Trans. Am. Soc. of Civil Eng.*, Dec., 1889.
- RAFTER, G. W., MALLORY, M. L., and LANE, J. EDW. 1889. *Volvox globator* as the cause of the fishy taste and odor of the Hemlock Lake Water in 1888. *Ann. Rept. of Ex. Bd. of Rochester, N. Y.*, for 2 years ending April 1, 1889.
- FORBES, F. F. 1890. A Study of Algæ Growths in Reservoirs and Ponds. *Journal of the N. E. Water Works Assoc.*, IV, June, 1890. Reprinted in *Fire and Water*, July 19, 1890.
- MASS. STATE BOARD OF HEALTH. 1890. Annual Reports.  
The annual reports since 1890 contain reports upon the examination of water-supplies and experiments on the filtration of sewage and water, besides the following papers:
1890. Suggestion as to the Selection of Sources of Water Supply. By F. P. Stearns.
1891. On the Amount of Dissolved Oxygen contained in Waters of Ponds and Reservoirs at Different Depths. T. M. Drown.
1891. The Effect of Aeration of Natural Waters. T. M. Drown.
1892. On the Amount of Dissolved Oxygen in the Water of Ponds and Reservoirs at Different Depths in Winter, under the Ice. T. M. Drown.
1893. On the Amount and Character of Organic Matter in Soils, and its Bearing on the Storage of Water in Reservoirs. T. M. Drown.
1901. A Study of odors observed in the Drinking Waters of Massachusetts. Gary N. Calkins.
1901. Seasonal Distribution of Microscopic Organisms in Surface Waters. Gary N. Calkins.
1901. Experimental Filtration of the Water Supply of Springfield, at Ludlow.
- PARKER, G. H. 1890. Report on the Organisms, excepting the Bacteria, found in the Waters of the State, June, 1887—July, 1889. *Mass. State Board of Health. Special Rept. on Examination of Water Supplies.* Boston.
- RAFTER, GEORGE W. 1890. The Biological Examination of Potable Water. *Proc. Rochester Acad. Sciences*, I, 33-44, 1890. Rochester.
- STEARNS, FREDERICK P. 1890. Temperature of Water. *Special Report of Mass. St. Bd. of Health on Examination of Water Supplies*, 1890, 659.
- CALKINS, GARY N. 1891. The Microscopical Examination of Water. 23d *An. Rep. Mass. St. Bd. of Health.*
- CONNECTICUT STATE BOARD OF HEALTH REPORTS for 1891 *et seq.*, contain results of monthly analyses of the water-supplies of the State.
- FORBES, F. F. 1891. The Relative Taste and Odor Imparted to Water by some Algæ and Infusoria. *Jour. of the N. E. Water Works Assoc.*, VI, June, 1891.
- LE CONTE, L. J. 1891. Some Facts and Conclusions bearing upon the Relations Existing between Vegetable and Animal Growths and Offensive Tastes and Odors in Certain Water Supplies. *Proc. Am. Water Works Assoc.*
- BOSTON WATER WORKS. ANNUAL REPORTS. 1892 *et seq.* Each report contains a summary of the work of the biological laboratory, with tables of temperature, color, micro-organisms, rainfall, etc.

1892. Temperature Curves for Lake Cochituate. Reference to the Standard Unit. Odor caused by *Synura*.

1893. Reference to Standard Unit. Note on the color of the water. Description of *Synura* and its effect on the water. Description of new colorimeter. An investigation of the cause of the color of natural water.

1894. An account of stagnation phenomena in Lake Cochituate. Note on the seasonal distribution of the Diatomaceæ and Infusoria. A key to the Infusoria found in the Boston water-supply. The bleaching effect of sunlight on the coloring matter of water.

1895. The effect of light on the growth of diatoms.

FOREL, DR. F. A. 1892, 1895, 1904. *Le Lemane*, Monographie Limnologique. 3 vols. Lausanne, F. Rouge. (Perhaps the most comprehensive book on the general subject of limnology. Although not recent it will always remain of great historical value.)

RAFTER, G. W. 1892. Some of the Circumstances affecting the Quality of a Water Supply. *Proc. Am. Water Works Assoc.*, 12th Ann. Meeting, 1892.

GARRETT, J. H. 1893. The Spontaneous Pollution of Reservoirs. (Odor produced by *Chara*.) *Lancet*, Jan. 7, 1893.

PECK, JAMES I. 1893. On the Food of the Menhaden. *Bull. U. S. Fish Com.*, XIII.

RAFTER, GEORGE W. 1893. On Some Recent Advances in Water Analysis and the Use of the Microscope for the Detection of Sewage Contamination. *Am. Month. Micro. Jour.*, May, 1893.

WHIPPLE, GEO. C. 1894. A Standard Unit of Size for Micro-Organisms. *Am. Monthly Micro. Jour.*, XV, Dec., 1894.

WHIPPLE, GEO. C. 1894. Some Observations on the Temperature of Surface Waters, and the Effect of Temperature on the Growth of Micro-organisms. *Jour. N. E. W. W. Assoc.* IX.

BIRGE, E. A. 1895. Plankton Studies on Lake Mendota. I. The vertical distribution of the pelagic crustacea. *Trans. Wisconsin Acad. of Sci., Arts, and Letters*, X, June, 1895.

FITZGERALD, DESMOND. 1895. The Temperature of Lakes. *Trans. Am. Soc. Civ. Eng.*, XXXIV, Aug., 1895.

PECK, JAMES I. 1895. The Sources of Marine Food. *Bull. U. S. Fish Com.*, XV.

RUSSELL, ISRAEL C. 1895. *Lakes of North America*. Boston: Ginn & Co.

WARREN, H. E., and WHIPPLE, G. C. 1895. The Thermophone, a new instrument for obtaining the temperature of a distant or inaccessible place; and Some Observations on the Temperature of Surface Waters. *Am. Meteor. Jour.*, XII, June, 1895.

WARREN, H. E., and WHIPPLE, G. C. 1895. The Thermophone, a new instrument for determining temperatures. *Tech. Quart.*, VIII, July, 1895.

DOLLEY, C. S. 1896. The Planktonokrit, a Centrifugal Apparatus for the Volumetric Estimation of the Food Supply of Oysters and other Aquatic Animals. *Proc. Acad. Nat. Sci., Philadelphia*, 276-80.

JACKSON, D. D. 1896. On an Improvement in the Sedgwick-Rafter Method for the Microscopical Examination of Drinking Water. *Tech. Quarterly*, IX, Dec., 1896.

- KEMNA, AD. 1896. *La Couleur des Eaux*. Bull. d. l. Société Belge de Géologie, de Paléontologie et d'Hydrologie (Bruxelles), X, 224-279, 1896.
- WHIPPLE, GEO. C. 1896. *Experience with the Sedgwick-Rafter Method*. *Technology Quarterly*, IX, Dec., 1896.
- DAVENPORT, CHAS. B. 1897. *Experimental Morphology*. Part I. Effect of Chemical and Physical Agents upon Protoplasm. Part II. Effect of Chemical and Physical Agents upon Growth. New York: Macmillan Co.
- FIELD, GEO. W. 1897. *Methods in Planktology*. 10th An. Rept. Rhode Island Agricultural Experiment Station, 1897.
- JACKSON, D. D., and ELLMS, J. W. 1897. *On Odors and Tastes of Surface Waters, with special reference to Anabæna*. *Technology Quarterly*, X, Dec., 1897.
- KOFOID, CHAS. A. 1897. *On Some Important Sources of Error in the Plankton Method*. *Science*, N. S., VI, Dec. 3, 1897.
- STROHMEYER, O. 1897. *Die Algenflora d. Hamburger Wasserwerkes*. Leipzig, Bot. Centralb. 1898, 406.
- FORDYCE, CHAS. 1898. *A New Plankton Pump*. *Proc. Nebraska Hist. Soc.*, 2d Series, II.
- HOLLIS, F. S. 1898. *Methods for the Determination of Color of Water and the Relation of Color to the Character of Water*. *Jour. N. E. W. W. Assoc.*, 1898.
- JACKSON, D. D. 1898. *An Improved Filter for Microscopical Water Analysis*. *Tech. Quarterly*, XI, Dec., 1898.
- REIGHARD, JACOB. 1899. *A Plan for the Investigation of the Biology of the Great Lakes*. *Transactions of the American Fisheries Society*, 28th Annual Meeting, pp. 65-71.
- AMERICAN PUBLIC HEALTH ASSOCIATION. 1900. *First Report of Progress of Committee on Standard Methods of Water Analysis*. Reprint from *Science*, N. S. Vol. XII, No. 311, pp. 906-915. December 14, 1900.
1901. *Second Report of Progress of Committee on Standard Methods of Water Analysis*. Vol. XXVII *Amer. Public Health Assn.*, p. 377.
1902. *Third Report of Progress of Committee on Standard Methods of Water Analysis*. Vol. XXVIII, p. 388.
1905. *Final Report, Journal of Infectious Diseases, Supplement, No. 1, 1905*.
1912. *Second Edition of the Report of the Committee, Published by the Association*, 289 4th Ave., New York.
- HOLLIS, FREDERICK S. 1900. *On the Distribution of Growths in Surface Water Supplies*. *Trans. Amer. Microscopical Soc.*, 23d Annual Meeting, June, 1900. Vol. XXII.
- PARKER, HORATIO N. 1900. *Some Advantages of Field Work on Surface-water Supplies*. *Transactions of the Amer. Microscopical Soc.*, June, 1900.
- WHIPPLE, G. C. 1900. *Discussion of Filtration*. *Trans. Am. Soc. C. E.*, XLIII, p. 318.
- FOREL, DR. F. A. 1901. "*Handbuch der Seenkunde*." Stuttgart. J. Engelhorn. (An excellent short treatise on general limnology.)
- HYAMS, ISABEL F., and RICHARDS, ELLEN H. 1901. *Notes on Oscillaria Pronnca*. (IV) *Life History*. *Tech. Quart.*, Vol. XIV, No. 4, Dec. (V) *Chemical Composition*. *Tech. Quart.*, Vol. XIV, No. 4, Dec., 1901.

- KEMNA, AD. 1901. Articles Bibliographiques sur les eaux. Bulletin de la Société Belge de Paléontologie et d'Hydrologie. November, 1901.
- WHIPPLE, G. C. 1901. Discussion of Filtration. Trans. Am. Soc. C. E., XLVI, P. 343.
- WHIPPLE, GEO. C., and PARKER, HORATIO N. 1901. The Amount of Oxygen and Carbonic Acid Dissolved in Natural Waters and the Effect of these Gases upon the Occurrence of Microscopic Organisms. Trans. Amer. Microscopical Soc. August, 1901, Vol. XXIII.
- HOLLIS, FREDERICK S. 1902. Two Growths of Chlamydomonas in Connecticut. Trans. Amer. Microscopical Soc., June, 1902.
- BIRGE, E. A. 1903. The Thermocline and its Biological Significance. Transactions of the Amer. Microscopical Soc., 26th Annual Meeting, July 29, 1903.
- FIELD, GEORGE W. 1903. Certain Biological Problems Connected with the proposed Charles River Dam. Appendix No. 6. Report of the Committee, Charles River Dam.
- HAZEN, ALLEN. 1903. The Physical Properties of Water. Journal of the New England Water Works Assn., Vol. XVII, 1903.
- HAZEN, ALLEN, and WHIPPLE, GEO. C. 1903. Measurement of Turbidity and Color. Circular No. 8, Division of Hydrography, Dept. of Interior, U. S. Geological Survey.
- MOORE, GEO. T. 1903. Methods for Growing Pure Cultures in Algæ. Journal of Applied Microscopy and Laboratory Methods. Vol. VI, No. 5, 1903.
- IMBEAUX, DR. ED. 1904. Odeur, Couleur et Limpidité de l'eau. Bulletin des seances de la Société des Sciences de Nancy, 1904.
- MOORE, GEO. T., and KELLERMAN, KARL F. 1904. A method of destroying or preventing the growth of algæ and certain pathogenic bacteria in water supplies. Bulletin 64, Bureau of Plant Industry, U. S. Department of Agriculture.
- RICHARDS, ELLEN H., and WOODMAN, ALPHEUS G. 1904. Air, Water and Food. 2d edition. John Wiley & Sons, New York, 1904.
- SPRINGFIELD, MASS. Reports of Special Commission on Water Supply. March 28, June 6, Oct. 31, 1904.
1900. Report of the Chemist of the Mass. State Board of Health upon the Experimental Filtration of the Water Supply of Springfield, at Ludlow, Mass. From Dec. 21, 1900, to Jan. 31, 1902.
1902. Special Report on Improvement of Present Water Supply. April 14, 1902. Board of Water Commissioners.
1905. Report of State Board of Health, to Board of Water Commissioners, Feb. 2, 1905.
- WINSLOW, C.-E. A., and UNDERWOOD, WM. LYMAN. 1904. Report on the Sanitary Problems relating to the Fresh Marshes and Alewife Brook. In Special Report on Improvement of the Upper Mystic Valley. Metropolitan Park Commission, Boston.
- CAIRD, JAS. M. 1905. The Copper Sulphate Treatment for Algæ at Middletown, N. Y. Eng. News, Jan. 12, 1905, p. 33.
- CLARK, H. W. 1905. Investigations in Regard to the Use of Copper and Copper Sulphate. Annual Report of the Mass St. Bd. of Health, 1905, p. 292.

- GOODNOUGH, X. H. 1905. Experiments upon the Removal of Organisms from the water of Ponds and Reservoirs by the Use of Copper Sulphate. Annual Report, Mass. St. Bd. of Health, 1905, p. 209.
- MOORE, GEO. T., and KELLERMAN, KARL F. 1905. Copper as an algicide and disinfectant in water-supplies. Bulletin 76, Bureau of Plant Industry, U. S. Department of Agriculture.
- MOORE, GEO. T., JACKSON, D. D., GOODNOUGH, X. H., and others. 1905. A Symposium on the Use of Copper Sulphate and Metallic Copper for the Removal of Organisms and Bacteria from Drinking Water. Jour. New England Water Works Association, XIX, No. 4, p. 474.
- BALDWIN, H. B., and WHIPPLE, G. C. 1906. Observed Relations between Carbonic Acid and Algæ Growths in Weequahic Lake, N. J. Rept. Am. Pub. Health, 32: 167-182.
- CAIRD, JAS. M. 1906. Copper Sulphate Results. Proc. Am. W. W. Asso., 1906, p. 249.
- KELLERMAN, KARL F., and BECKWITH, T. D. 1906. The Effect of Copper upon Water Bacteria. Bulletin 100, Part VII, Bureau of Plant Industry, U. S. Dept. of Agriculture.
- KELLERMAN, KARL F., PRATT, R. WINTHROP, and KIMBERLEY, A. ELLIOTT. 1907. The disinfection of sewage effluents for the protection of public water-supplies. Bulletin 115, Bureau of Plant Industry, U. S. Department of Agriculture.
- LOCHRIDGE, E. E. 1907. The Springfield Water Works. (Containing a description of the Ludlow Filter.) Jour. N. E. W. W. Asso., XXI, p. 279.
- STORY, CARROLL F. 1909. The Ludlow Filters. Jour. N. E. W. W. Asso. Vol. XXIII, p. 229.
- TIGHE, JAMES L. 1909. Odors and Tastes in the Water Supply of Holyoke. Jour. N. E. W. W. Assc. XXIII, p. 324.
- LOVEJOY, W. N. 1910. Filter Troubles caused by Micro-organisms at Louisville. Eng. Rec., Vol. 62, p. 664.
- MURRAY, SIR JOHN, and PULLAR, LAURENCE. 1910. Bathymetrical Survey of the Scottish Fresh Water Lochs. Edinburgh. Challenger Office. (This is a set of six magnificent volumes containing the reports of scientific researches made by the authors and their associates during the years 1897 to 1909. Vol. I contains the principal general articles. The last five contain chiefly maps. The subject of seiches is particularly well treated. Associated with Sir John Murray, were such men as Prof. George Chrystal, E. M. Wedderburn, George West, and Dr. C. Wesenberg-Lund.)
- STEUER, DR. ADOLF. 1910. Planktonkunde. Leipzig. B. G. Teubner. (Considers the fresh water plankton, but is devoted chiefly to marine plankton.)
- WILCOX, WM. F. 1910. Creosote Treatment for Algæ Growth. Proc. Am. W. W. Asso., 1910, p. 166.
- BIRGE, E. A., and JUDAY, C. 1911. The Inland Lakes of Wisconsin; Dissolved Gases and their Biological Significance. Wisconsin Survey. Bull. 22. (Sci. Series 7.)
- DOWNES, JOHN R. 1911. A Study of the Water Supplies of the Isthmus of Panama. Proc. Med. Asso. of Isthmus of Panama, Sept., 1911.
- ELLMs, JOS. W. 1911. Hypochlorite for Destroying Growths of Algæ and Diatoms at Cincinnati. Eng. Record, Vol. 63, p. 388.

- MARSSON, DR. MAXIMILIAN. 1911. *The Significance of Flora and Fauna in Maintaining the Purity of Natural Waters*. Translated by Emil Knuchling, *Eng. News*, Aug. 31, 1911, Vol. LXVI, p. 246.
- MAST, S. O. 1911. *Light and the Behavior of Organisms*. New York. John Wiley & Sons.
- STEUER, DR. ADOLF. 1911. *Leitfaden der Planktonkunde* Leipsig. G. B. Teubner. (A shorter treatise than the preceding and on the whole better adapted to those interested in fresh water.)
- KELLERMAN, KARL F. 1912. *The Rational Use of Disinfectants and Algicides in Municipal Water Supplies*. Eighth International Congress of Applied Chemistry. Vol. 26, p. 241. Abstract in *Wasser und Abwasser*, Vol. VI, 1913.
- MURRAY, SIR JOHN. 1912. *The Depths of the Ocean*. London: Macmillan Co. (While devoted to marine studies this is one of the most inspiring books for any one who is interested in limnology.)
- BIRGE, E. A. 1913. Absorption of Light by Water. *Science*, Nov. 14, p. 702.
- FORBES, STEPHEN A., and RICHARDSON, R. E. 1913. Studies on the Biology of the Upper Illinois River. *Bulletin of the Illinois State Laboratory of Natural History*, Vol. IX, Article X.
- GELSTON, W. R. 1913. Algæ in the Water-works Reservoir at Quincy, Ill. *Eng. News*, Vol. 69, p. 835.
- THRESH, DR. JOHN C. 1913. *The Examination of Waters and Water Supplies*. 2d Edition, Philadelphia, P. Blakiston's Son & Co. (A general treatise on water analysis, with a chapter on microscopical examination, with numerous plates. A fair representation of present English practice.)
- WHIPPLE, G. C. 1913. Decarbonation as a Means of Removing the Corrosive Properties of Public Water Supplies. *Journal N. E. W. W. Asso.* Vol. XXVII, No. 2, p. 193.

## GENERAL INDEX

### A

- Absorption of light by water, 116
- Aerating fountains, 263
- Aeration, 236, 261
  - by percolation, 269
- Aeration experiments, 262
- Aeratory nozzles, 265
- Albany, N. Y., filters, 265
- Algæ as local nuisances, 205
  - hygienic effect of, 215
  - injurious character, 200
  - relation to gases, 128
  - use of term, 287
- American Public Health Association, 8
- Anabæna, occurrence of, 154
- Antwerp studies on filtration, 270
- Area of lakes, 151
- Aromatic odors, 196
- Asellus aquaticus, 281
- Ashokan reservoir, treatment of, 233, 234
- Asterionella in Ridgewood reservoir, 247
- Attractiveness of water, 201

### B

- Bacillariæ, 288
- Bacteria, effect of copper sulphate on, 257, 258
- Bacteriological examination of water, 8
- Barnes' electrical thermometer, 87
- Berlin water supply, 250
- Biological balance of streams, 82
- Birge, Dr. A. E., 6, 7, 126
- Birge's plankton net, 22
- Bleaching of water during storage, 109
- Boston, organisms in pipes, 282
- Boston Water Works Laboratory, 2
- Bottoms of reservoirs, 214

- Brisbane, Australia, filters at, 237
- Brooklyn, pipe moss in, 285
- Bryozoa, 378
  - in pipes 283
- Bunker, John W. M., 49, 158
- Bunker's stand for Sedgwick-Rafter method, 31
- By-passes, 260

### C

- Camera lucida, 65
- Canal waters, 79
- Carbonic acid, determination of, 122
  - diffusion of, 125
  - removal from water by algæ, 216
  - seasonal changes, 128
  - solubility of, 124
  - sources of, 125
- Care of the microscope, 59, 60, 61, 62
- Cedar Swamp, 207
- Celiata, 357
- Cell, Bunker's, 35
  - Sedgwick-Rafter, 34
- Chambers, Dr. Charles O., 128
- Charleston, S. C., water supply of, 239
- Chemical analysis of water, 8, 12
  - relation to microscopic organisms, 142
- Chestnut Hill Reservoir, 166
- Chicago Drainage Canal, 161
- Chlamydothrix, 249
- Chlorine, excess of, 143
- Chlorophyceæ, 288
  - seasonal distribution, 170
- Circulation periods in lakes, 102
- Cladocera, 375
- Classification of lakes, 99
  - of organisms, 286
- Clonothrix, 249

Closed community, 126  
 Cochituate, Lake, 91, 95  
   seasonal distribution of organisms, 173  
   carbonic acid in, 213  
   dissolved oxygen in, 213  
 Cochituate, stagnation of, 211  
 Color of water, 107  
   photography, 70  
   relation to organisms, 153  
 Compressibility of water, 83  
 Concentration of sample, 32  
 Connecticut, algæ in, 158  
 Copepoda, 374  
 Copper sulphate, effect on fish, 256  
   method of using, 252  
   nature of reaction, 252  
   quantity required, 253, 254  
   treatment for algæ, 251  
   used before filtration, 259  
 Cordylophora, 281  
 Cotton filter, 47  
 Crenothrix, 75, 249  
   in sand filters, 273  
 Creosote treatment for algæ, 259  
 Croton water supply, algæ in, 154  
 Crustacea, 373  
   seasonal distribution of, 173  
 Cucumber taste, 191  
 Currents in lakes, 103  
 Cyanophyceæ, 316  
   seasonal distribution of, 170

D

Decomposition, 118  
 Demonstration eye-piece, 68, 71  
 Density of water, 83  
 Depth, effect of, on organisms, 141, 152  
   relation to organisms, 184  
 Desmidiæ, 332  
 Diathermancy of water, 85  
 Diatomaceæ, 291  
   seasonal distribution, 165  
 Diatom cells, 291  
   cell contents 295,  
   classification, 303  
   external secretions, 296  
   markings 294  
   movement, 296  
   multiplication, 301  
   reproduction, 303  
 Disk for measuring transparency, 115

Dissolved oxygen, collection of samples  
   for, 26  
   determination of, 119  
   diffusion of, 125  
   seasonal changes, 126  
   solubility of, 121  
   sources of, 125  
 Dodge, Prof. Chas. Wright, 159  
 Double filtration, 274  
 Downes, John R., 214  
 Dreyssena, 281  
 Drown, Dr. T. M., 146, 223

## E

Ecology, 13  
 Edinger camera, 67  
 Entomostraca, 373  
 Enumeration of organisms, 37  
 Errors in Sedgwick-Rafter method, 38  
 Eurich's collecting apparatus, 17  
 European plankton studies, 5  
 Eye-piece of microscope, 52

## F

Farm Pond, 191  
 Field work, 71  
 Filter scums, 272  
 Filtered water, organisms in, 81  
   storage of, 248  
 Filtration, 236  
   of algæ laden water, 269, 273  
   of samples, 28  
 Find objects under microscope, 52  
 Fish, death of, 132  
   killed by copper sulphate, 256  
   life, food supply of, 13  
 Fishy odors, 197  
 FitzGerald, Desmond, 224  
 Floating roofs, 250  
 Flotation of plankton, 176  
 Focusing, 55  
 Forbes, 161  
 Forel, F. A., limnological studies, 5  
 Fowler, Prof. W. G., 220  
 Frequency, index of, 149  
 Fresh Pond, 127  
 Fteley, Alphonse, 220  
 Fuller, Geo. W., 218  
 Fungi, 171, 341  
 Funnel for Sedgwick-Rafter method, 29

## G

- Gallionella, 249  
 Gammarus pulex, 281  
 Gases dissolved in water, 117  
 Genesee River, 159  
 Goodnough, X. H., 224  
 Grassy odors, 197  
 Ground water, 74  
   mixed with surface water, 247  
   storage of, 246  
 Growths, irregularity of, 227  
   temporary, 229

## H

- Hardness of water, 143  
 Hassell's method of microscopical examination, 1  
 Hazen, Allen, 218, 265  
 Hensen, Victor, plankton studies, 5  
 Heterokontæ, 288  
 Hoover, C. P., 216  
 Horizontal currents, 103, 104  
 Horizontal distribution of organisms, 175  
 House filters, 275  
 Human system, effect of copper sulphate on, 251  
 Hypochlorite treatment for algæ, 260

## I

- Ice, algæ in, 163  
 Illinois River, 161  
   aeration in, 263  
 Illumination of microscopes, 53, 59  
 Index of frequency, 149  
 Infiltration galleries, 75  
 Internationale Revue der Gesamten Hydrobiologie, 6  
 Iron bacteria, 313

## J

- Jackson's theory of diatom movement, 297  
 Juday, Dr. Chauncey, 128

## K

- Kean, A. L., method of water examination, 3  
 Kellerman, Karl F., 251  
 Kemna, Ad., 270

- Kensico aeraters, 265  
 Kensico reservoir, treatment of, 235, 240, 243, 245

## L

- Lake Winnepesaukee, 93  
 Lakes, organisms in, 81  
 Leitz' demonstration eye-piece, 68  
   step micrometer, 64  
 Light, effect on diatom growth, 167  
 Limnetec organisms, 175  
 Limnological Commission, 6  
 Limnology, 83  
 Littoral organisms, 175  
 Lochridge, E. E., 239, 265  
 Lynn, water supply of, 79  
 Ludlow filter, 273  
 Ludlow reservoir, filter experiments, 238

## M

- Macdonald, J. D., method of microscopical examination, 2  
 Magnification, 64  
 Malacostraca, 373  
 Marsson's investigations, 81  
 Massachusetts, algæ in, 155  
   microscopic organisms of, 137  
   soil stripping in, 225  
   State Board of Health, 7  
 McGregor Lake, 183  
 Measurement of objects, 62  
 Mendota, Lake, 116  
   dissolved oxygen, 130  
 Metropolitan water supply, algæ in, 155  
   Water Works laboratory, 2  
 Micrometer, 64  
   Sedgwick-Rafter method, 36  
 Microscope, construction of, 49  
   for Sedgwick-Rafter method, 35  
   use of, 49, 51  
 Microscopic organisms, occurrence of, 133  
 Microscopical examination of water, various aspects, 10  
 Molisch, Dr. Hans, 250, 314  
 Moore, Dr. Geo. T., 251  
 Mt. Prospect Laboratory, 2  
 Murray, Sir John, studies in the Scottish lakes, 6  
 Myxophyceæ, 288

## N

- Newcomb filter, 275  
 New England data regarding organisms, 148  
 New York Water Works Laboratory, 3  
 Nichols, Wm. Ripley, 219, 220  
 Nitrates, 146  
 Nitrogenous food of organisms, 230

## O

- Objective, method of using, 52  
 Odor, relation to organisms, 151  
 Odors, cause of, 12  
   caused by decomposition, 188, 198  
   caused by littoral plants, 191  
   caused by organic matter, 187  
   caused by organisms, 189  
   caused by plankton, 194  
   classification of, 187  
   in Massachusetts water supply, 199  
   in water supplies, 186  
   of decomposition, 258  
 Oils, odors caused by, 195  
 Ontario, Lake, algæ in, 158  
 Optics of the microscope, 57  
 Organisms as sources of food, 230  
 Origin of waters, 12  
 Owasco Lake, 103  
 Oysters, food of, 13

## P

- Panama, water supplies, 214  
 Parker, G. H., method of water examination, 3  
 Peck, James I., 7  
 Phæophyceæ, 288  
 Photosynthesis, 117  
 Photomicrographic camera, 66  
 Physical examination of water, 8  
   properties of water, 83  
 Pipe moss, 281, 283, 284  
 Pipes, organisms in, 277, 278, 279  
 Plankton, distribution of, 136  
   estimation of, 22  
   flotation of, 176  
   net, 17  
   odors of, 193  
   pump, 24  
   studies in Europe, 5  
   studies in United States, 6

- Planktonokrit, 45  
 Pockets, effect of, 208  
 Population, relation to organisms, 153  
 Portable microscope, 70  
 Polyzoa, 378  
 Potomology, 82  
 Practice exercises with the microscope, 56  
 Precision of Sedgwick-Rafter method, 41  
 Preservation of specimens, 25  
 Projection of photomicrographs, 69  
 Protozoa, 288, 344  
   seasonal distribution of, 171  
 Protozoan cell, 345  
 Pure water, value of, 200

## R

- Rafter, George W., 220  
   method of microscopical examination, 4  
 Rain water, 73  
 Raphidomonas, 79  
 Reading, Pa., filters at, 237  
 Records of examination, 45  
 References, microscope, 72  
 Reighard's net, 21  
 Reservoir stripping, 218  
 Reservoirs, organisms in, 81  
 Respiration, 117  
 Results of microscopical examination, 42  
 Rhodophyceæ, 288  
 Ridgewood reservoir, 247  
 River waters, 77  
 Rotifera, 365  
   seasonal distribution of, 172  
 Rotterdam water calamity, 281

## S

- Schizomycetes, 171, 312  
 Samples, collection of, 14  
 Sanitary examination of water, 9  
 Seasonal distribution of algæ, 164  
 Secondary growths of organisms after copper treatment, 257  
 Sedgwick-Rafter method, 28  
 Sedgwick, Wm. T., method of microscopical examination, 4  
 Seeding reservoirs with organisms, 228  
 Seiches, 106  
 Self-purification in Genessee River, 159  
   of streams, 11

Sewage pollution, 10  
 as source of food, 231  
 Shearing plane, 104  
 Sling filter, 32  
 Smith, J. Waldo, 218  
 Soil stripping, 218, 224  
 advantages of, 232  
 comparative cost, 233  
 effect on cost of filtration, 240  
 Sorby, H. C., method of microscopical  
 examination, 2  
 Sponge, fresh water, 192  
 Spongilla, 281  
 Spongidae, 381  
 Springfield filter, 265  
 Sprüingschicht, 96  
 Squam Lake, 95  
 Stagnation, effect on quality of water,  
 226  
 in reservoirs, 209  
 of water, 92  
 Standard Methods of Water Analysis, 8  
 Standard unit, 42  
 Stearns, Frederick P., 146, 223  
 Steuer's collecting apparatus, 15  
 Strainer jars, 17  
 St. Thomas, Ont., 259  
 Storage period, 153  
 of filtered water, 248  
 ground-water, 246  
 surface-water, 206  
 Stripping reservoir sites, 218  
 Strohmeier's experiments, 217  
 Sub-stage diaphragm, 56  
 Summer temperature conditions, 94,  
 Surface waters, 77  
 Swamp land, effect of, 206

## T

Temperature changes in pipes, 277  
 of lakes, 89  
 of surface water, 231  
 Thermal conductivity of water, 84

Thermocline, 96  
 Thermometry, 85  
 Thermophone, 87  
 Transition zone, 95  
 organisms at, 179  
 Transmission of light by water, 107  
 Transparency of water, 113  
 Turbidity of water, 111

## U

Undertow currents, 103  
 U. S. Geological Survey,  
 apparatus, 180  
 turbidity rod, 112

## V

Value of pure water, 200  
 Vertical distribution of organisms, 177  
 Viscosity of water, 84  
 effect on organisms, 181  
 Volume of water in reservoirs, 256

## W

Ward, Henry B., 6, 7  
 Weeds as source food, 230  
 Weequahic Lake, 132  
 Wesenberg-Lund, 182  
 West, Prof. G. S., 287  
 Whipple, Melville C., 158, 262  
 Whipple's collecting apparatus, 15  
 Wilcox, Wm. F., 259  
 Wilhelmis plankton pump, 25  
 Wind and agitation, 231  
 Winter temperature conditions, 93  
 Wizard sediment tester, 47

## Z

Zacharias, Otto, plankton studies, 5  
 Zoogloea, 42





	PLATE	PAGE		PLATE	PAGE
Diaptomus . . . . .	XVII	375	Leptothrix . . . . .	IV	312
Diatoma . . . . .	III	309	Lyngbya . . . . .	V	322
Dictyosphærium . . . . .	VI	328			
Diffugia . . . . .	XI	349	M		
Diglena . . . . .	XVI	370	Macrobiotus . . . . .	XIX	384
Dimorphococcus . . . . .	VI	328	Mallomonas . . . . .	XII	346, 355
Dinobryon . . . . .	XII	355	Mastigocerca . . . . .	XVI	371
Docidium . . . . .	VII	333	Melicerta . . . . .	XV	368
Draparnaldia . . . . .	X	326, 339	Melosira . . . . .	III	310, 346
			Meridion . . . . .	III	309
E			Merismopedia . . . . .	IV	319
Enchelys . . . . .	XIV	362	Meyenia . . . . .		382
Encyonema . . . . .	I	305	Micrasterias . . . . .	VIII	334
Epistylis . . . . .	XIII	359	Microcodon . . . . .	XV	369
Epithemia . . . . .	I	307	Microcoleus . . . . .	V	323
Euastrum . . . . .	VIII	334	Microcystis . . . . .	IV	298, 319
Eudorina . . . . .	VII	331	Monas . . . . .	XII	352
Euglena . . . . .	XII	353	Mucor . . . . .	X	343
Euglypha . . . . .	XI	349	Myriophyllum . . . . .		384
Eunotia . . . . .	I	307			
Euplotes . . . . .	XIII	358	N		
			Nais . . . . .	XIX	384
F			Nassula . . . . .	XIV	362
Floscularia . . . . .	XV	367	Navicula . . . . .	I	306
Fragilaria . . . . .	II	308	Nephrocytium . . . . .	VI	328
Fredericella . . . . .	XVIII	379	Nitella . . . . .	XIX	339
Gallionella . . . . .		314	Nitzschia . . . . .	III	309
Gammarus pulex . . . . .		373	Nostoc . . . . .	IV	321
Glenodinium . . . . .	XIII	357	Notholca . . . . .	XVII	371
Glœcapsa . . . . .	IV	318	Noteus . . . . .		371
Glœcystis . . . . .	V	327			
Glœothece . . . . .		320	O		
Gomphonema . . . . .	I	306	Ophiocytium . . . . .	VI	329
Gonium . . . . .	VII	332	Oscillaria . . . . .	V	323
Gordius . . . . .		384			
Gymnodinium . . . . .		357	P		
			Palmella . . . . .	V	327
H			Paludicella . . . . .	XVIII	379
Halteria . . . . .	XIII	359	Pandorina . . . . .	VII	298, 331
Heteromeyenia . . . . .		382	Paramaecium . . . . .	XIV	361
Heterophrys . . . . .		350	Pectinatella . . . . .	XVIII	379
Himantidium . . . . .	II	308	Pediastrum . . . . .	VI	329, 335
Hippuris . . . . .		384	Penicillium . . . . .	X	342
Hyalotheca . . . . .	IX	334	Penium . . . . .	VII	333
Hydatina . . . . .		370	Peridinium . . . . .	XIII	356
Hydra . . . . .	XIX	384	Phacus . . . . .	XII	353
Hydrodictyon . . . . .	VI	329	Pleuronema . . . . .	XIV	362
			Pleurosigma . . . . .	I	306
L					
Lemna . . . . .	XIX	384			
Leptomitus . . . . .	XI	343			

	PLATE	PAGE
Plumatella . . . . .	XVIII	379
Polyarthra . . . . .	XVI	370
Polyedrium . . . . .	VI	329
Potamogeton . . . . .	XIX	384
Protococcus . . . . .	VI	328
Raphidium . . . . .	VI	328
Raphidomonas . . . . .	XII	352
Rivularia . . . . .	V 317,	324
Rotifer . . . . .	XV	368

S

Saccharomyces . . . . .	X	342
Saprolegnia . . . . .	XI	343
Scenedesmus . . . . .	VI	329
Schizonema . . . . .	I	306
Scytonema . . . . .	V	323
Sida . . . . .	XVIII	376
Sirosiphon . . . . .	V	323
Sorastrum . . . . .	VI	330
Sphaerosozma . . . . .	IX	336
Sphaerozyga . . . . .	V	321
Spirogyra . . . . .	IX 326,	336
Spongella . . . . .	XVIII	382
Staurastrum . . . . .	VIII 298,	334
Staurogenia . . . . .	VI	330
Stauroneis . . . . .	I	306
Stentor . . . . .	XIV	360
Stephanodiscus . . . . .	III	310
Stigeoclonium . . . . .	X 298,	339
Suirella . . . . .	III 3 ♂	
Synchaeta . . . . .	XVI	369
Syncrypta . . . . .	XII	354
Synedra . . . . .	II	308
Synura . . . . .	XII	354

T

	PLATE	PAGE
Tabellaria . . . . .	III	309
Tetmemorus . . . . .	VII	334
Tetrapedia . . . . .		320
Tetraspora . . . . .	V 327,	335
Tintinnus . . . . .	XIII	360
Trachelocerca . . . . .	XIV	362
Trachelomonas . . . . .	XII	352
Triarthra . . . . .	XVI	370
Trinema . . . . .	XI	350
Tubella . . . . .		382
Tubifex . . . . .		384

U

Ulothrix . . . . .	IX	338
Uroglena . . . . .	XII	354
Utricularia . . . . .		384
Uvella . . . . .	XII	354

V

Vaucheria . . . . .	IX	337
Volvox . . . . .	VII	331
Vorticella . . . . .	XIII 346,	359

X

Xanthidium . . . . .	VIII	334
----------------------	------	-----

Z

Zoothamnium . . . . .		359
Zygnema . . . . .	IX 326,	337
Zygogonium . . . . .	IX	337



PLATE I.

*DIATOMACEÆ.*

# PLATE I

## DIATOMACEÆ

Magnification 500 diameters

Fig. A. *Navicula viridis*, valve view.

“ B. *Navicula viridis*, girdle view.

“ C. *Navicula viridis*, transverse section.

*a*, Outer, or older valve. *b*, Inner, or younger valve. *c, c'*, Connective bands, or girdles. *d*, Central nodule. *ee*, Terminal nodules. *f*, Raphé. *g*, Furrows. *m*, Chromatophore plates. *n*, Nucleus. *o*, Oil globules. *p*, Cavities. *u*, Protoplasm.

Figs. D, E, F. *Navicula viridis*, sectional views showing multiplication by division. After Deby.

*a*, Valve. *b*, Girdle. *c*, Protoplasm. *d*, Chromatophore plates. *e*, Central cavities. *f*, Nucleus and nucleolus. *g*, Oil globules.

	PAGE
Fig. 1. Amphora, valve view . . . . .	305
“ 2. Amphora, girdle view . . . . .	305
“ 3. Cymbella, valve view . . . . .	305
“ 4. Cymbella, valve view . . . . .	305
“ 5. Encyonema. <i>A</i> , valve view. <i>B</i> , girdle view . . . . .	305
“ 6. Cocconeis. <i>A</i> , valve view. <i>B</i> , girdle view . . . . .	305
“ 7. <i>Navicula gracilis</i> , valve view . . . . .	306
“ 8. <i>Navicula Rhyncocephara</i> , valve view . . . . .	306
“ 9. <i>Stauroneis</i> , valve view . . . . .	306
“ 10. <i>Stauroneis</i> , girdle view . . . . .	306
“ 11. <i>Pleurosigma</i> , valve view . . . . .	306
“ 12. <i>Gomphonema</i> . <i>A</i> , valve view. <i>B</i> , girdle view . . . . .	306
“ 13. <i>Cocconeis</i> , valve view . . . . .	307
“ 14. <i>Cocconeis</i> , girdle view . . . . .	307
“ 15. <i>Epithemia</i> , valve view . . . . .	307
“ 16. <i>Epithemia</i> , girdle view . . . . .	307
“ 17. <i>Eunotia</i> , valve view . . . . .	307

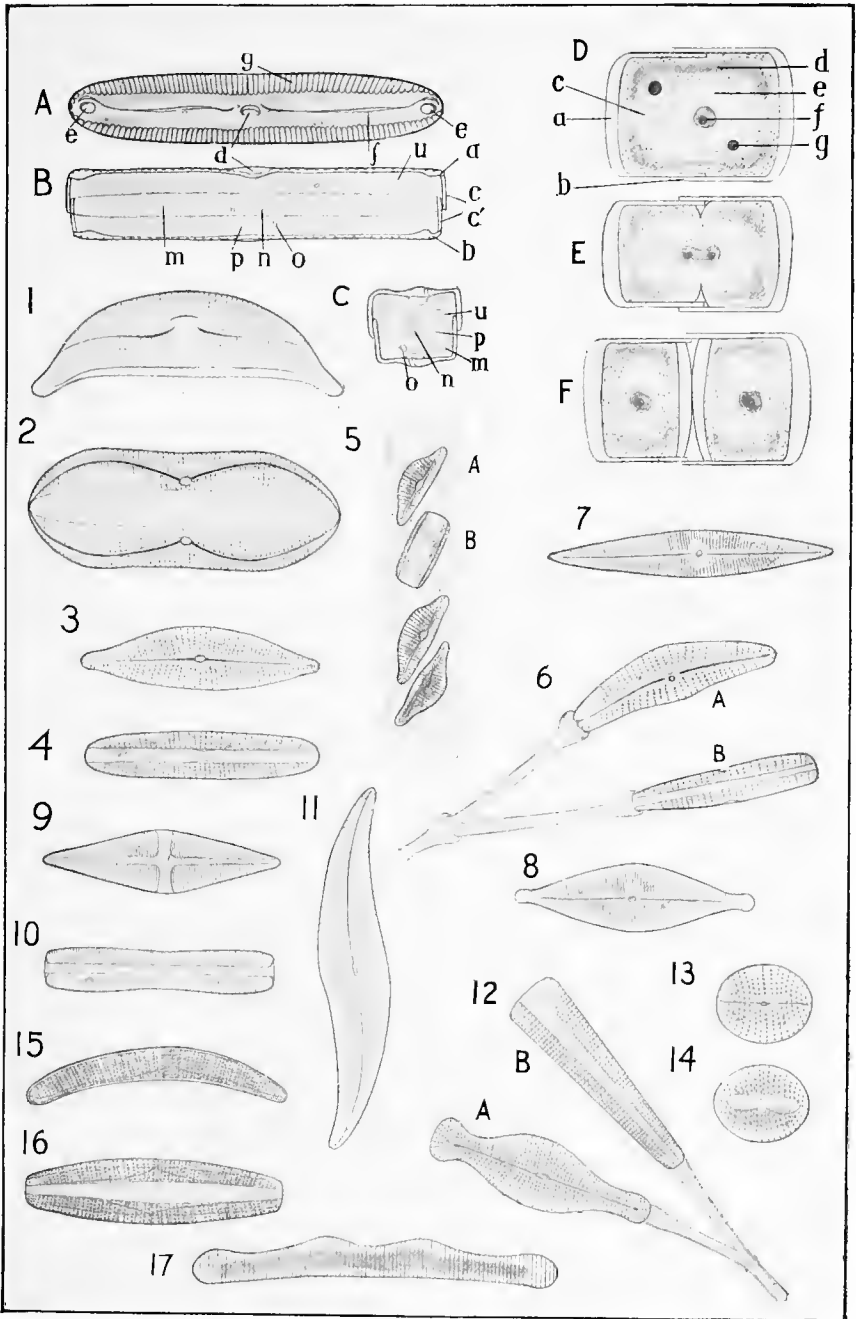



PLATE II.

*DIATOMACEÆ.*

## PLATE II

### DIATOMACEÆ

Magnification 500 diameters

	PAGE
Fig. 1. Himantidium, valve view . . . . .	303
“ 2. Himantidium, girdle view . . . . .	308
“ 3. Asterionella, valve view . . . . .	308
“ 4. Asterionella, girdle view (typical form) . . . . .	308
“ 5. Asterionella, girdle view, showing division of the cells . . . . .	308
“ 6. Asterionella, girdle view, showing rapid multiplication . . . . .	308
“ 7. Asterionella. <i>A</i> , valve view. <i>B</i> , girdle view . . . . .	308
“ 8. Synedra pulchella, valve view . . . . .	308
“ 9. Synedra pulchella, girdle view . . . . .	308
“ 10. Synedra ulna, valve view . . . . .	308
“ 11. Synedra ulna, girdle view . . . . .	308
“ 12. Fragilaria, girdle view . . . . .	308
“ 13. Fragilaria, valve view . . . . .	308

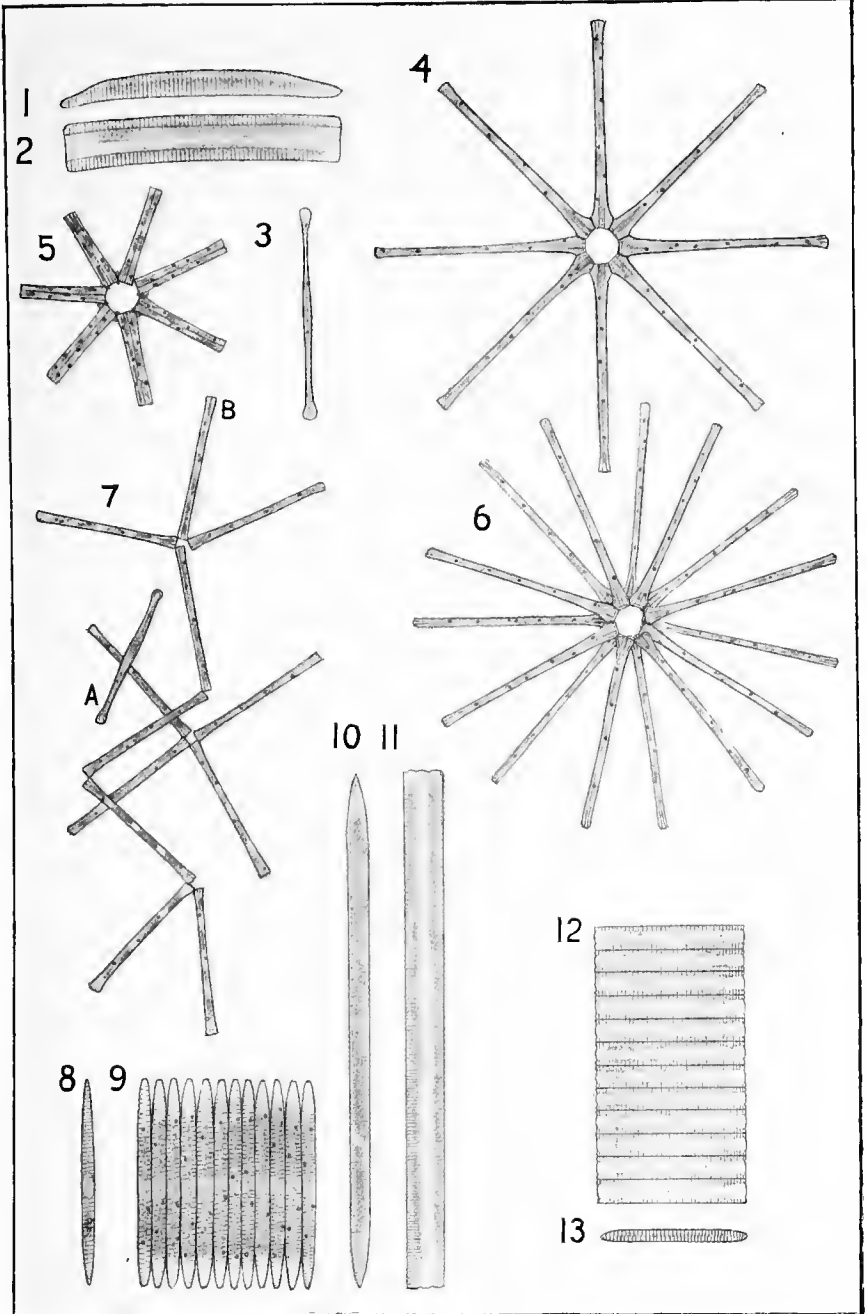



PLATE III.

*DIATOMACEÆ.*

## PLATE III

### DIATOMACEÆ

Magnification 500 diameters

	PAGE
Fig. 1. <i>Diatoma vulgare</i> , valve view . . . . .	300
“ 2. <i>Diatoma vulgare</i> , girdle view . . . . .	309
“ 3. <i>Diatoma tenue</i> , girdle view . . . . .	309
“ 4. <i>Meridion circulare</i> , valve view . . . . .	309
“ 5. <i>Meridion circulare</i> , girdle view . . . . .	309
“ 6. <i>Tabellaria fenestrata</i> , valve view . . . . .	309
“ 7. <i>Tabellaria fenestrata</i> , girdle view . . . . .	309
“ 8. <i>Tabellaria flocculosa</i> , valve view . . . . .	309
“ 9. <i>Tabellaria flocculosa</i> , girdle view . . . . .	309
“ 10. <i>Nitzschia sigmoïda</i> , valve view . . . . .	309
“ 11. <i>Nitzschia sigmoïda</i> , girdle view . . . . .	309
“ 12. <i>Nitzschia longissima</i> , girdle view . . . . .	309
“ 13. <i>Surirella</i> , valve view . . . . .	309
“ 14. <i>Surirella</i> , girdle view . . . . .	309
“ 15. <i>Melosira</i> , valve view . . . . .	310
“ 16. <i>Melosira</i> , girdle view . . . . .	310
“ 17. <i>Melosira auxospore</i> . . . . .	310
“ 18. <i>Cyclotella</i> , valve view . . . . .	310
“ 19. <i>Cyclotella</i> , girdle view . . . . .	310
“ 20. <i>Stephanodiscus</i> , valve view . . . . .	310
“ 21. <i>Stephanodiscus</i> , girdle view . . . . .	310

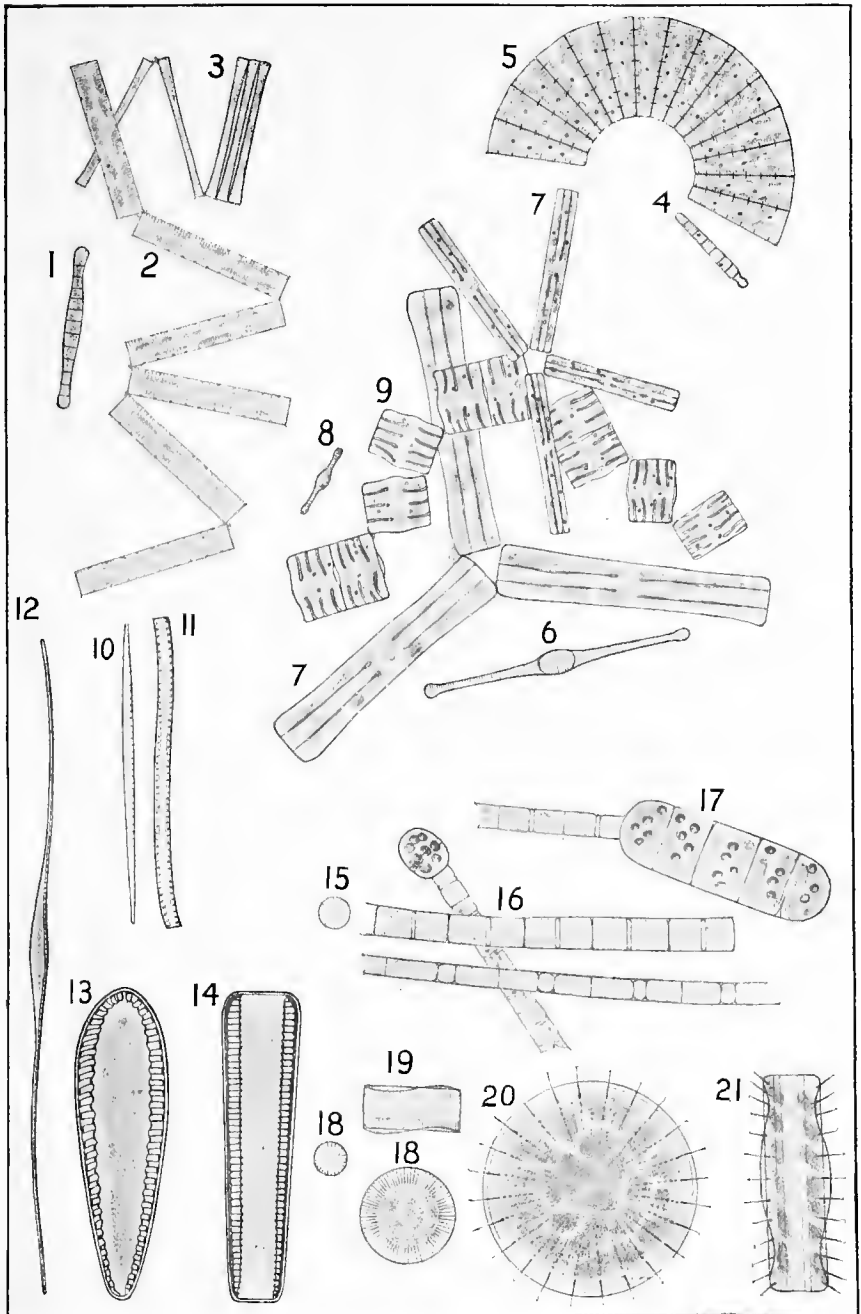



PLATE IV.

*SCHIZOMYCETES. CYANOPHYCEÆ.*

## PLATE IV

### SCHIZOMYCETES

Magnification 500 diameters

	PAGE
Fig. 1. Leptothrix.....	312
“ 2. Cladotrix, showing false branching.....	312
“ 3. Beggiatoa.....	313
“ 4. Crenothrix. A, filament enclosed in sheath. B, filament with sheath removed, showing liberation of spores.....	313

### CYANOPHYCEÆ

Magnification 500 diameters

Fig. 5. Chroococcus.....	318
“ 6. Gloeocapsa.....	318
“ 7. Aphanocapsa.....	319
“ 8. Microcystis.....	319
“ 9. Clathrocystis.....	319
“ 10. Coelosphaerium.....	319
“ 11. Merismopedia.....	319
“ 12. Nostoc.....	321
“ 13. Anabæna flos-aquæ.....	321
“ 14. Anabæna circinalis.....	321

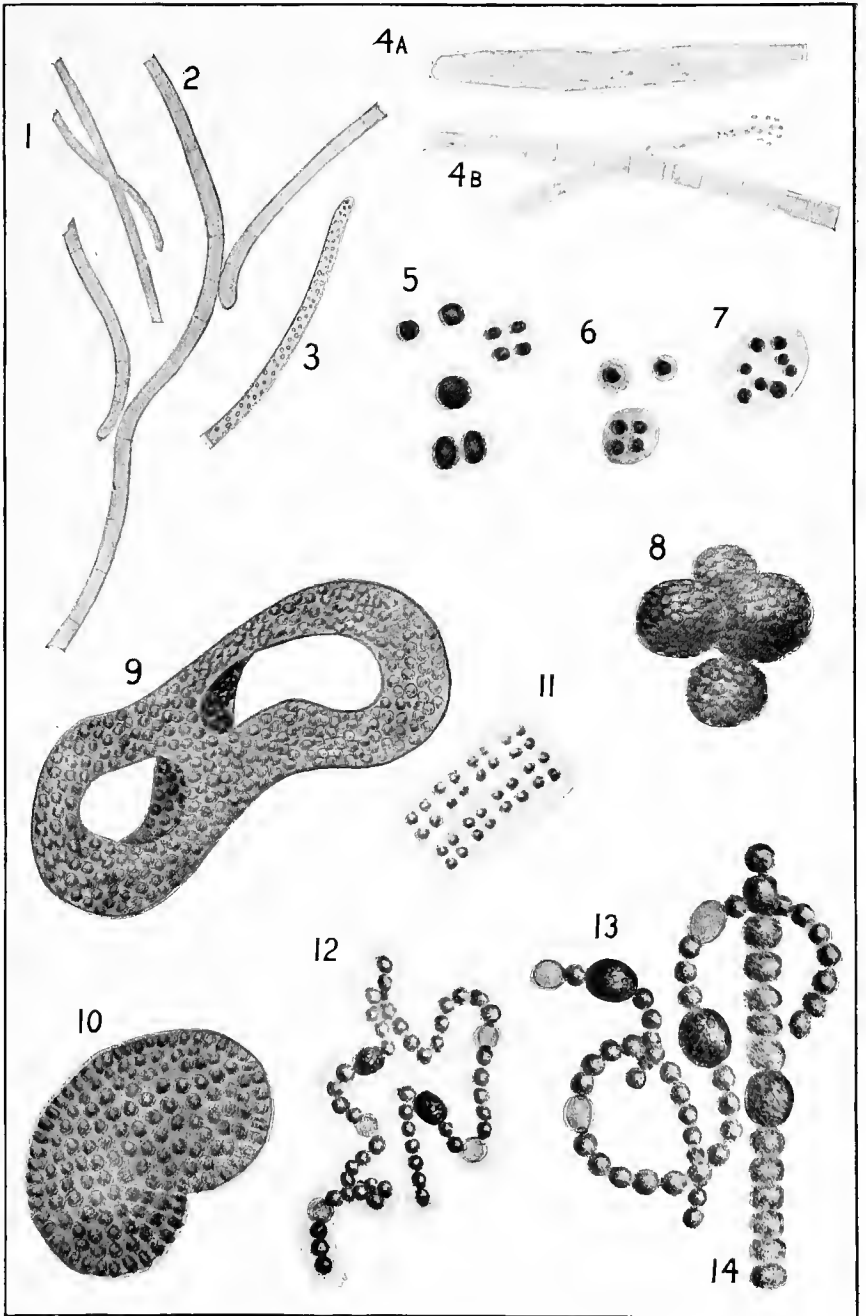



PLATE V.

*CYANOPHYCEÆ. CHLOROPHYCEÆ.*

## PLATE V

*Bl. 920m.*

### CYANOPHYCEÆ

Magnification 500 diameters

	PAGE
Fig. 1. Sphærozyga.....	321
“ 2. Cyindrospermum.....	322
“ 3. Aphanizomenon.....	322
“ 4. Oscillaria.....	322
“ 5. Lyngbya.....	322
“ 6. Microcoleus.....	323
“ 7. Scytonema.....	323
“ 8. Sirospira.....	323
“ 9. Rivularia, a single filament.....	324

*Green*

### CHLOROPHYCEÆ

Magnification 500 diameters

Fig. 10. Glœocystis.....	327
“ 11. Palmella.....	327
“ 12. Tetraspora.....	327

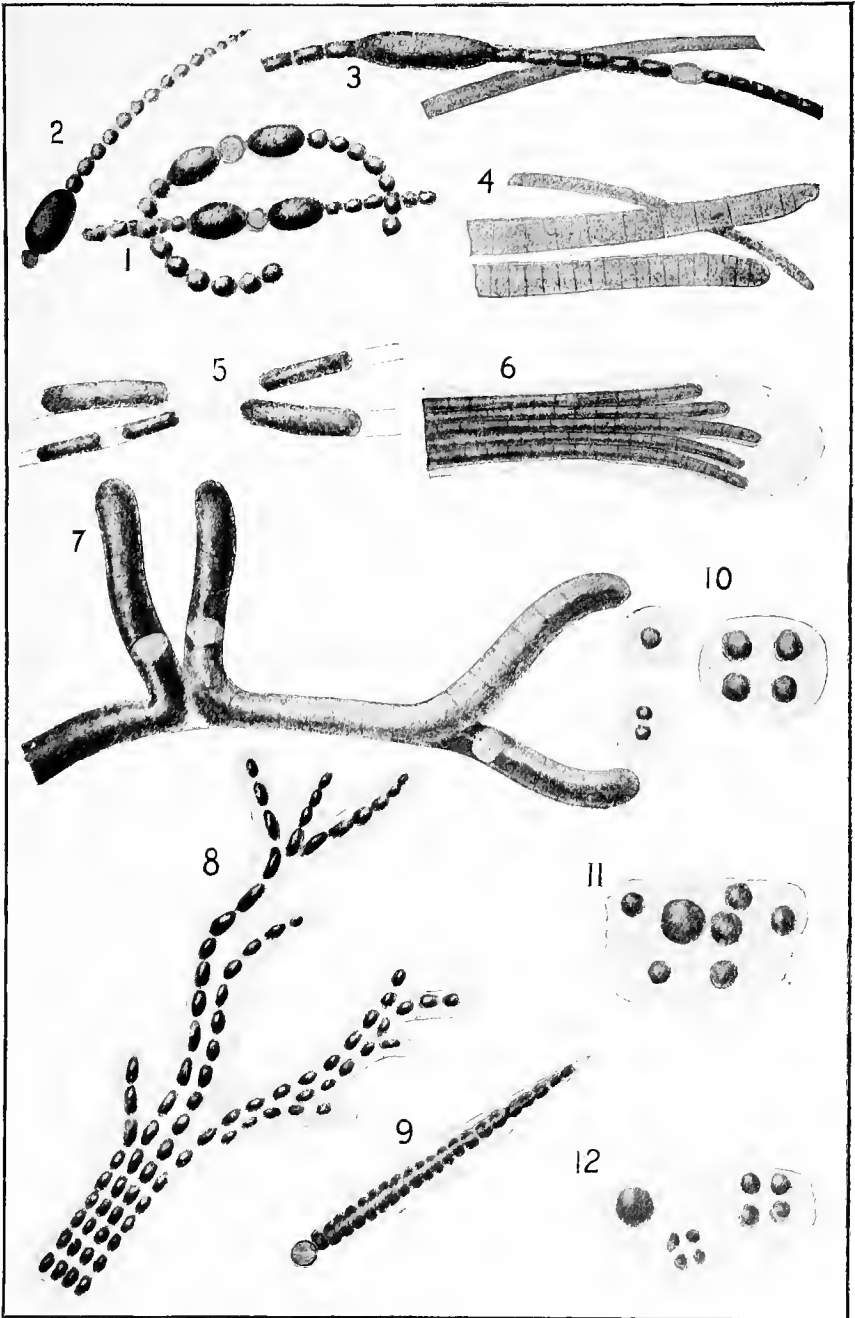



PLATE VI.

*CHLOROPHYCEÆ.*

PLATE VI  
CHLOROPHYCEÆ

*Green*

Magnification 500 diameters (except Fig. 9)

		PAGE
Fig.	1. Botryococcus.....	328
"	2. Raphidium.....	328
"	3. Dictyosphærium.....	328
"	4. Nephrocytium.....	328
"	5. Dimorphococcus.....	328
"	6. Protococcus.....	328
"	7. Polyedrium.....	329
"	8. Scenedesmus.....	329
"	9. Hydrodictyon. $\times 250$ .....	329
"	10. Ophiocytium.....	329
"	11. Pediastrum.....	329
"	12. Sorastrum.....	330

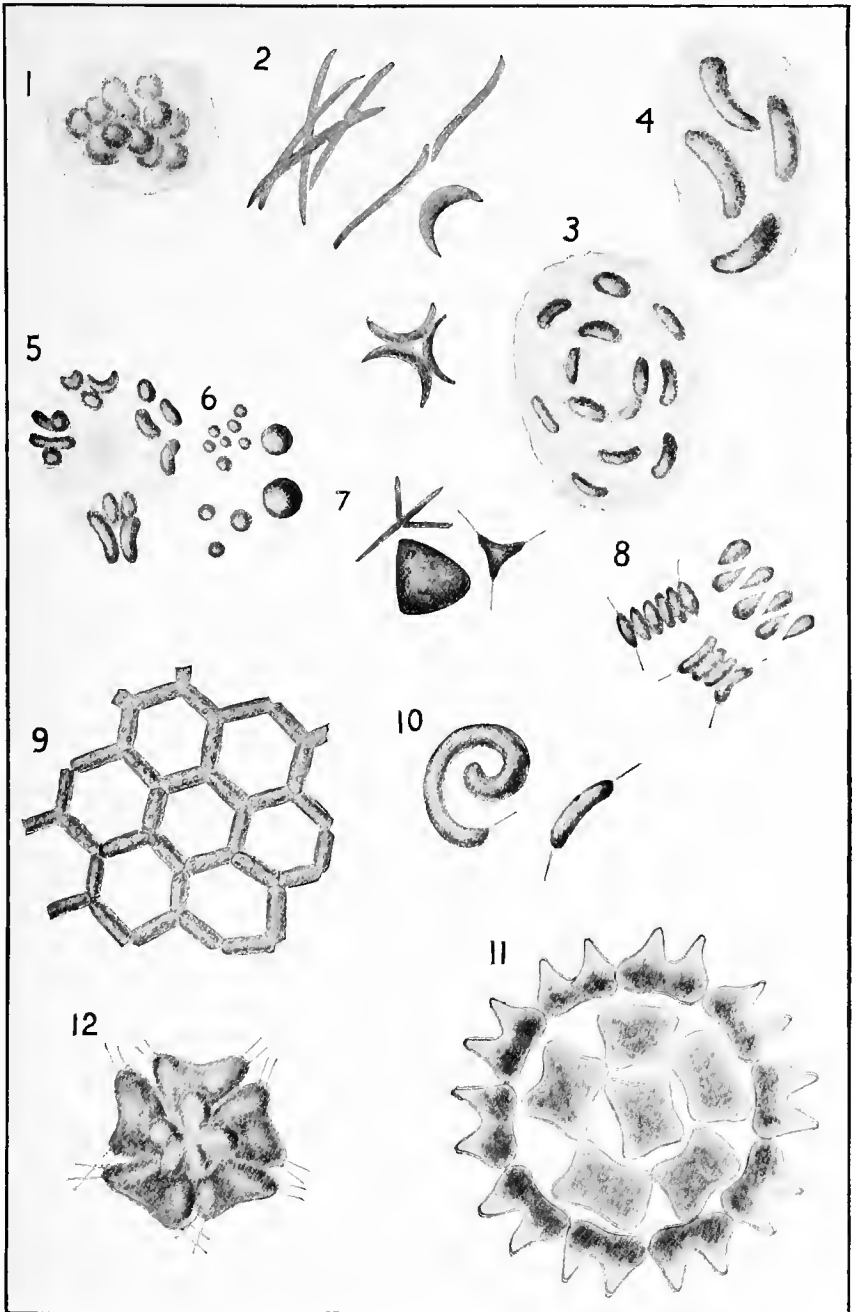



PLATE VII.

*CHLOROPHYCÆ.*

## PLATE VII

### CHLOROPHYCEÆ

*9 new*

		PAGE
Fig.	1. Cœlastrum. ×500.....	330
"	2. Staurogenia. ×500. ....	330
"	3. Volvox. ×100.....	331
"	4. Eudorina. ×250.....	331
"	5. Pandorina. ×250.....	331
"	6. Gonium. <i>a</i> , top view. <i>b</i> , side view. ×500.....	332
"	7. Penium. ×250.....	333
"	8. Closterium Dianæ. ×250.....	333
"	9. Closterium Ehrenbergii. ×250.....	333
"	10. Closterium subtile. ×250.....	333
"	11. Docidium. ×250.....	333
"	12. Cosmarium. ×250.....	333
"	13. Tetmemorus. ×250.....	334

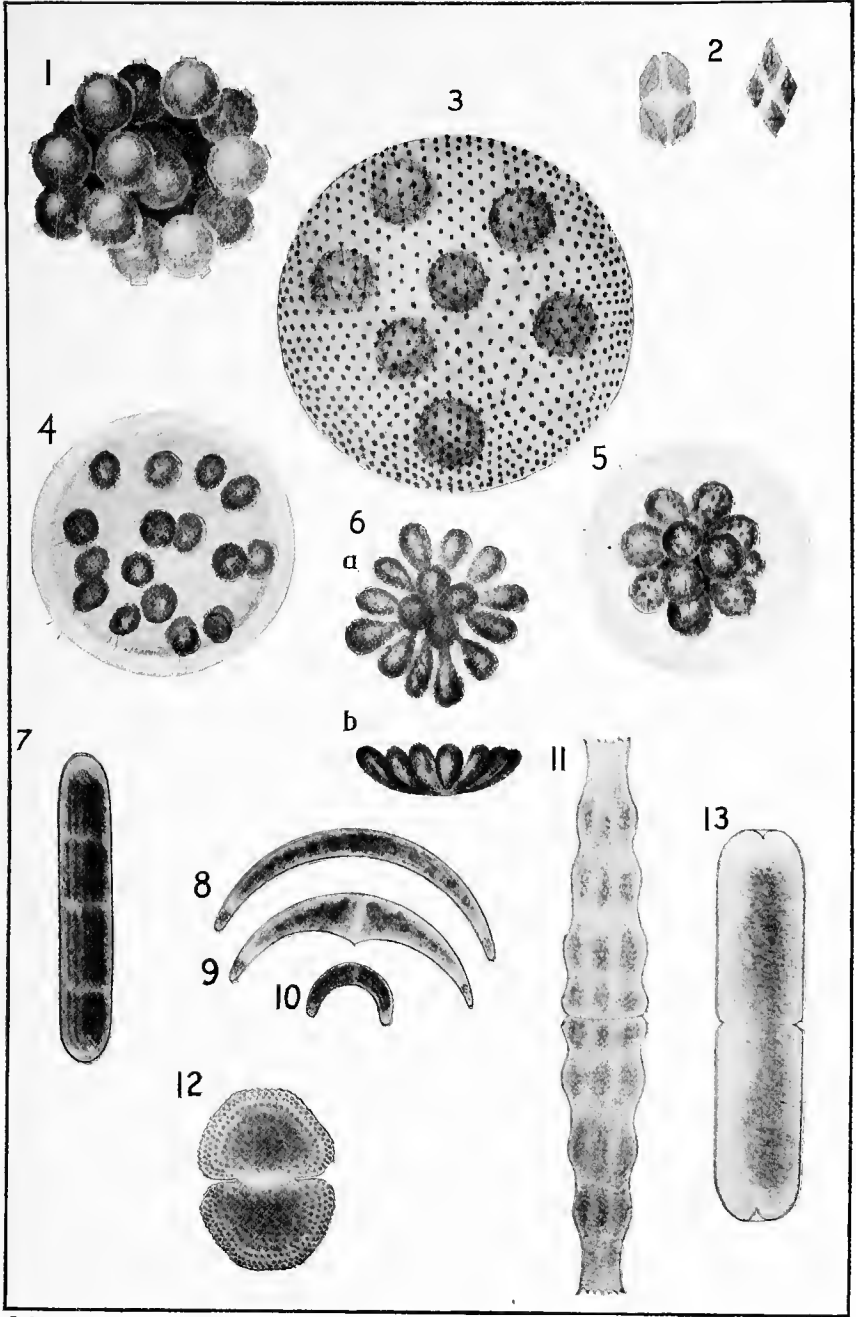



PLATE VIII.

*CHLOROPHYCEÆ.*

## PLATE VIII

### CHLOROPHYCEÆ

Magnification 250 diameters

	PAGE
Fig. A. Cosmarium, showing division.....	333
Figs. B, C, D, E, and F. Cosmarium, showing conjugation, formation of zygospore and germination of the spore.....	333
Fig. 1. Xanthidium armatum.....	334
“ 2. Xanthidium antilopæum. <i>a</i> , front view. <i>b</i> , lateral view. <i>c</i> , end view	334
“ 3. Arthrodesmus. <i>a</i> , front view. <i>b</i> , end view.....	334
“ 4. Euastrum. <i>a</i> , front view. <i>b</i> , lateral view.....	334
“ 5. Micrasterias.....	334
“ 6. Staurastrum magnum. <i>a</i> , front view. <i>b</i> , end view.....	334
“ 7. Staurastrum macrocerum. <i>a</i> , front view. <i>b</i> , end view.....	334

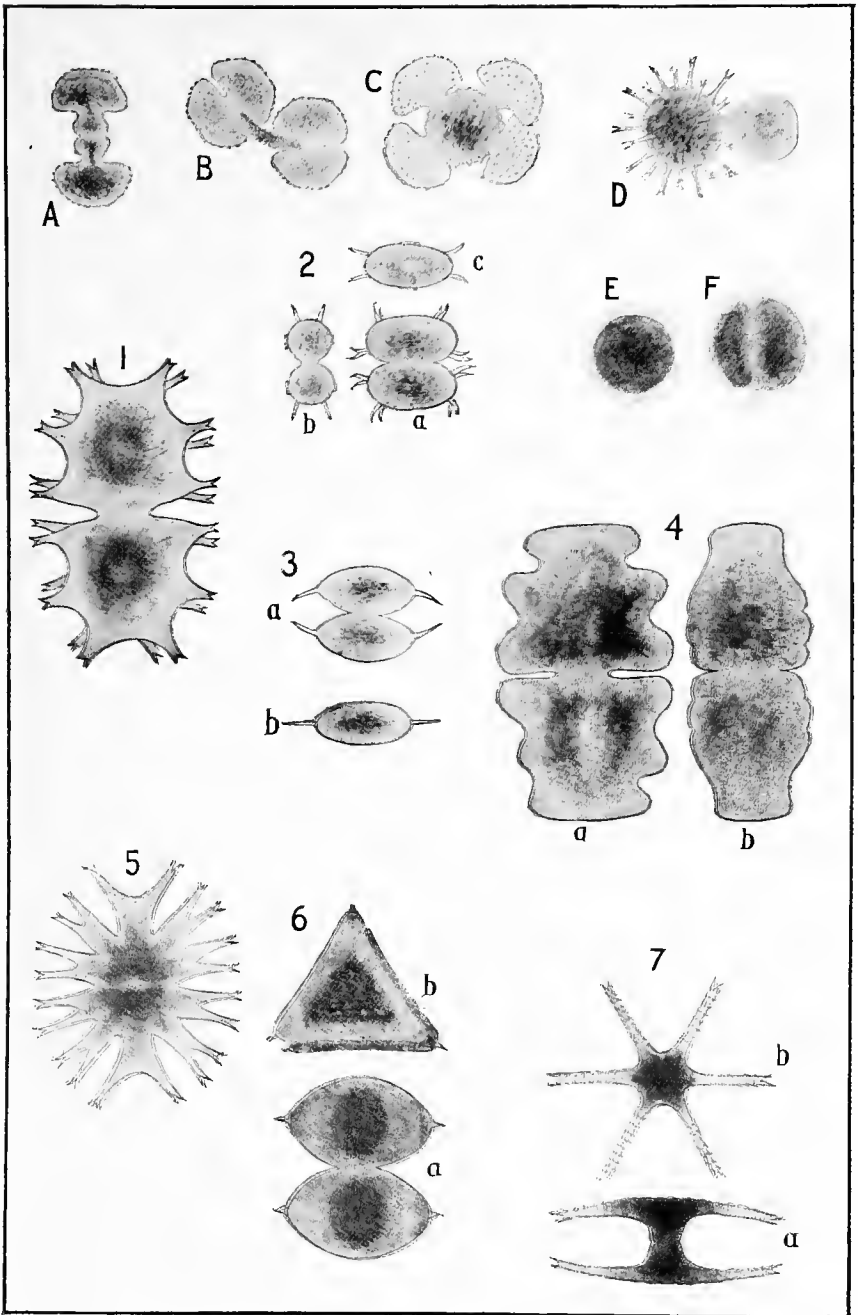



PLATE IX.

*CHLOROPHYCEÆ.*

# PLATE IX

## CHLOROPHYCEÆ

*green*

	PAGE
Fig. 1. Hyalotheca. <i>a</i> , filament. <i>b</i> , end view. $\times 500$ .....	334
“ 2. Desmidium. <i>a</i> , filament. <i>b</i> , end view. $\times 500$ .....	336
“ 3. Sphærozosma. <i>a</i> , filament. <i>b</i> , end view. $\times 500$ .....	336
“ 4. Spirogyra. $\times 125$ .....	336
“ 5. Spirogyra, conjugated form, showing spores. $\times 125$ .....	336
“ 6. Zygnema. $\times 125$ .....	337
“ 7. Vaucheria. $\times 100$ .....	337
“ 8. Conferva. $\times 125$ .....	338
“ 9. Cladophora. $\times 75$ .....	338
“ 10. Ulothrix. $\times 125$ .....	338

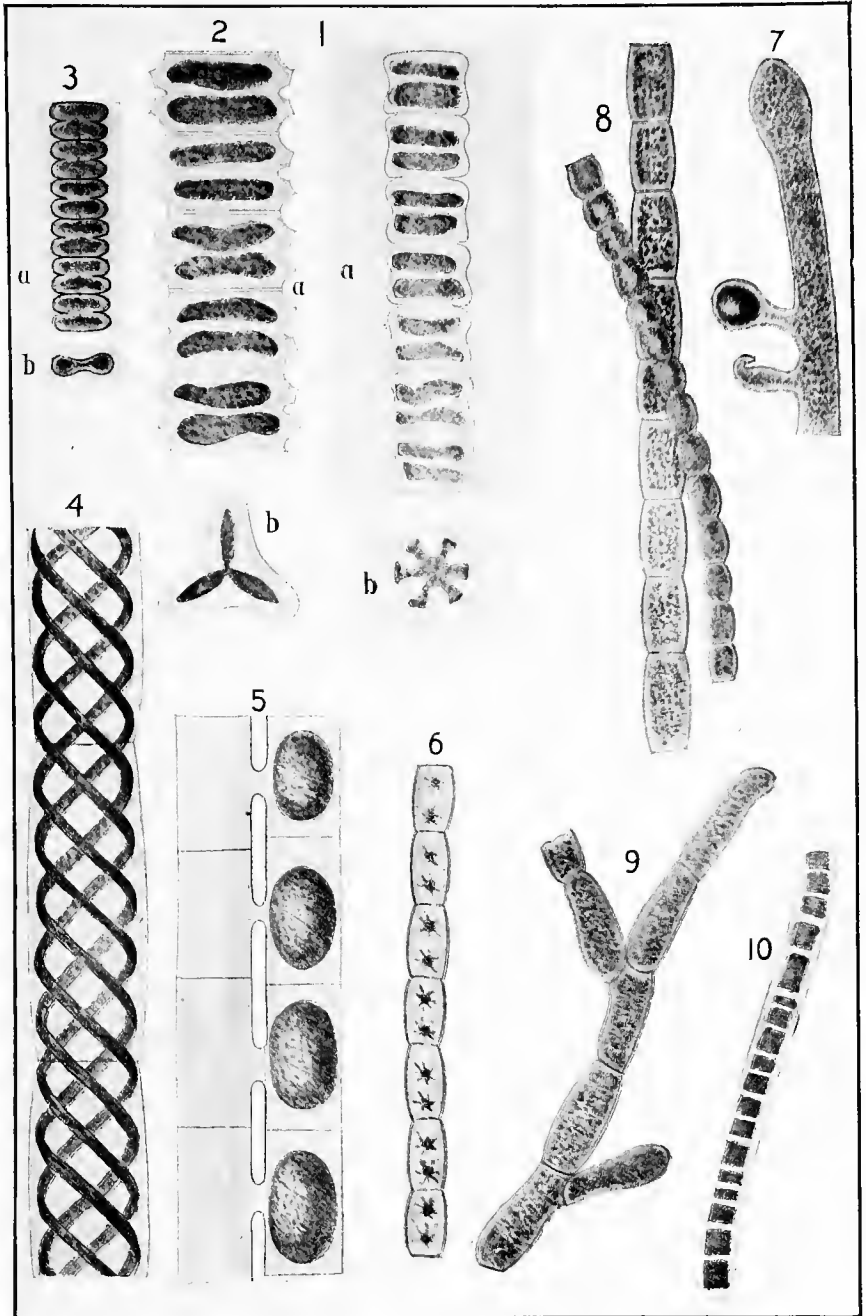



PLATE X.

*CHLOROPHYCEÆ. FUNGI.*

## PLATE X

### CHLOROPHYCEÆ

	PAGE
Fig. 1. <i>Draparnaldia</i> . $\times 125$ .....	339
“ 2. <i>Stigeoclonium</i> . $\times 125$ .....	339
“ 3. <i>Chætophora</i> . $\times 125$ .....	339

### FUNGI

Fig. 4. <i>Saccharomyces</i> . $\times 500$ .....	342
“ 5. Mold hyphæ. $\times 250$ .....	342
“ 6. <i>Penicillium</i> . $\times 250$ .....	342
“ 7. <i>Aspergillus</i> . $\times 250$ .....	342
“ 8. <i>Mucor</i> . $\times 250$ .....	343

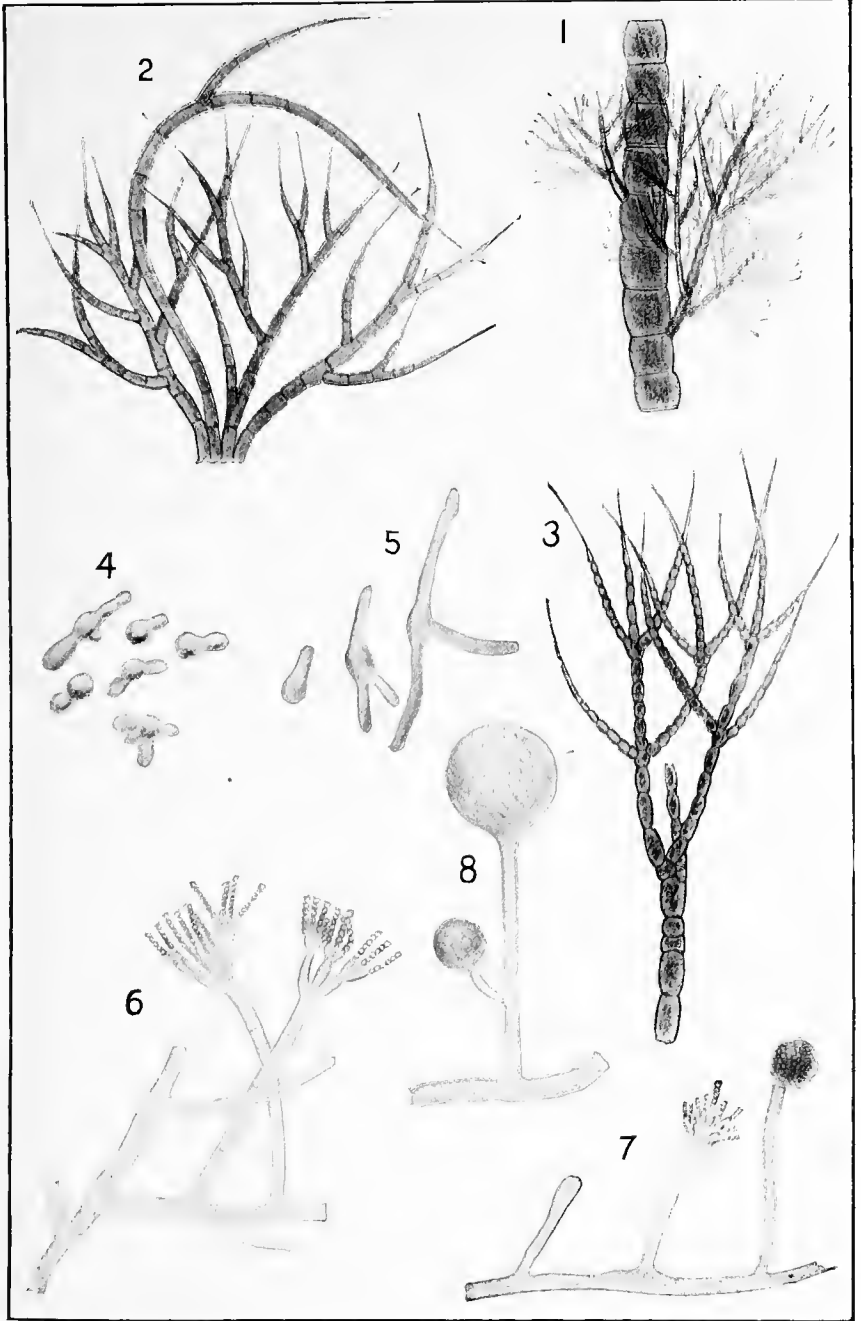



PLATE XI.

*FUNGI. PROTOZOA.*

## PLATE XI

### FUNGI

	PAGE
Fig. 1. Saprolegnia. $\times 250$ .....	343
“ 2. Achlya. $\times 250$ .....	343
“ 3. Leptomitus. $\times 500$ .....	343

### PROTOZOA

Fig. 4. Amoeba. $\times 250$ .....	348
“ 5. Arcella, lateral view. $\times 250$ .....	349
“ 6. Arcella, interior view. $\times 250$ .....	349
“ 7. Diffugia. $\times 250$ .....	349
“ 8. Euglypha. $\times 250$ .....	349
“ 9. Trinema. $\times 250$ .....	350
“ 10. Actinophrys. $\times 250$ .....	350

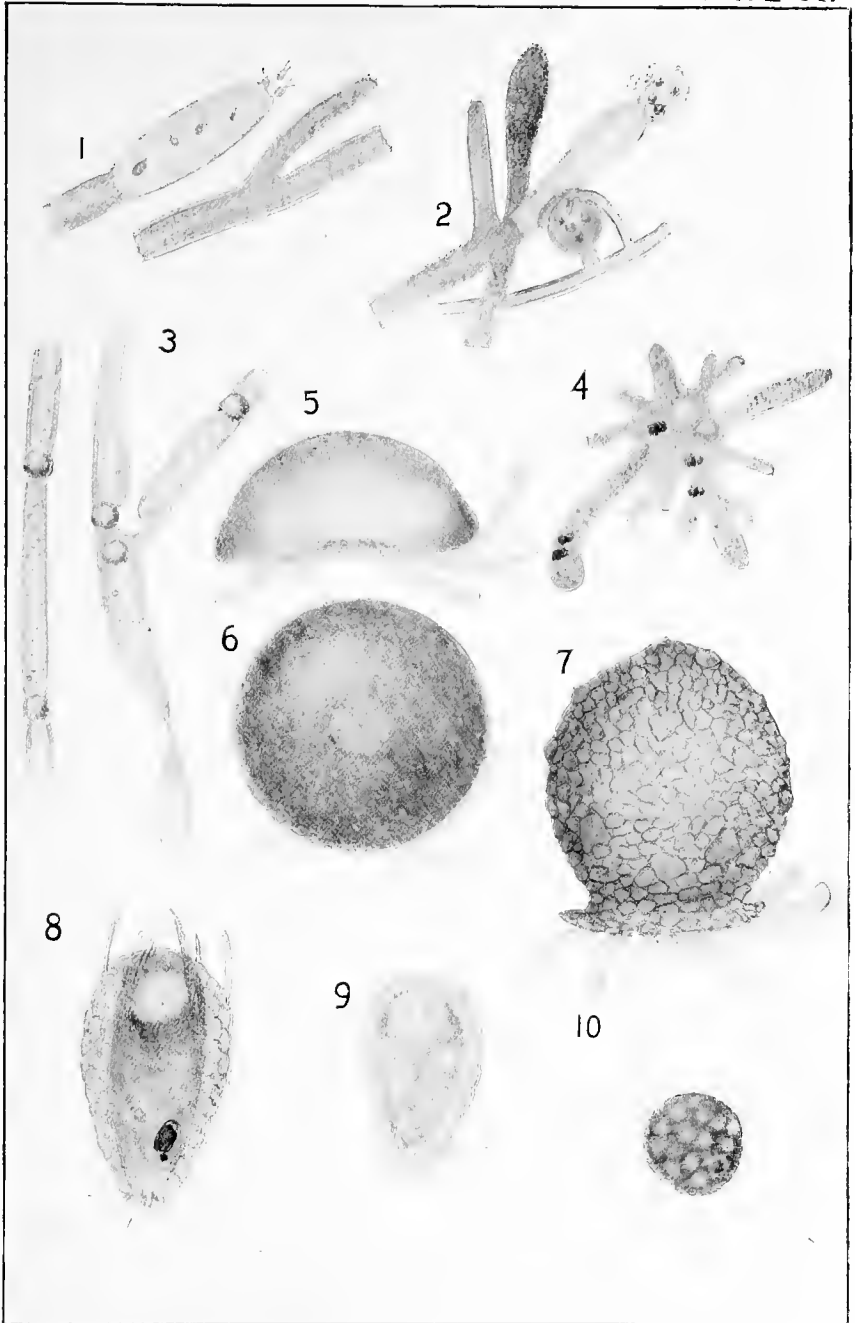



PLATE XII.

*PROTOZOA.*

## PLATE XII

### PROTOZOA .

		PAGE
Fig.	1. <i>Cercomonas</i> . $\times 500$ .....	351
“	2. <i>Monas</i> . $\times 500$ .....	352
“	3. <i>Anthophysa</i> . $\times 500$ .....	352
“	4. <i>Cœlomonas</i> . $\times 500$ .....	352
“	5. <i>Raphidomonas</i> . $\times 500$ .....	352
“	6. <i>Euglena</i> . $\times 500$ .....	353
“	7. <i>Trachelomonas</i> . $\times 500$ .....	353
“	8. <i>Phacus</i> . $\times 500$ .....	353
“	9. <i>Synura</i> . $\times 500$ .....	354
“	10. <i>Uvella</i> . $\times 500$ .....	354
“	11. <i>Syncrypta</i> . $\times 500$ .....	354
“	12. <i>Uroglena</i> . $\times 250$ .....	354
“	13. <i>Uroglena</i> ; showing division of the monads. $\times 1000$ .....	354

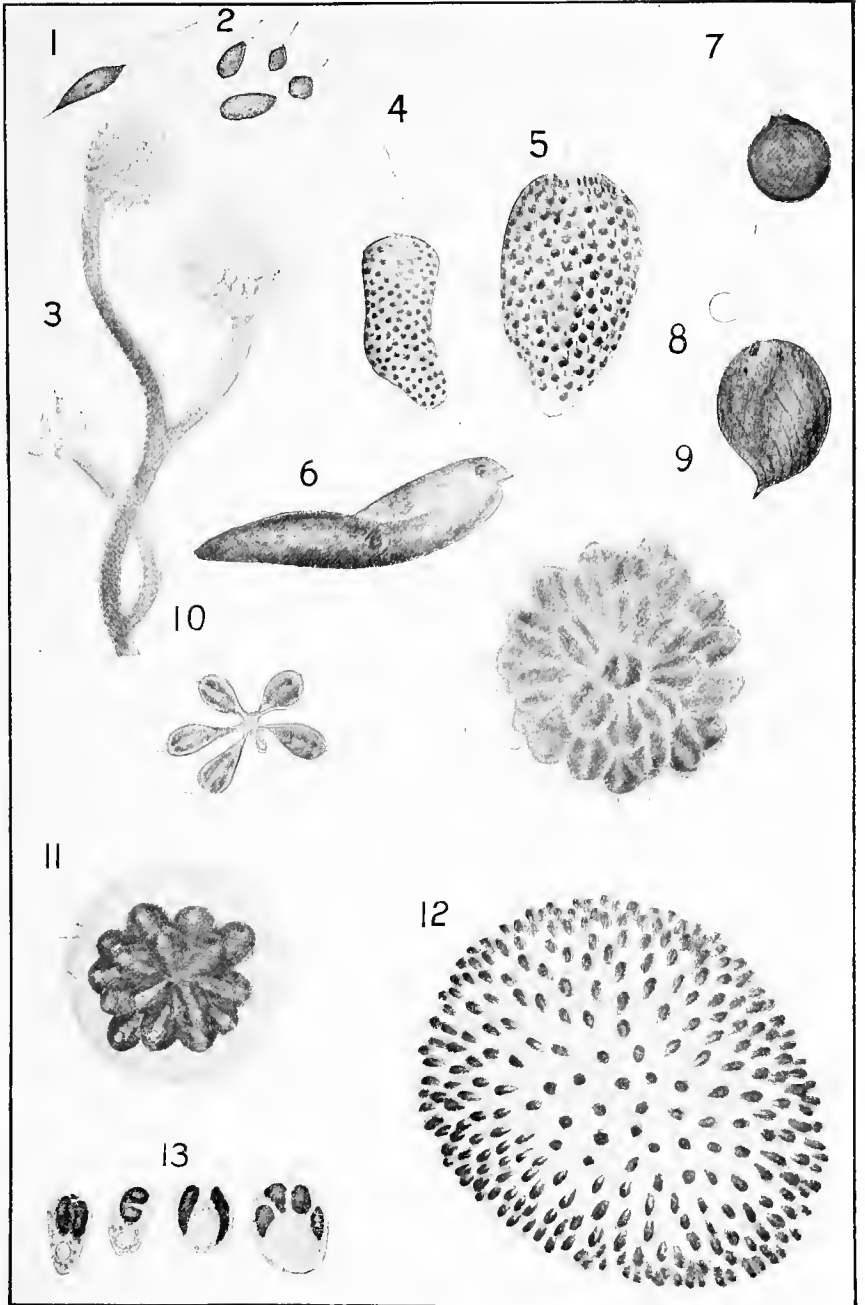



PLATE XIII.

*PROTOZOA.*

## PLATE XIII

### PROTOZOA

	PAGE
Fig. 1. Dinobryon. $\times 500$ .....	355
“ 2. Cryptomonas. $\times 500$ .....	355
“ 3. Mallomonas. $\times 500$ .....	355
“ 4. Chlamydomonas. $\times 1000$ .....	355
“ 5. Peridinium. $\times 500$ .....	359
“ 6. Ceratium. $\times 250$ .....	357
“ 7. Glenodinium. $\times 500$ .....	357
“ 8. Euplotes. $\times 250$ .....	358
“ 9. Halteria. $\times 500$ .....	358
“ 10. Vorticella. $\times 250$ .....	359
“ 11. Epistylis. $\times 250$ .....	359
“ 12. Tintinnus. $\times 250$ .....	360

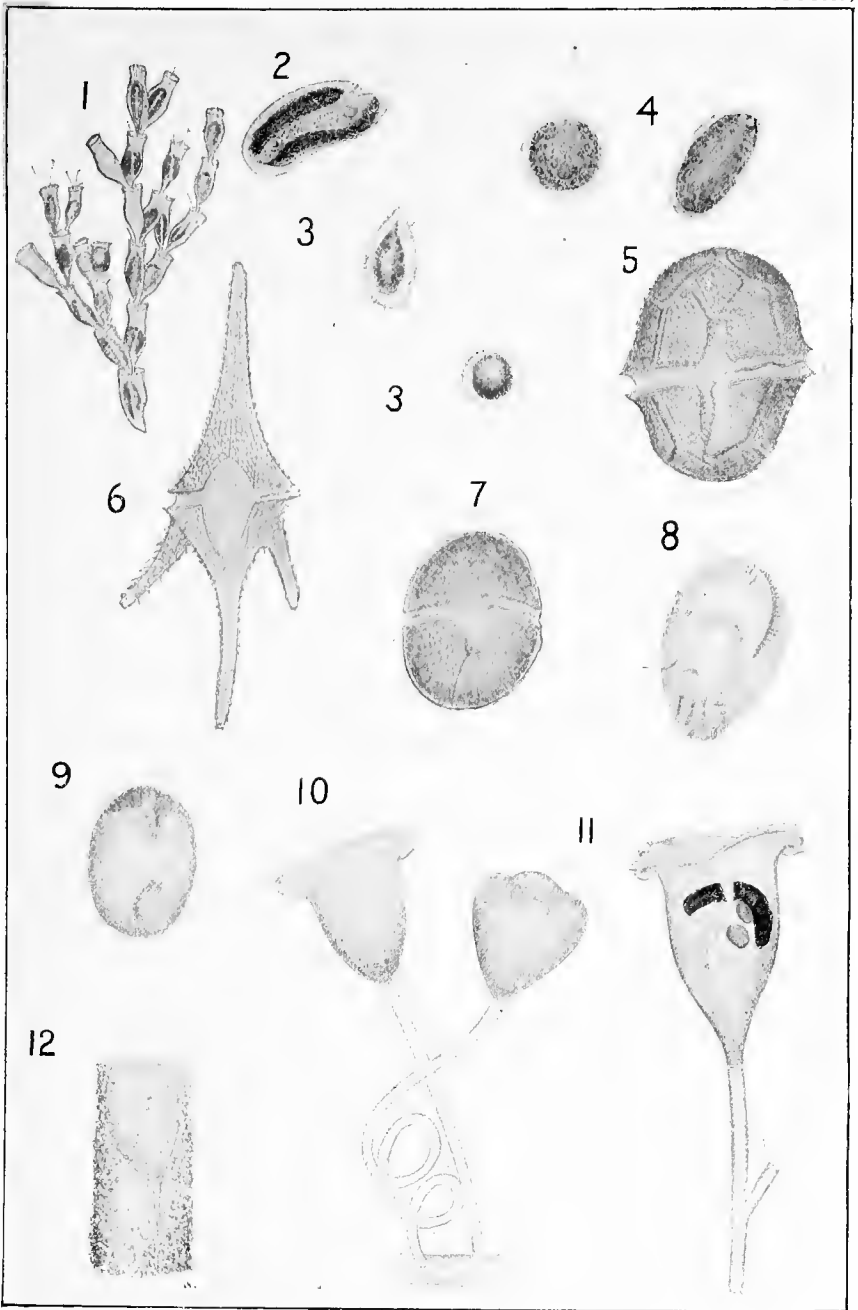



PLATE XIV.

*PROTOZOA.*

## PLATE XIV

### PROTOZOA

	PAGE
Fig. 1. Codonella. $\times 500$ .....	360
“ 2. Stentor. $\times 50$ .....	360
“ 3. Bursaria. $\times 100$ .....	361
“ 4. Paramæcium. $\times 250$ .....	361
“ 5. Nassula. $\times 250$ .....	362
“ 6. Coleps. $\times 500$ .....	362
“ 7. Enchelys. $\times 500$ .....	362
“ 8. Trachelocerca. $\times 500$ .....	362
“ 9. Pleuronema. $\times 500$ .....	362

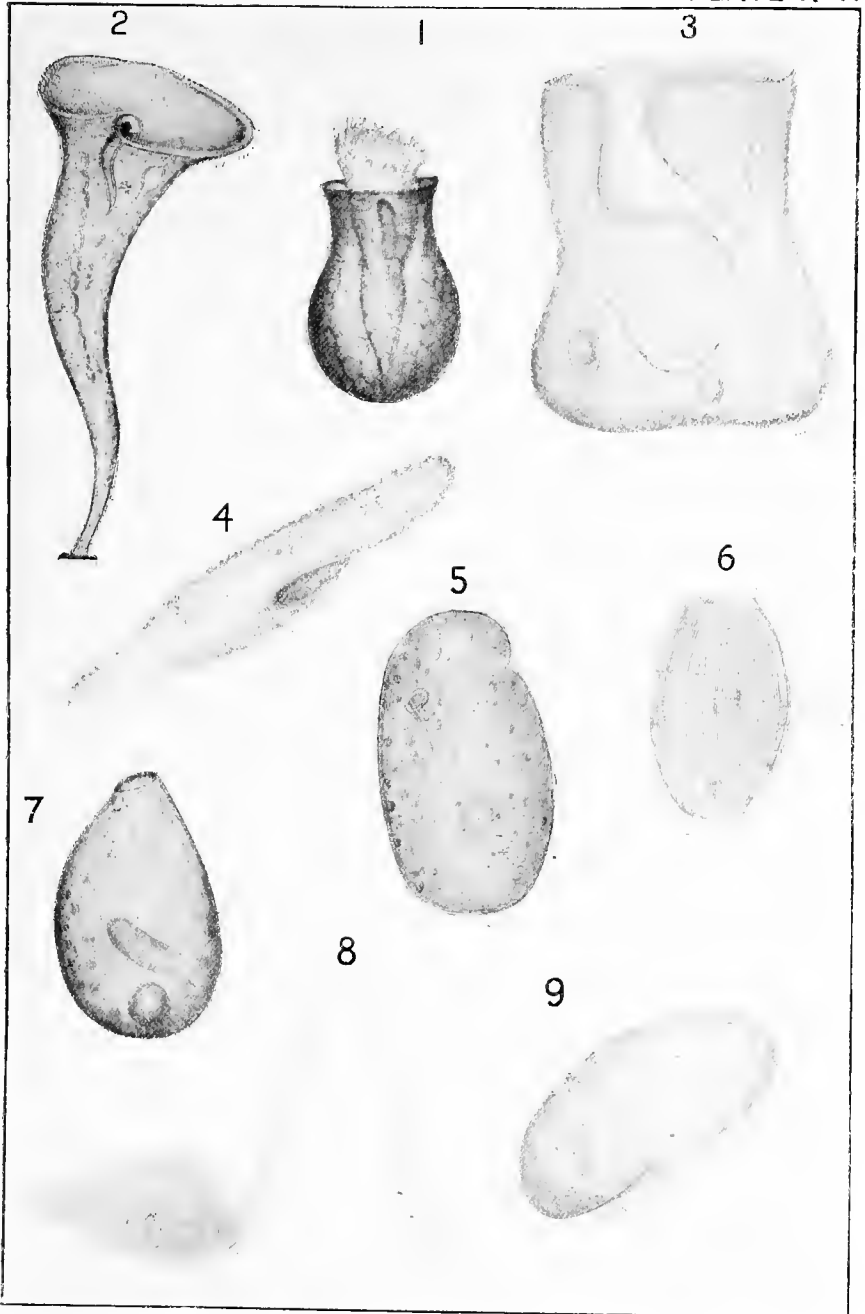



PLATE XV.

*PROTOZOA. ROTIFERA.*

## PLATE XV

### PROTOZOA

	PAGE
Fig. 1. Colpidium. $\times 500$ .....	363
“ 2. Acineta. $\times 500$ .....	363

### ROTIFERA

Fig. 3. Floscularia. $\times 25$ .....	367
“ 4. Melicerta. $\times 25$ .....	368
“ 5. Conochilus. $\times 100$ .....	368
“ 6. Rotifer. $\times 100$ .....	368
“ 7. Microcodon. $\times 150$ .....	369
“ 8. Asplanchna. $\times 150$ .....	369

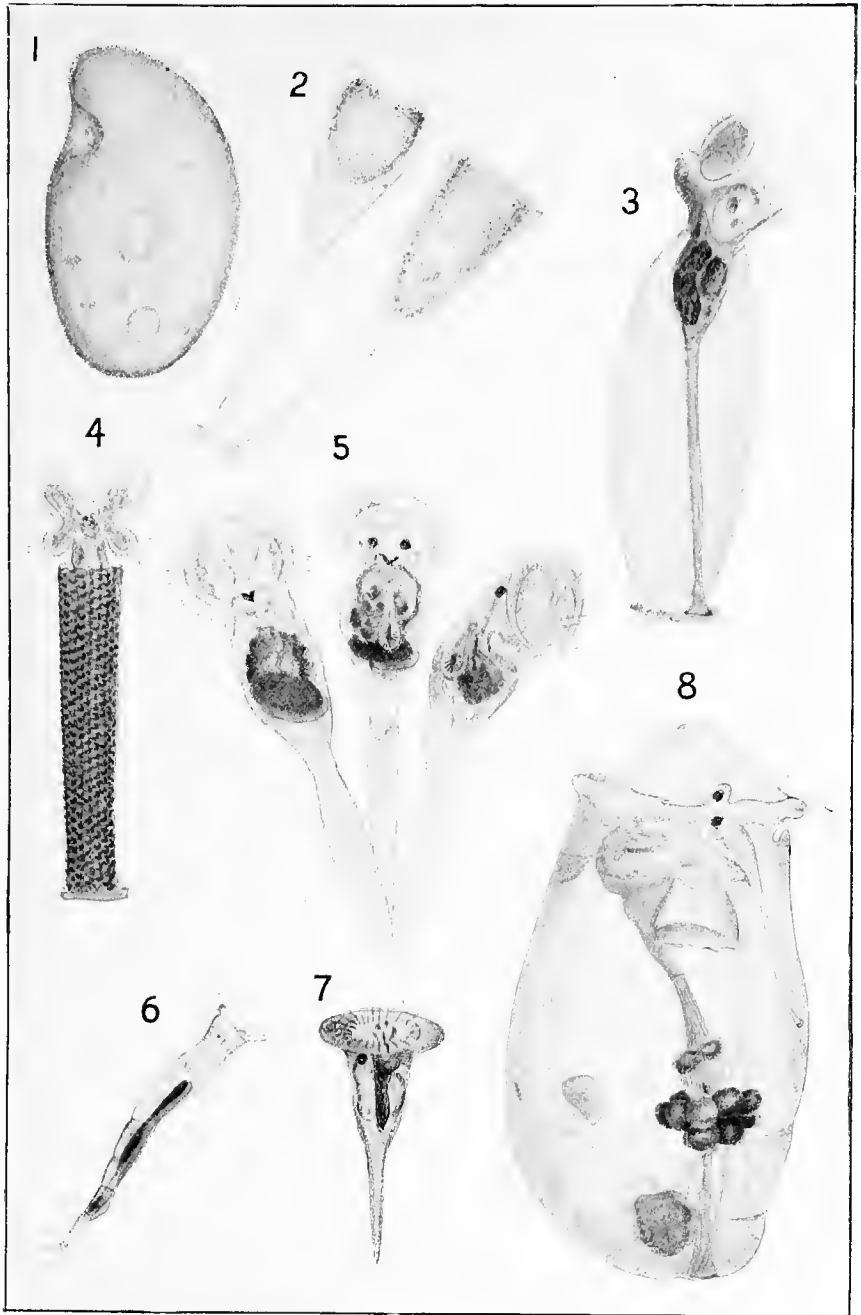



PLATE XVI.

*ROTIFERA.*

## PLATE XVI

- Figs. A to E. Diagrams of Trochal Disc. (After Bourne.)  
 A, Microcodon. B, Stephanoceros. C, Hypothetical form intermediate between Microcodon and Philodina. D, Philodina. E, Brachionus.
- Figs. F to I. Diagrams showing Structure of the Foot. (After Hudson and Gosse.)  
 F, Rhizotic foot (Floscularia). G, Rhizotic foot (Melicerta). H, Bdelloidic foot (Rotifer). I, Scirtopodic foot (Pedalion).
- Figs. J to P. Diagrams showing Forms of Trophi. (After Hudson and Gosse.)  
 J, Malleate. K, Sub-malleate. L, Forcipitate. M, Incudate. N, Uncinate. O, Ramate. P, Malleoramate.

---

### ROTIFERA

	PAGE
Fig. 1. Synchæta. $\times 100$ .....	369
“ 2. Polyarthra. $\times 200$ .....	370
“ 3. Triarthra. $\times 150$ .....	370
“ 4. Diglena. $\times 150$ .....	370
“ 5. Mastigocerca. $\times 150$ .....	371

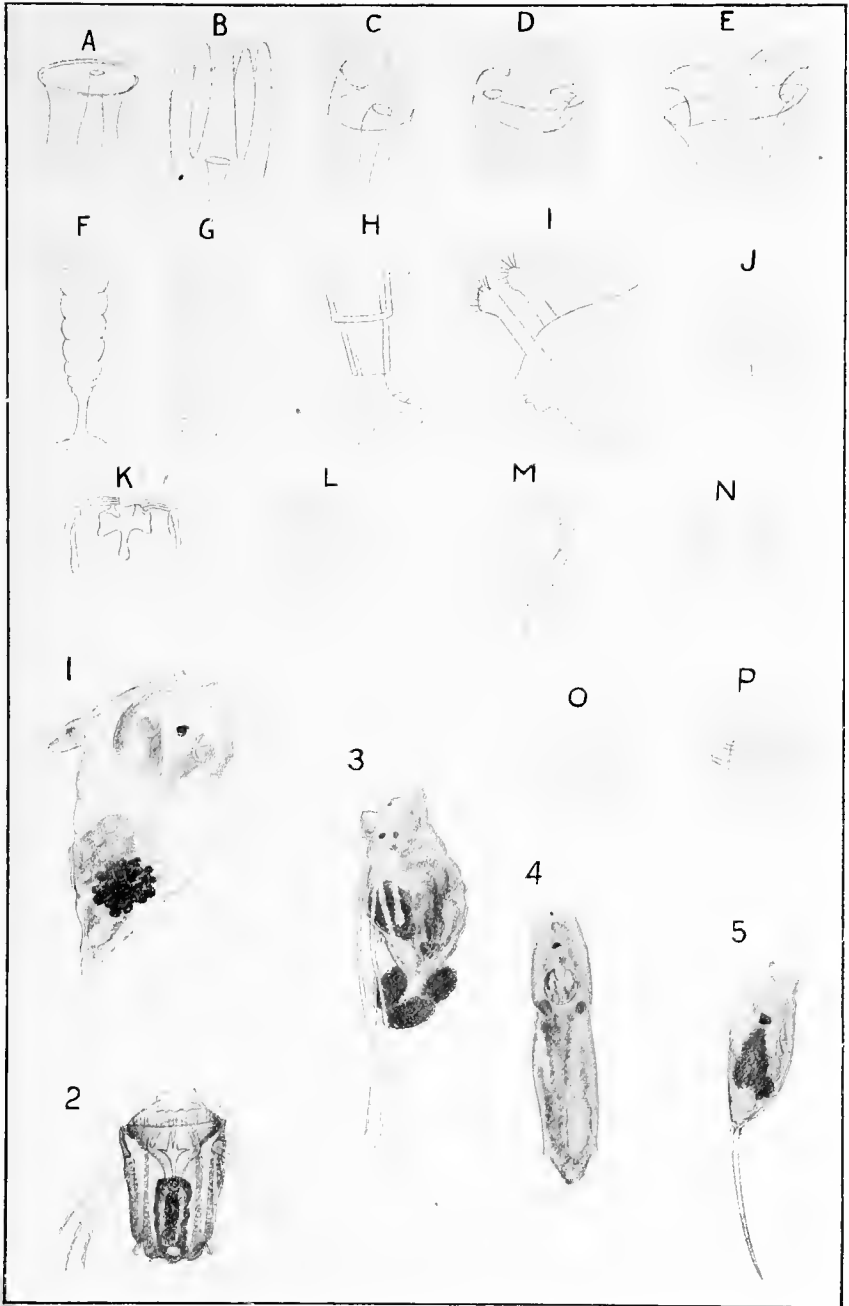



PLATE XVII.

*ROTIFERA. CRUSTACEA.*

## PLATE XVII

### ROTIFERA

	PAGE
Fig. 1. <i>Brachionus</i> . $\times 200$ .....	371
“ 2. <i>Anuræa cochlearis</i> . <i>A</i> , dorsal view, <i>B</i> , side view. $\times 150$ .....	371
“ 3. <i>Anuræa aculeata</i> . $\times 150$ .....	371
“ 4. <i>Notholca</i> . $\times 200$ .....	371

### CRUSTACEA

Fig. 5. <i>Cyclops</i> . $\times 25$ .....	374
“ 6. <i>Diaptomus</i> . $\times 25$ .....	375
“ 7. <i>Canthocamptus</i> . $\times 25$ .....	375
“ 8. <i>Cypris</i> . $\times 25$ .....	375
“ 9. <i>Daphnia</i> . $\times 25$ .....	376
“ 10. <i>Bosmina</i> . $\times 25$ .....	376

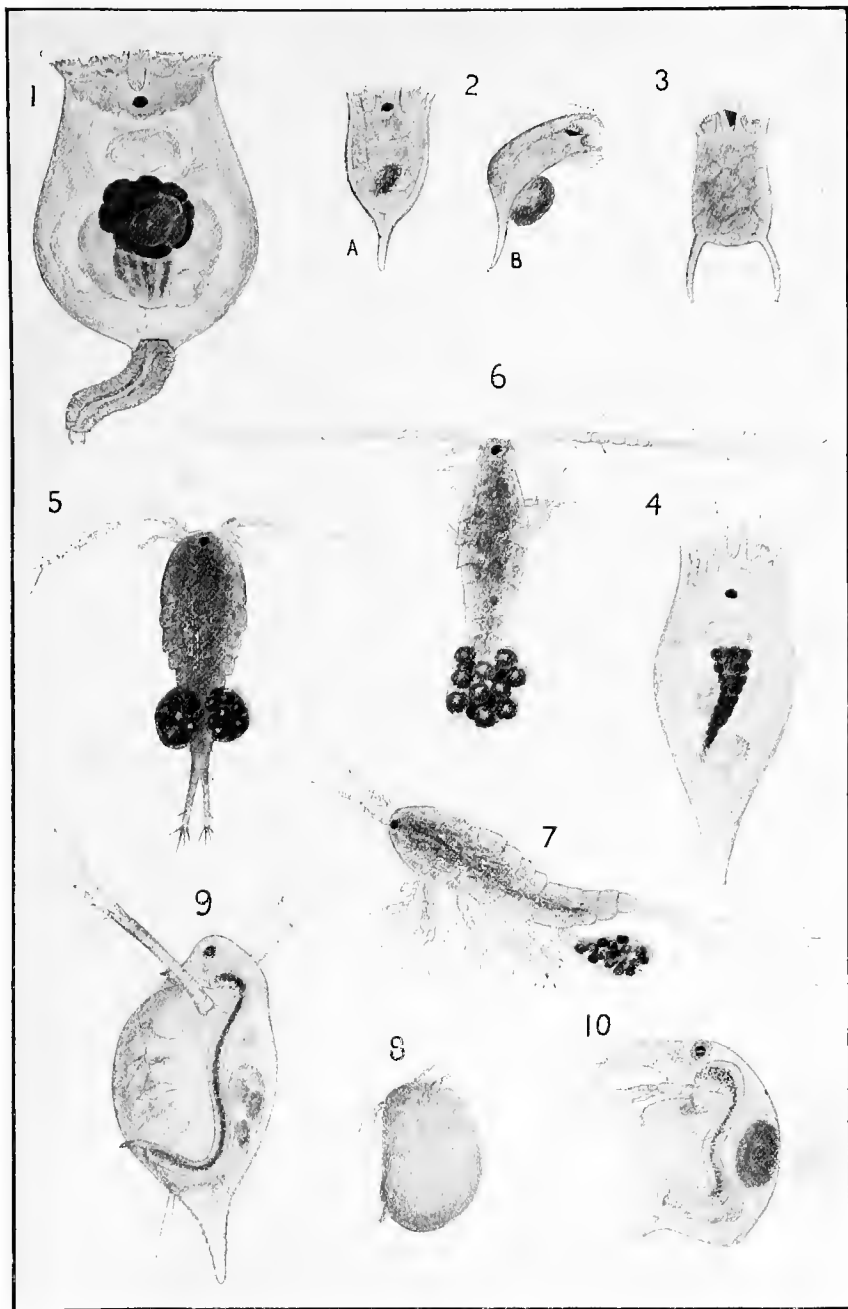



PLATE XVIII.

*CRUSTACEA. BRYOZOA. SPONGIDÆ.*

## PLATE XVIII

### CRUSTACEA

	PAGE
Fig. 1. Sida. $\times 25$ .....	376
“ 2. Chydorus. $\times 25$ .....	376
“ 3. Branchipus. $\times 2$ .....	376

### BRYOZOA

Fig. 4. Fredericella. $\times 5$ .....	379
“ 5. Paludicella. $\times 5$ .....	379
“ 6. Statoblast of Plumatella. $\times 25$ .....	379
“ 7. Statoblast of Pectinatella. $\times 25$ .....	379

### SPONGIDÆ

Fig. 8. Spongilla. $\times 1$ .....	381
“ 9. Sponge spicules (skeleton spicules). $\times 150$ .....	381

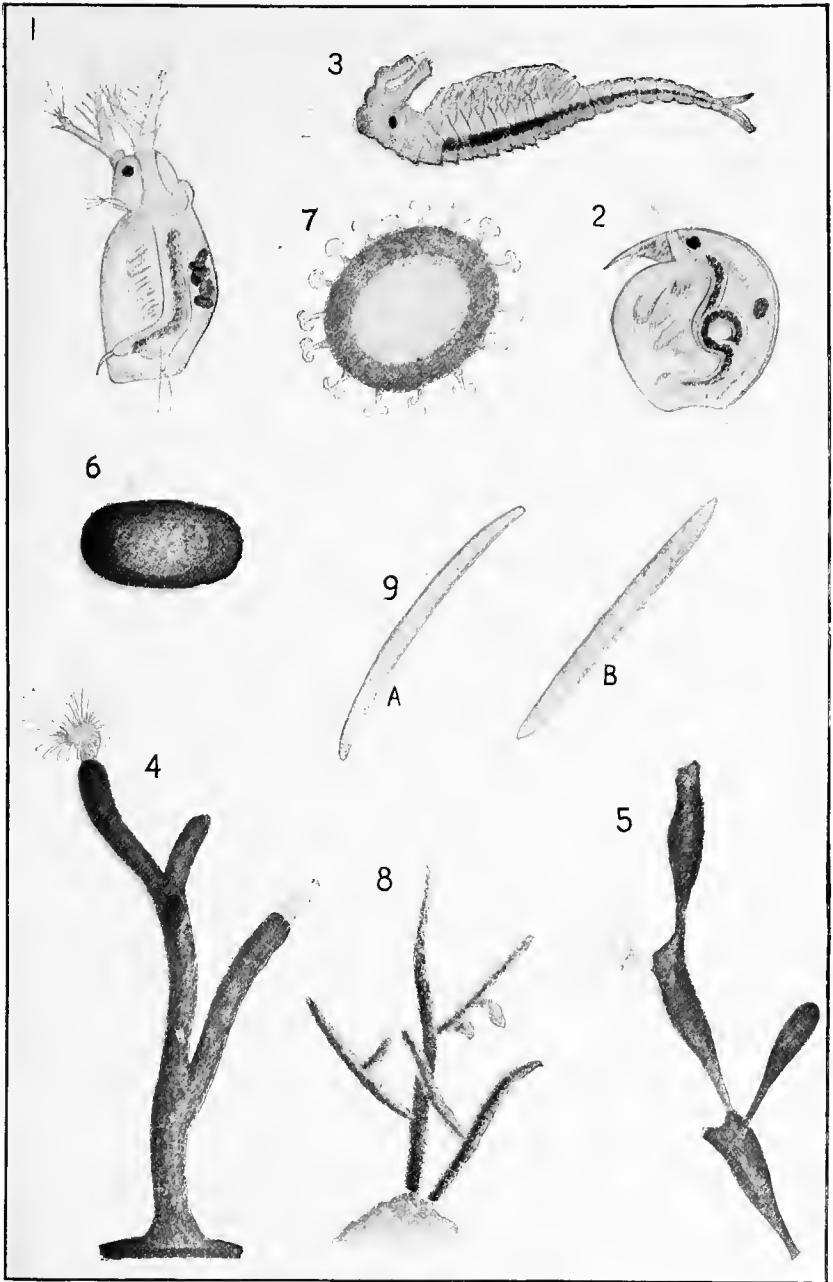



PLATE XIX.

*MISCELLANEOUS.*

## PLATE XIX

### MISCELLANEOUS

	PAGE
Fig. 1. Anguillula. $\times 100$ .....	384
“ 2. Nais. $\times 10$ .....	384
“ 3. Chætonotus. $\times 250$ .....	384
“ 4. Macrobiotus. $\times 250$ .....	384
“ 5. Acarina. $\times 25$ .....	384
“ 6. Hydra. $\times 25$ .....	384
“ 7. Batrachospermum. $\times 100$ .....	384
“ 8. Chara. $\times 75$ .....	384
“ 9. Anacharis. $\times 1$ .....	384
“ 10. Ceratophyllum. $\times 1$ .....	384
“ 11. Potamogeton. $\times 1$ .....	384
“ 12. Lemna. $\times 1$ .....	384

